

BCYF Clougherty Pool

Pool Replacement and Bathhouse Renovations

Public Meeting 1

Feb. 13, 2023



introduction & existing condition

**introduction &
existing condition**

project team

timeline overview

site overview

existing site plan

project scope

- **Mayor's Office of Neighborhood Services**
- **Charlestown Community**
- **BCYF**
- **City of Boston Public Facilities Department**
- **Fennick McCredie Architecture**
- **Weston & Sampson**
- **Consultants and Engineers**

process + schedule

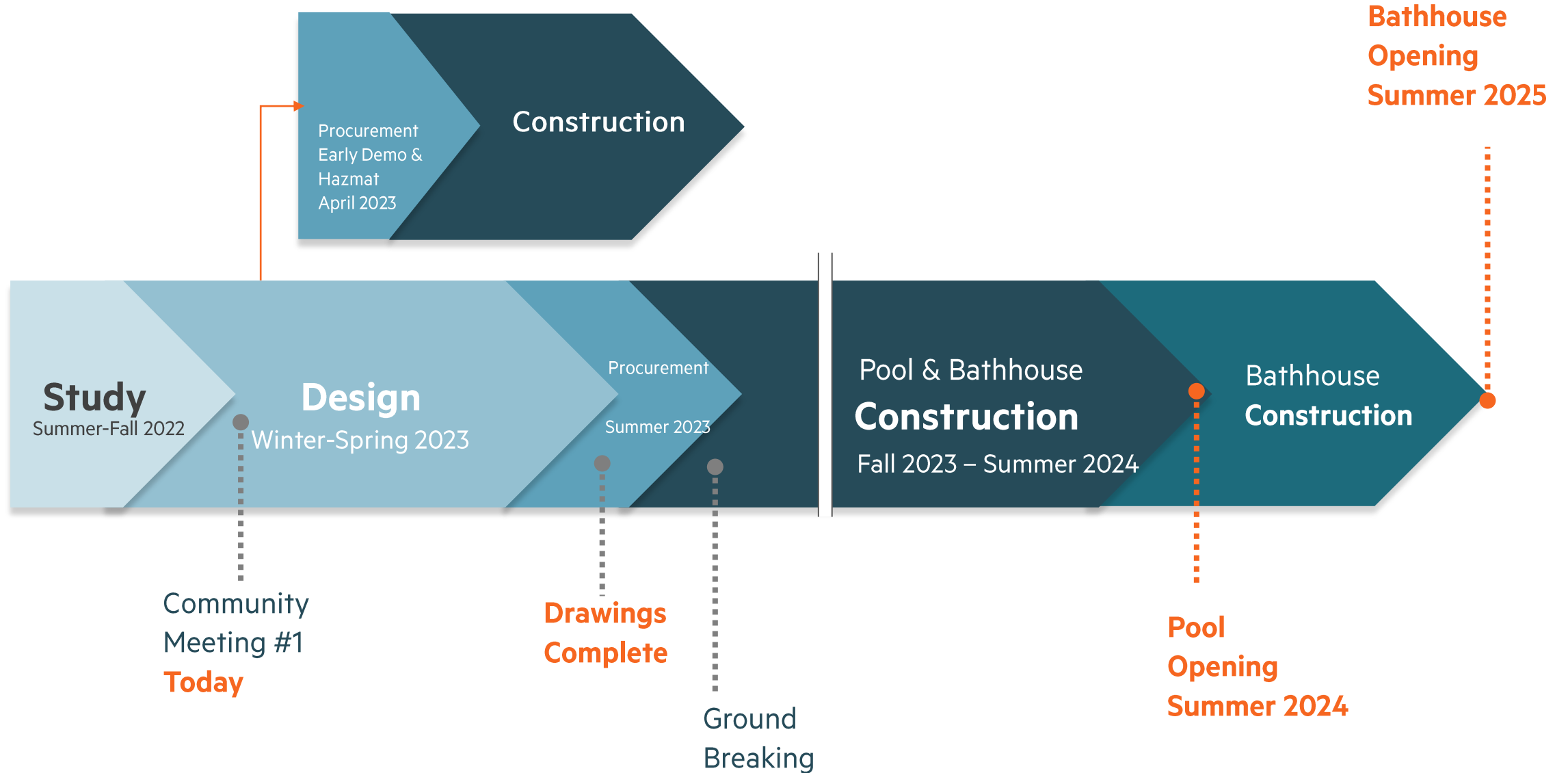

Site overview



Existing Conditions



Existing site plan

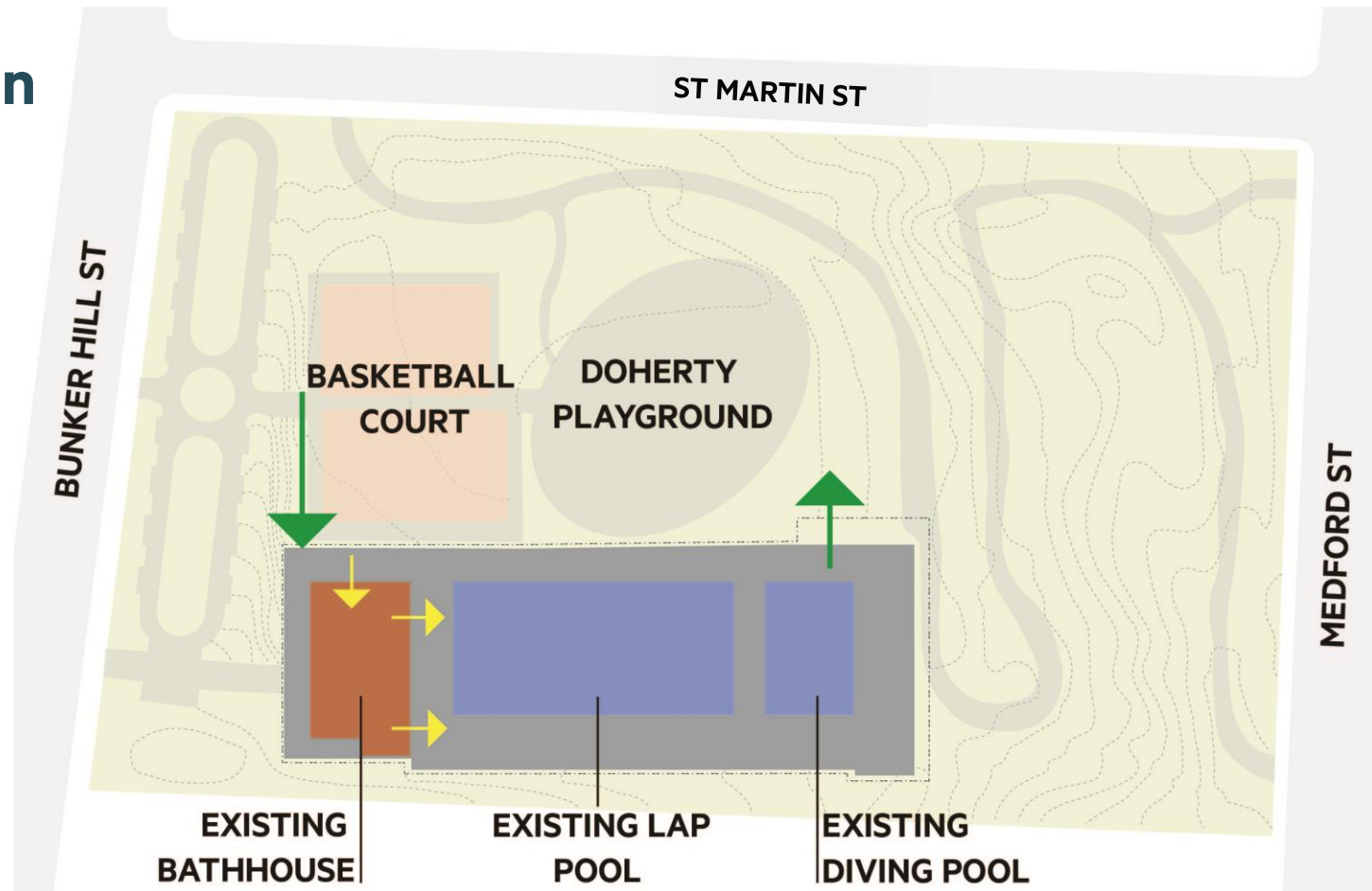

Project scope

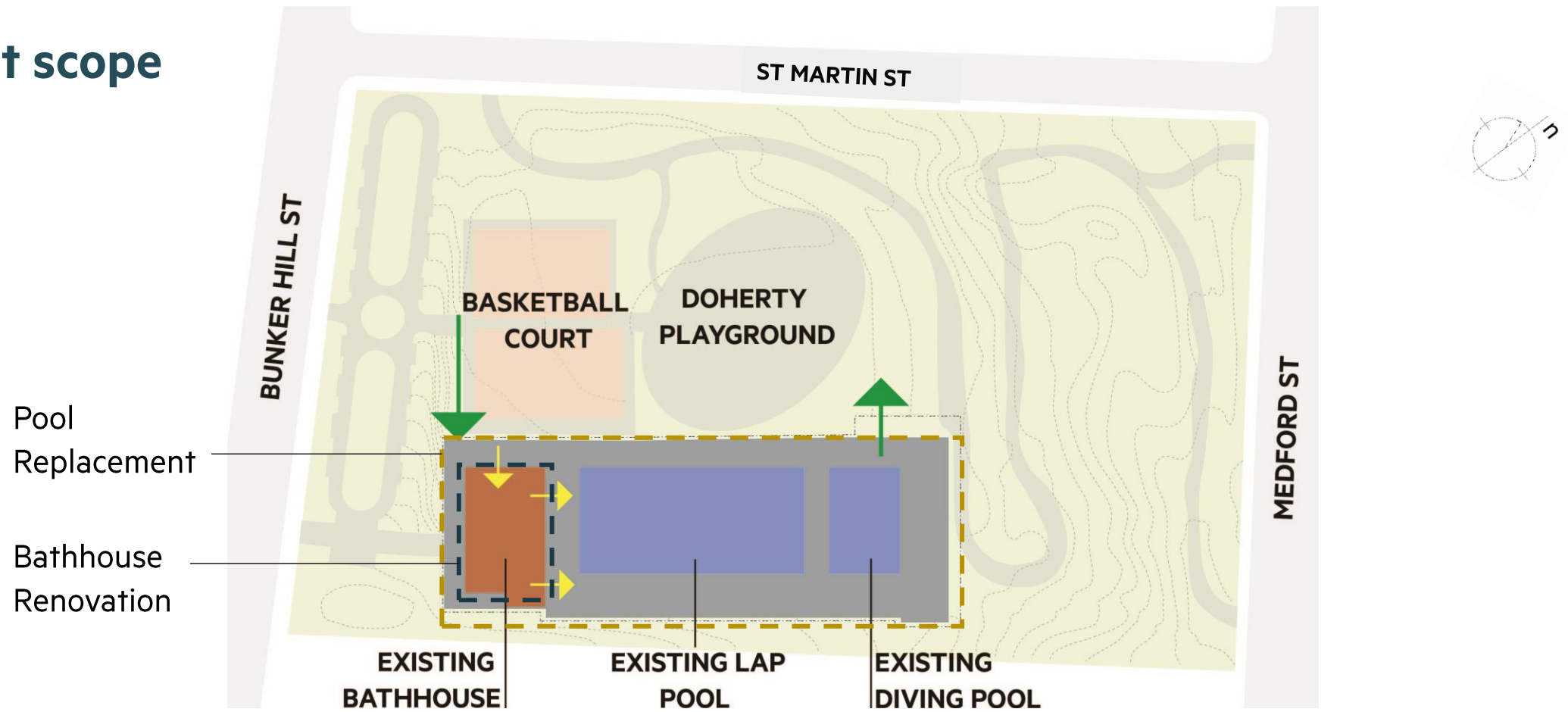



We Would Like Your Feedback On

- **Preferred Pool Design and Features**
- **Preferred Deck Design and Features**
- **Bathhouse Design and Features**



Pool design

Existing Conditions

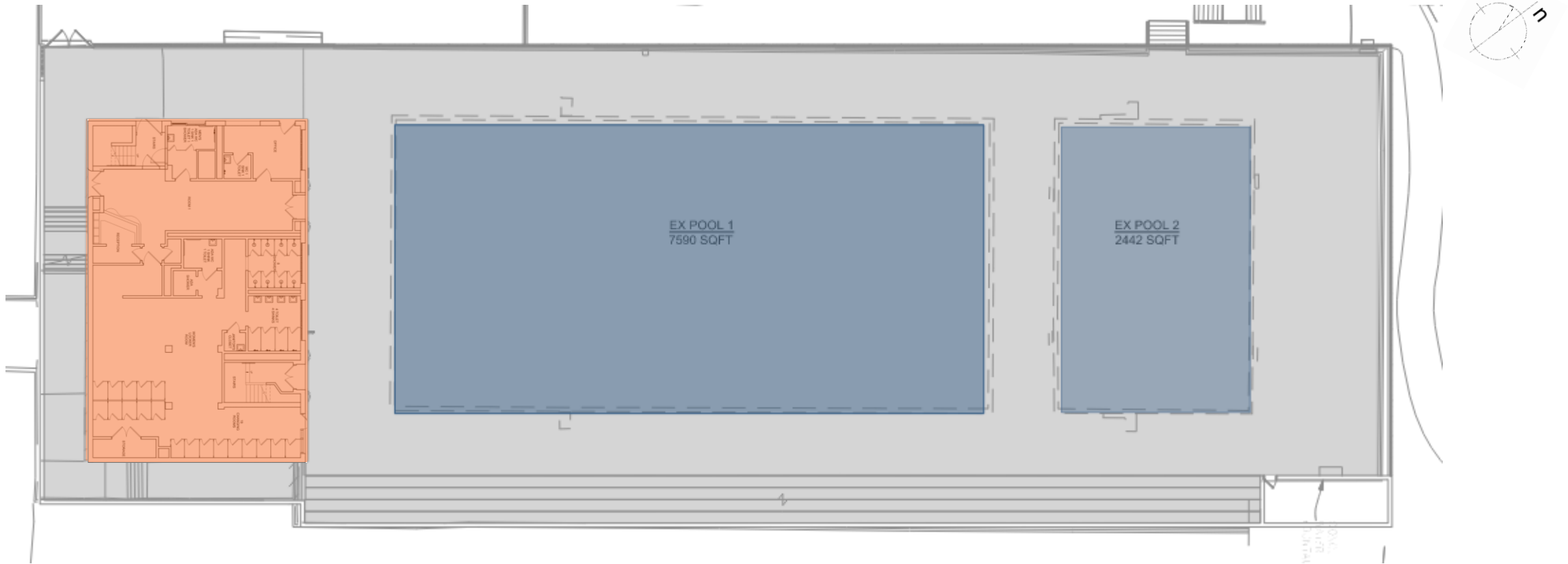

- Current pool 7600 SF
- Current limited available programs:
 - Learn to swim
 - Lap Swim
 - General Recreation

Feature Considerations

- Learn To Swim
- ADA Accessibility
- Multi-Generational Pools
- Inclusive Play Areas
- Lap Swimming with the Potential for Future Competition
- Senior Aerobics and Programs
- Teen and Toddler Areas
- General Recreation
- Shade Areas



Pool Concept – Single Pool Option

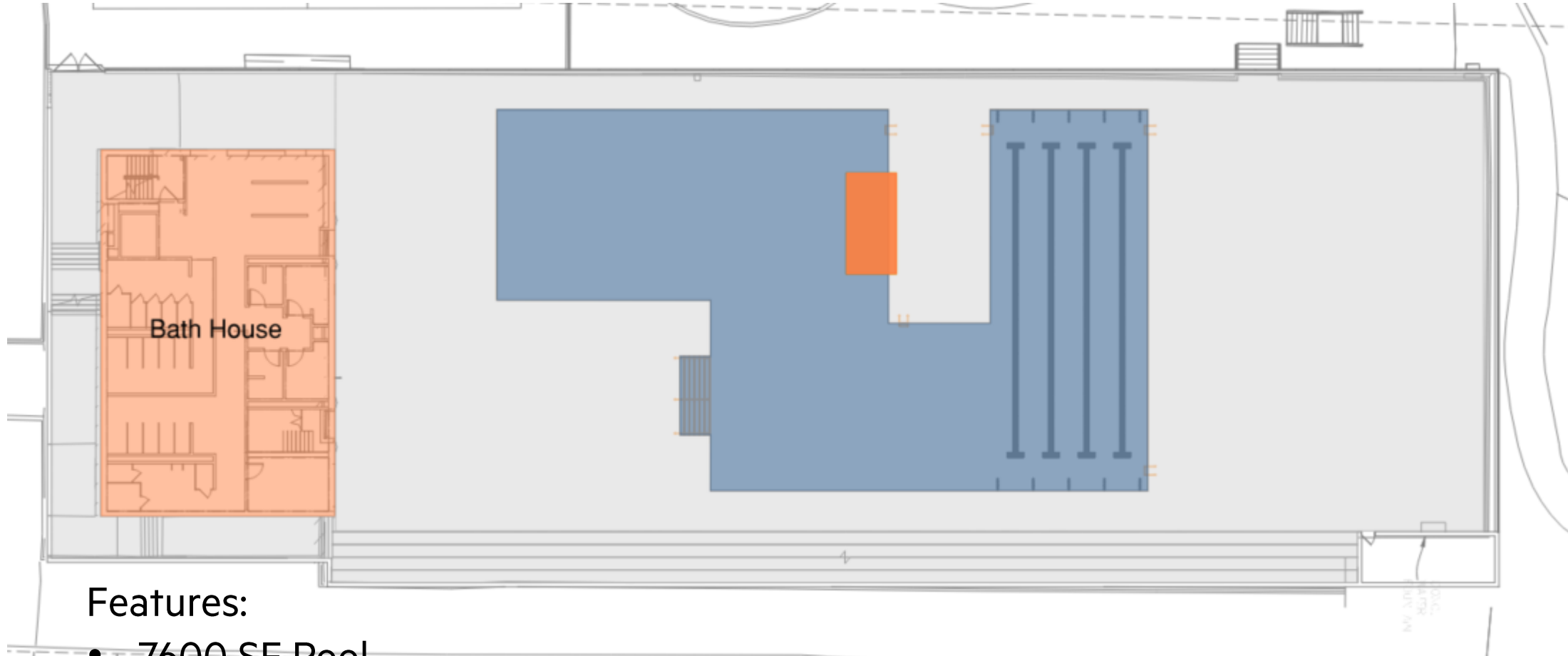

Features:

- 7600 SF Pool
- Depths from 0'-0" to 8' FT
- Zero Depth Entry with (4) Swim Lanes

Pool Concept – Two Pool Option #1

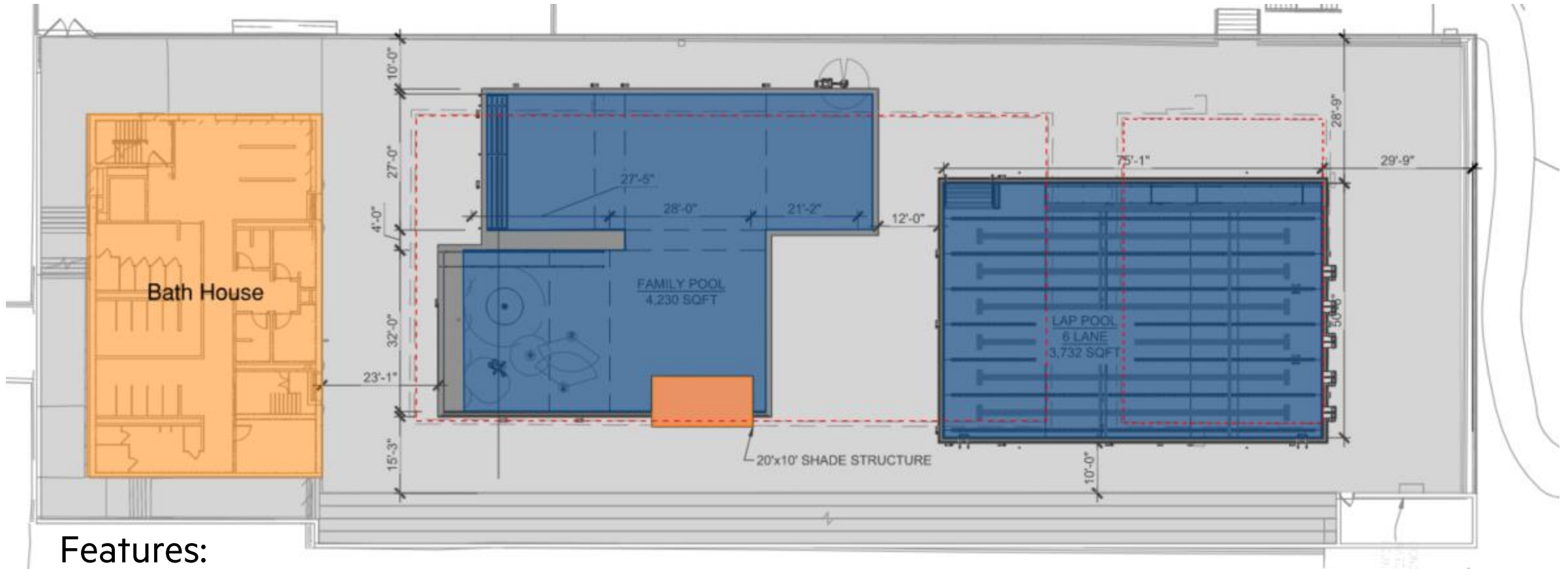

Features:

- 7960 SF Combined Water Surface
- Depths from 0'-0"- 3'-6" on Family Pool and 4'- 8' FT
- Zero Depth Entry with (6) Swim Lanes

Pool Concept – Two Pool Option #2

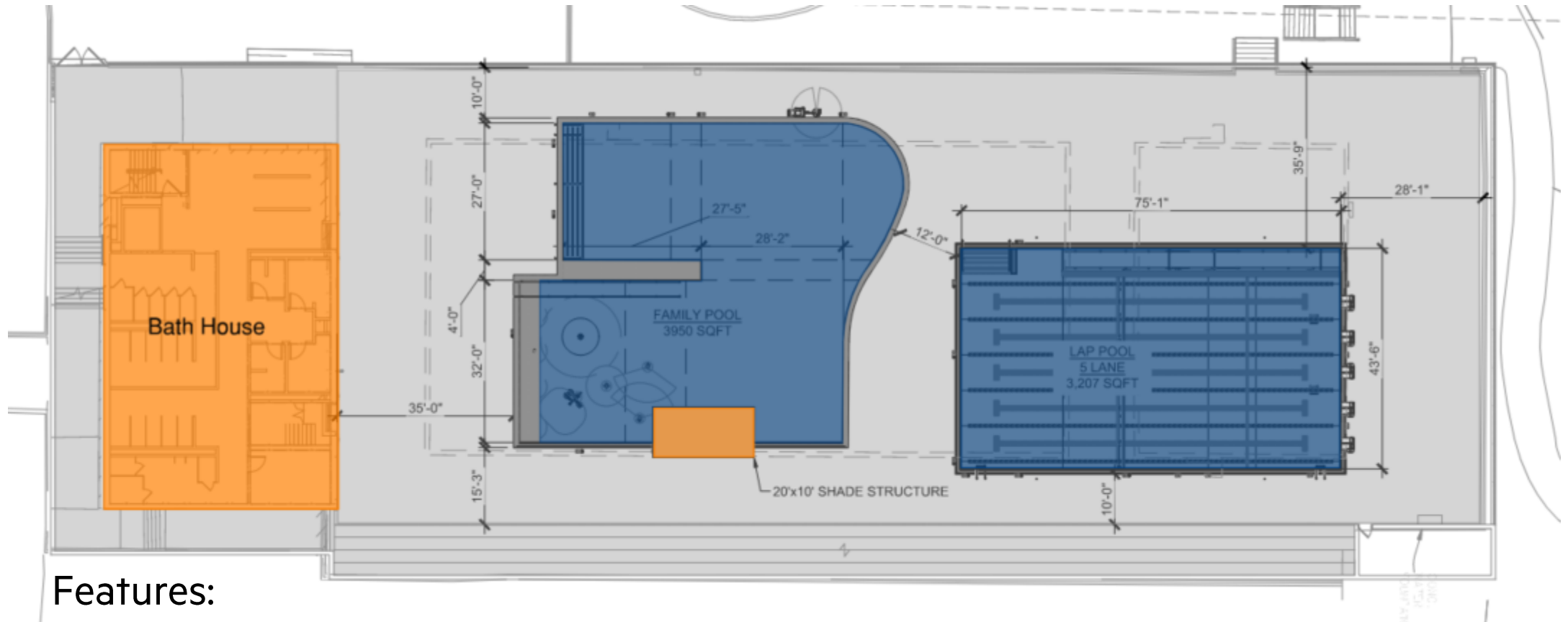

Features:

- 7200 SF Combined Water Surface
- Depths from 0'-0"- 3'-0" on Family Pool and 4'- 8' FT
- Zero Depth Entry with (5) Swim Lanes

Features – Zero Entry

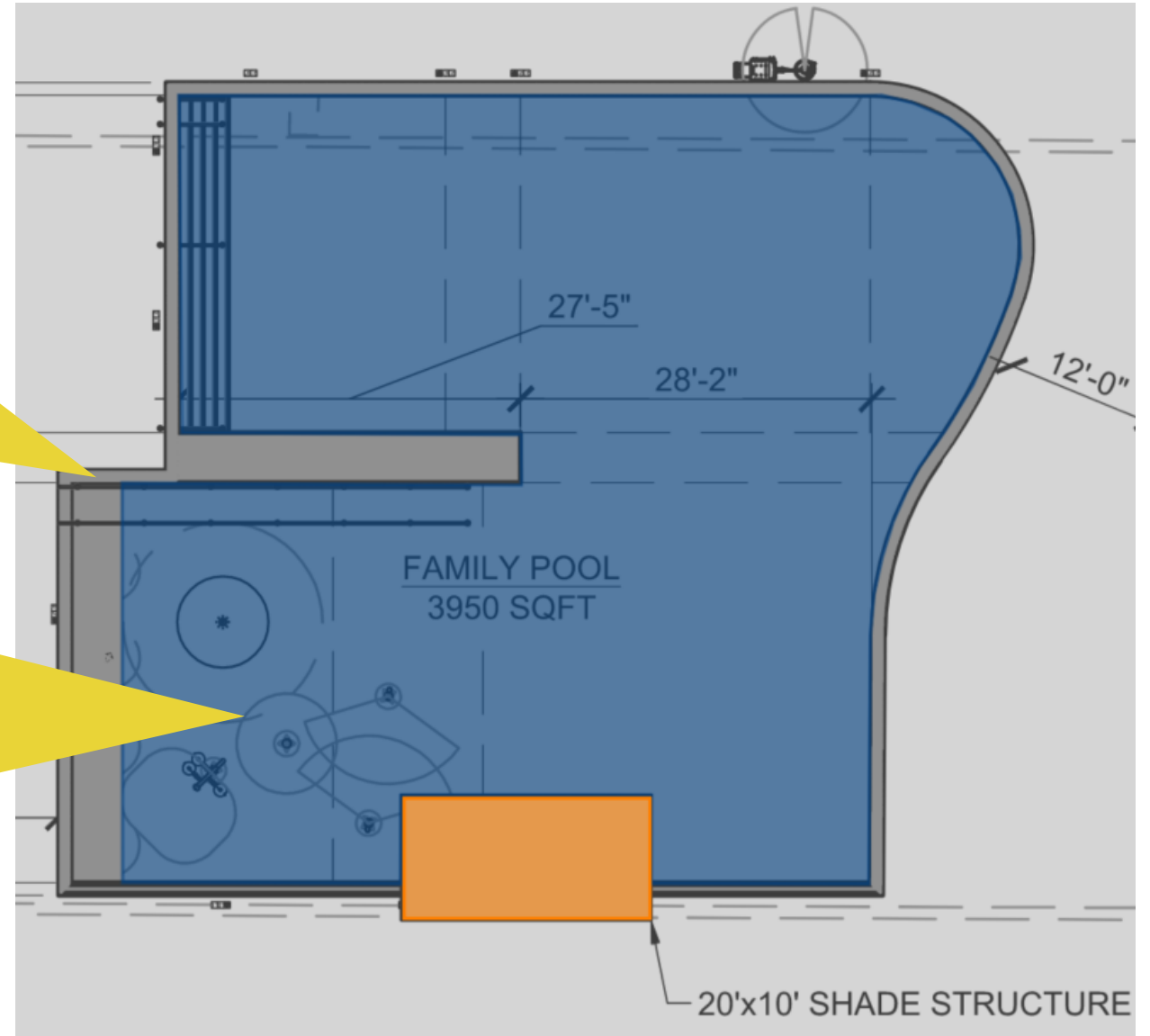

Features – Shade

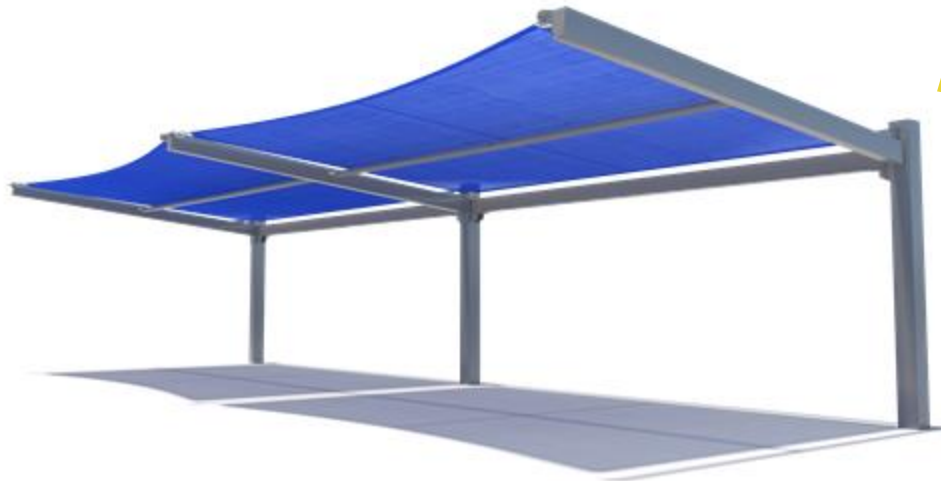
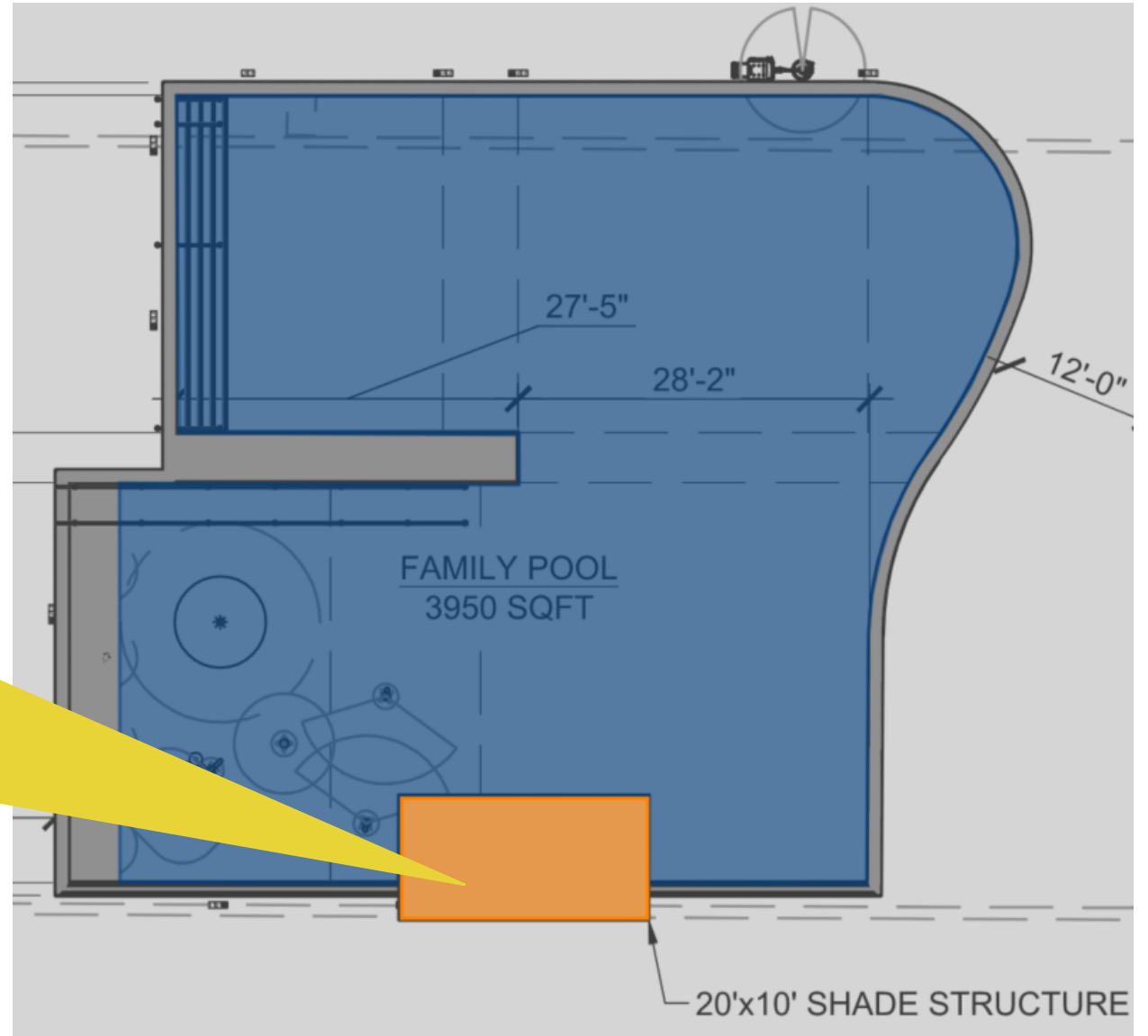

Features - Recreation

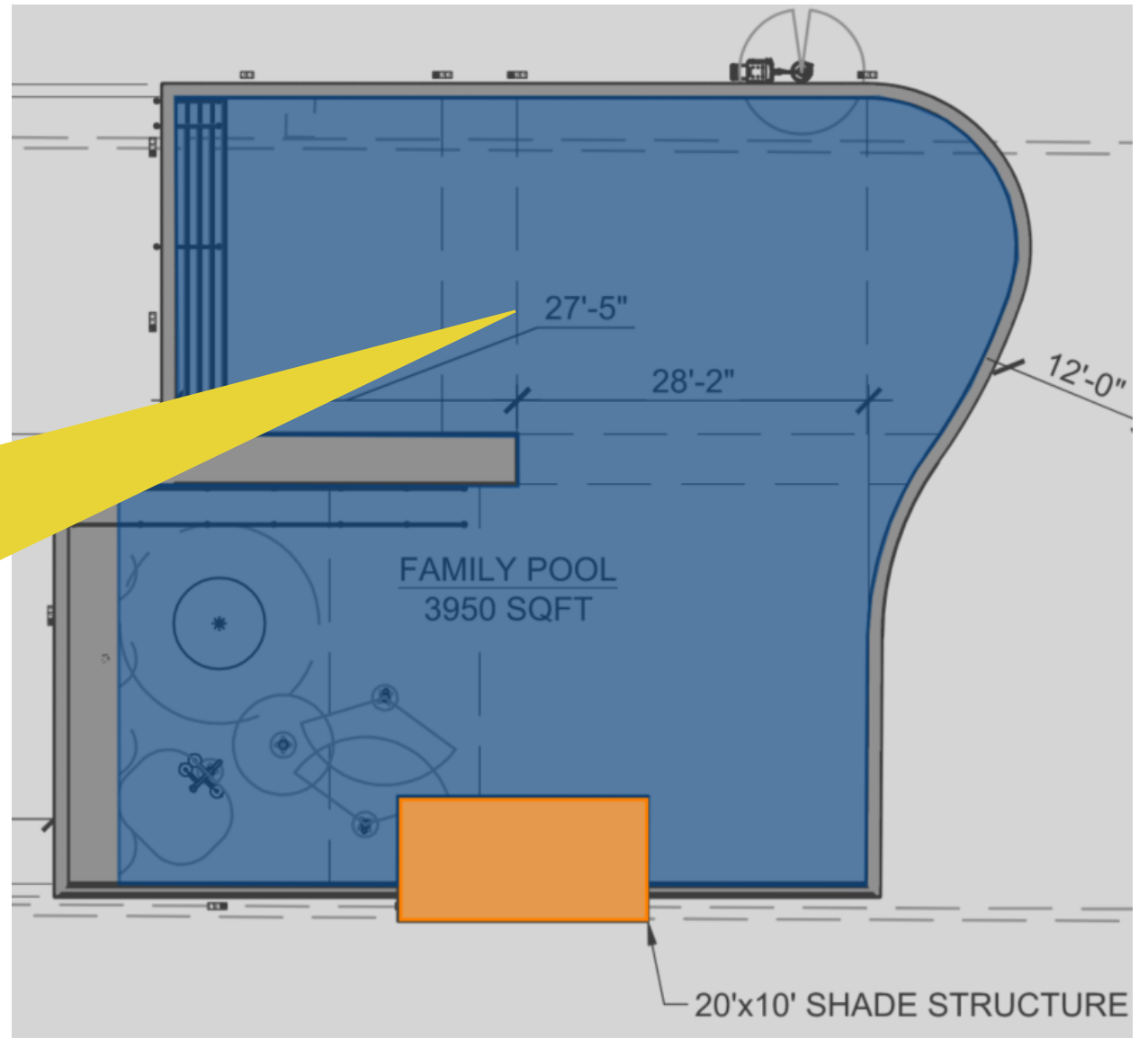

LAP POOL - ACCESSIBILITY

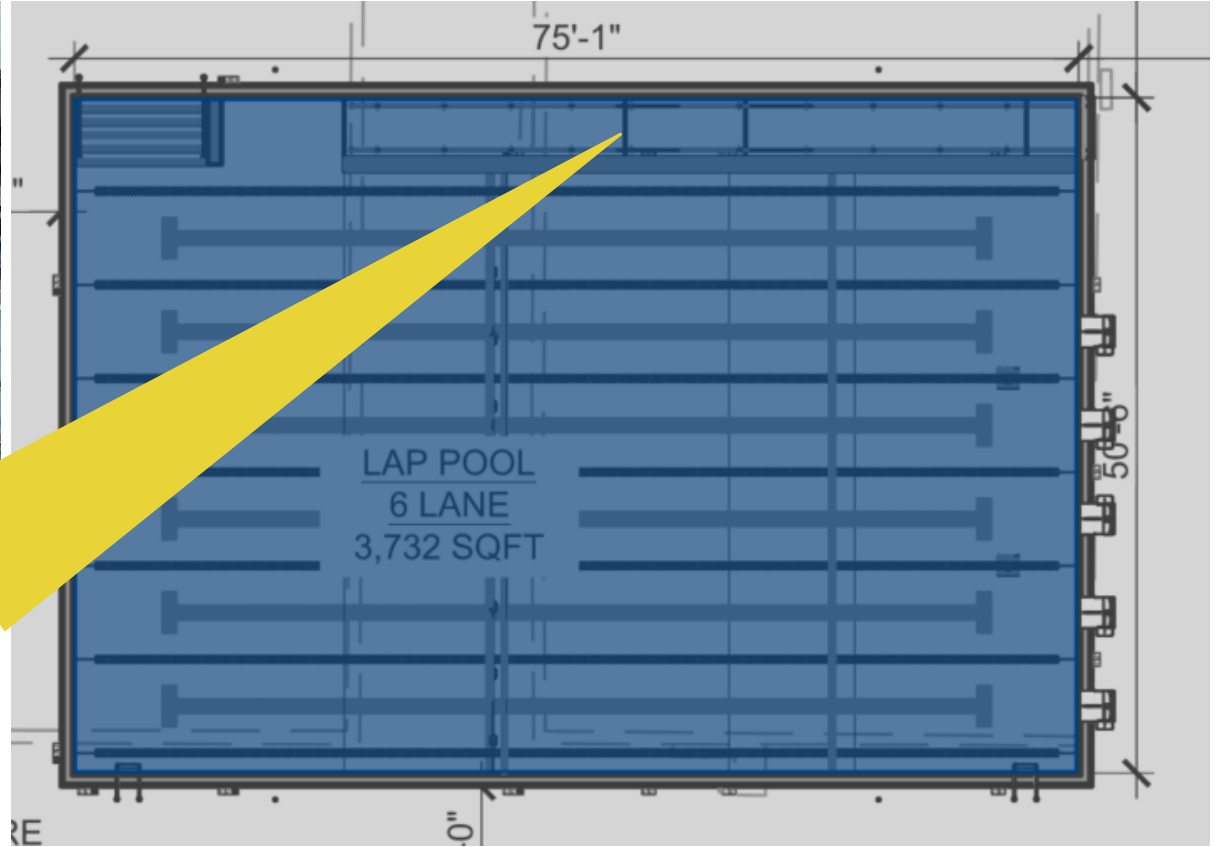

Lap Pool - Features

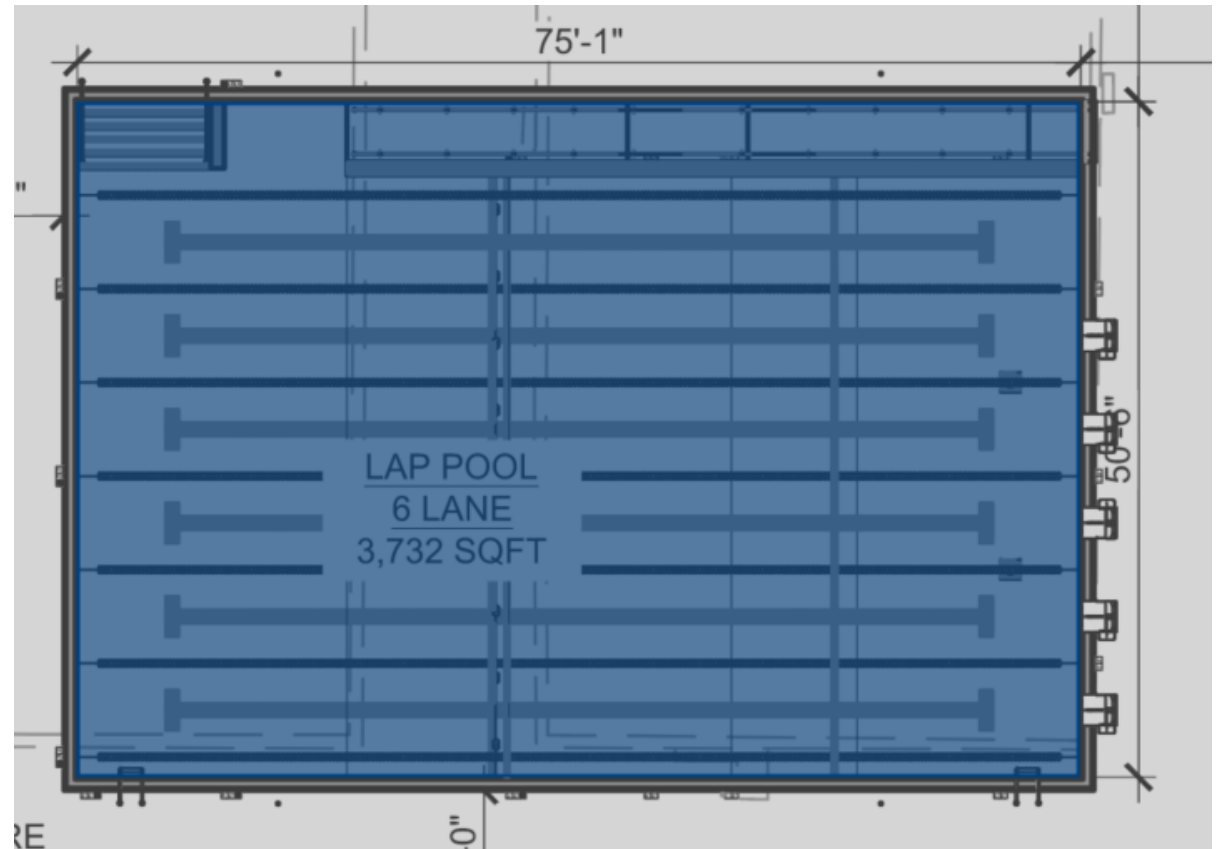

Lap Pool - Features

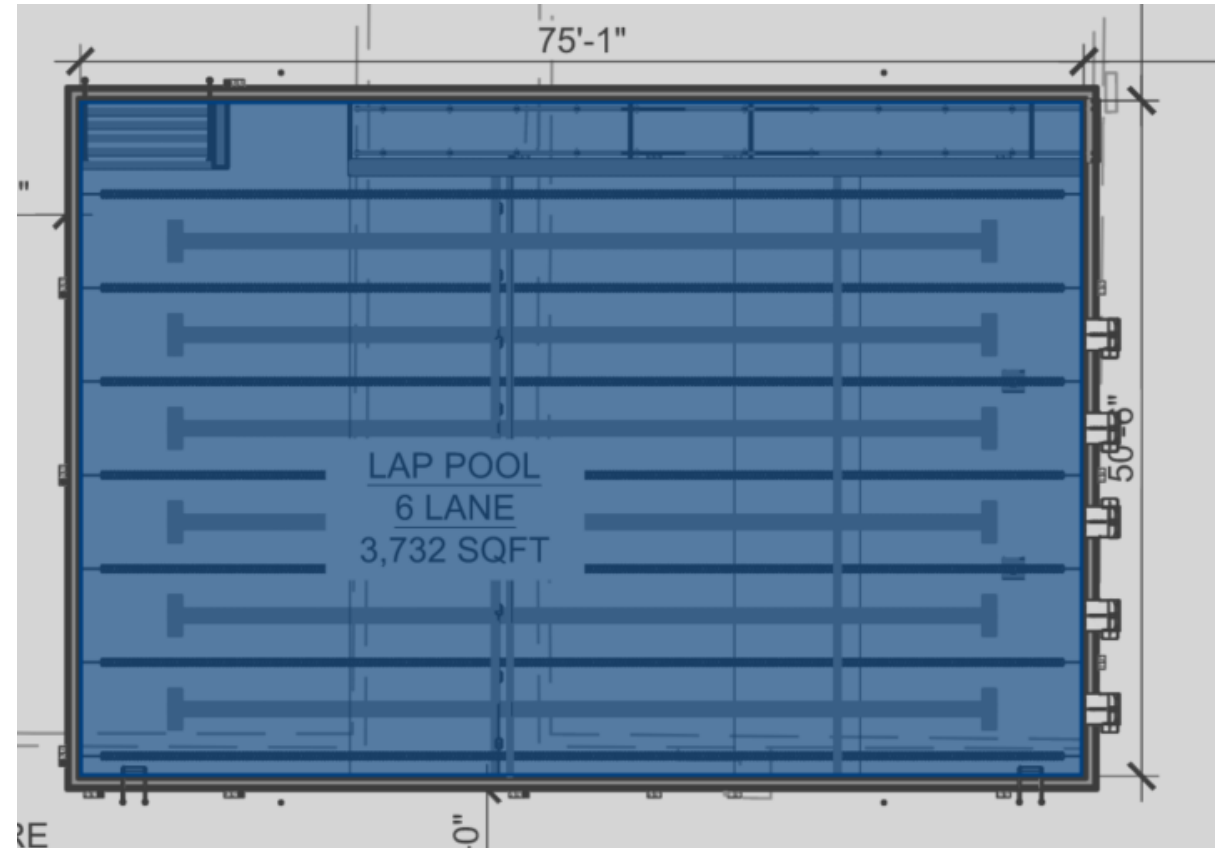



Pool deck design

Precedent Imagery - Surface



Precedent Imagery - Seating



Precedent Imagery - Shade



Pool Deck Design Option 1 - Plan

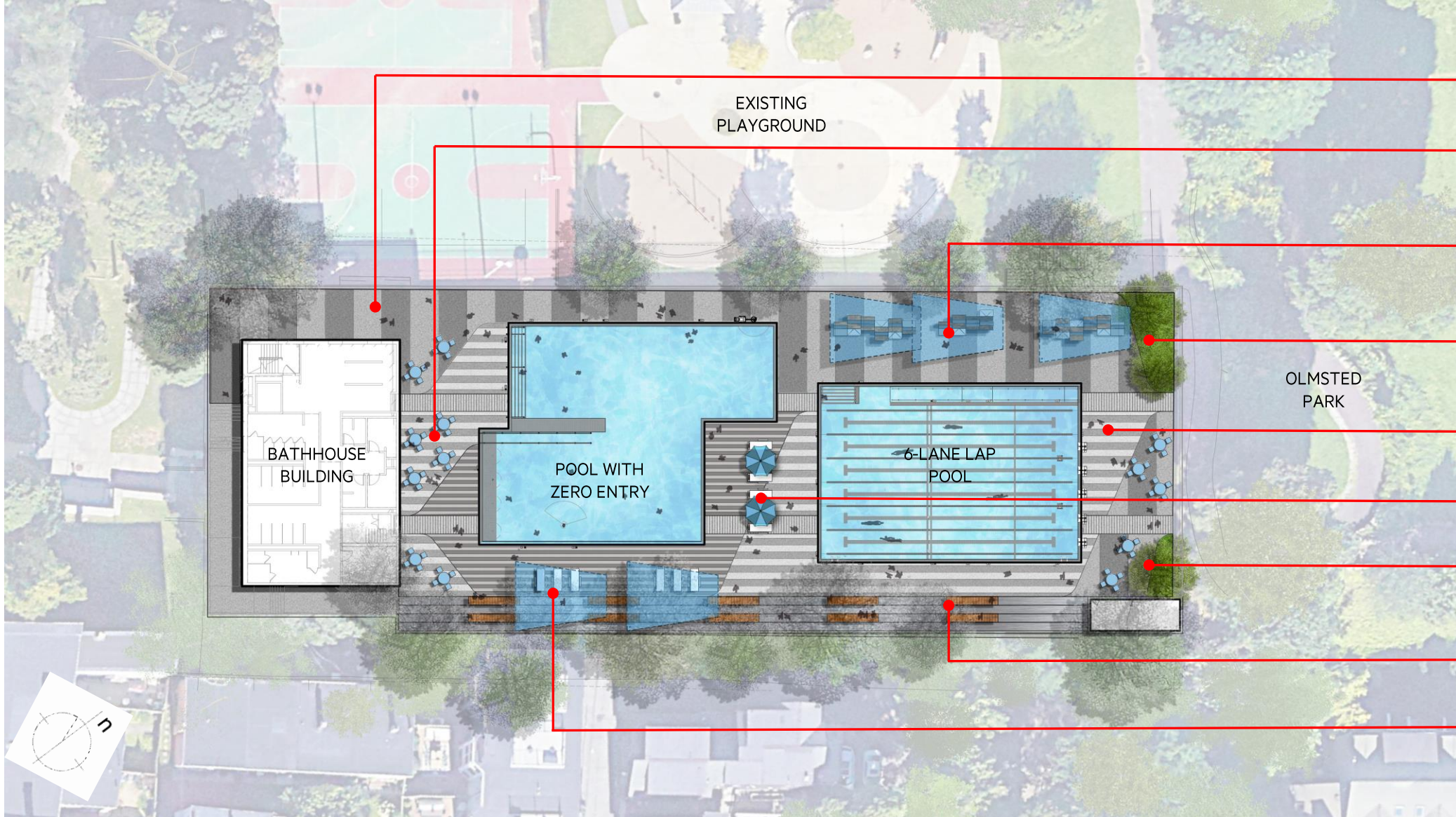

- COLORED CONCRETE BANDING
- TABLE AND CHAIR SEATING DEFINED BY BANDS OF UNIT PAVERS
- TENSILE SHADE STRUCTURE WITH SEATING BENEATH
- PLANTER WITH ORNAMENTAL TREE & PERENNIALS
- UNIT PAVERS ADD COLOR & VIBRANCY
- LOUNGE SEATING WITH UMBRELLAS
- PLANTER WITH ORNAMENTAL TREE & PERENNIALS
- WOOD SEAT AT CONCRETE BLEACHER
- TENSILE SHADE STRUCTURE WITH SEATING BENEATH

Pool Deck Design Option 1 - Perspective

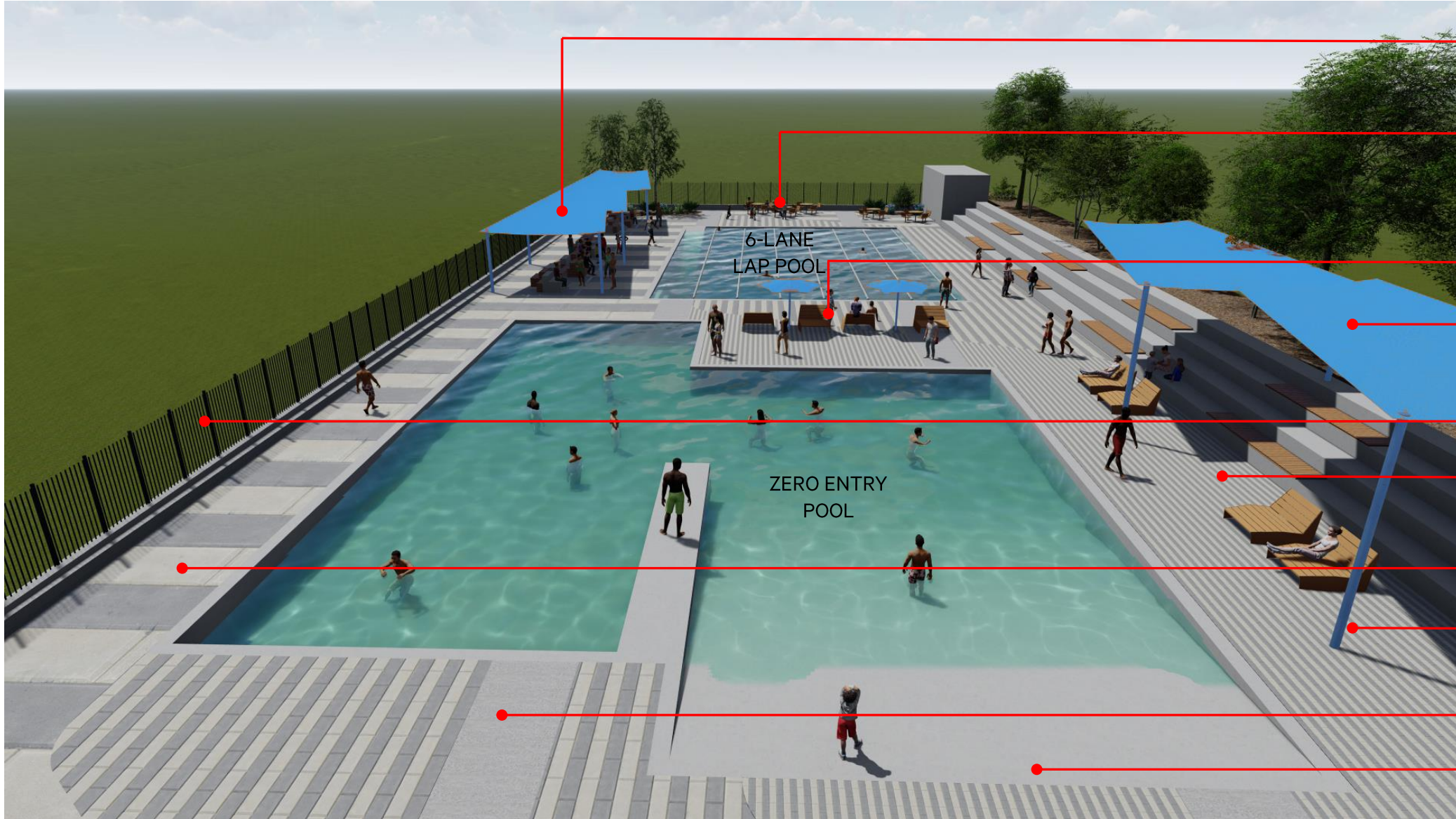

6-LANE
LAP POOL

ZERO ENTRY
POOL

- TENSILE SHADE STRUCTURE WITH SEATING BENEATH
- FIXED SEATING FOR FLEXIBLE USES
- LOUNGE SEATING WITH UMBRELLAS
- TENSILE SHADE STRUCTURE ABOVE BLEACHERS
- FENCING
- FIXED SEATING FOR FLEXIBLE USES
- COLORED CONCRETE BANDING
- CONCRETE UNIT PAVERS CREATE ZONES WITHIN THE POOL DECK
- COLORED CONCRETE BANDING
- ZERO ENTRY TO THE POOL

Pool Deck Design Option 1 - Perspective

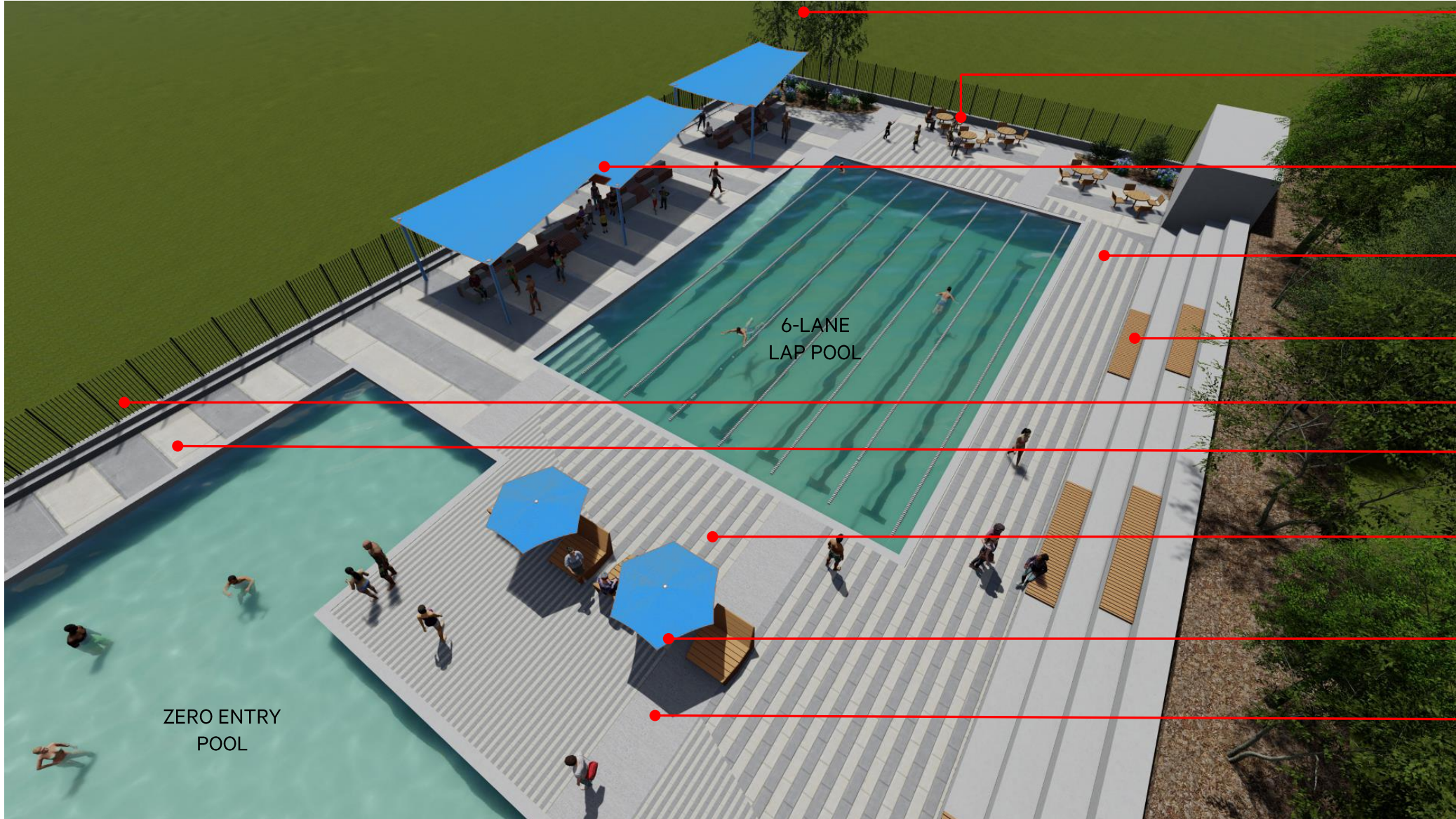

- PLANTER WITH ORNAMENTAL TREE
- TABLE AND CHAIR SEATING DEFINED BY BANDS OF UNIT PAVERS
- TENSILE SHADE STRUCTURE WITH FIXED SEATING BENEATH
- CONCRETE UNIT PAVERS CREATE ZONES WITHIN THE POOL
- WOOD SEAT AT CONCRETE BLEACHER
- FENCING
- COLORED CONCRETE BANDING
- CONCRETE UNIT PAVERS CREATE ZONES WITHIN THE POOL DECK
- FIXED LOUNGE SEATING WITH UMBRELLAS
- COLORED CONCRETE BANDING

Pool Deck Design Option 1 - Perspective

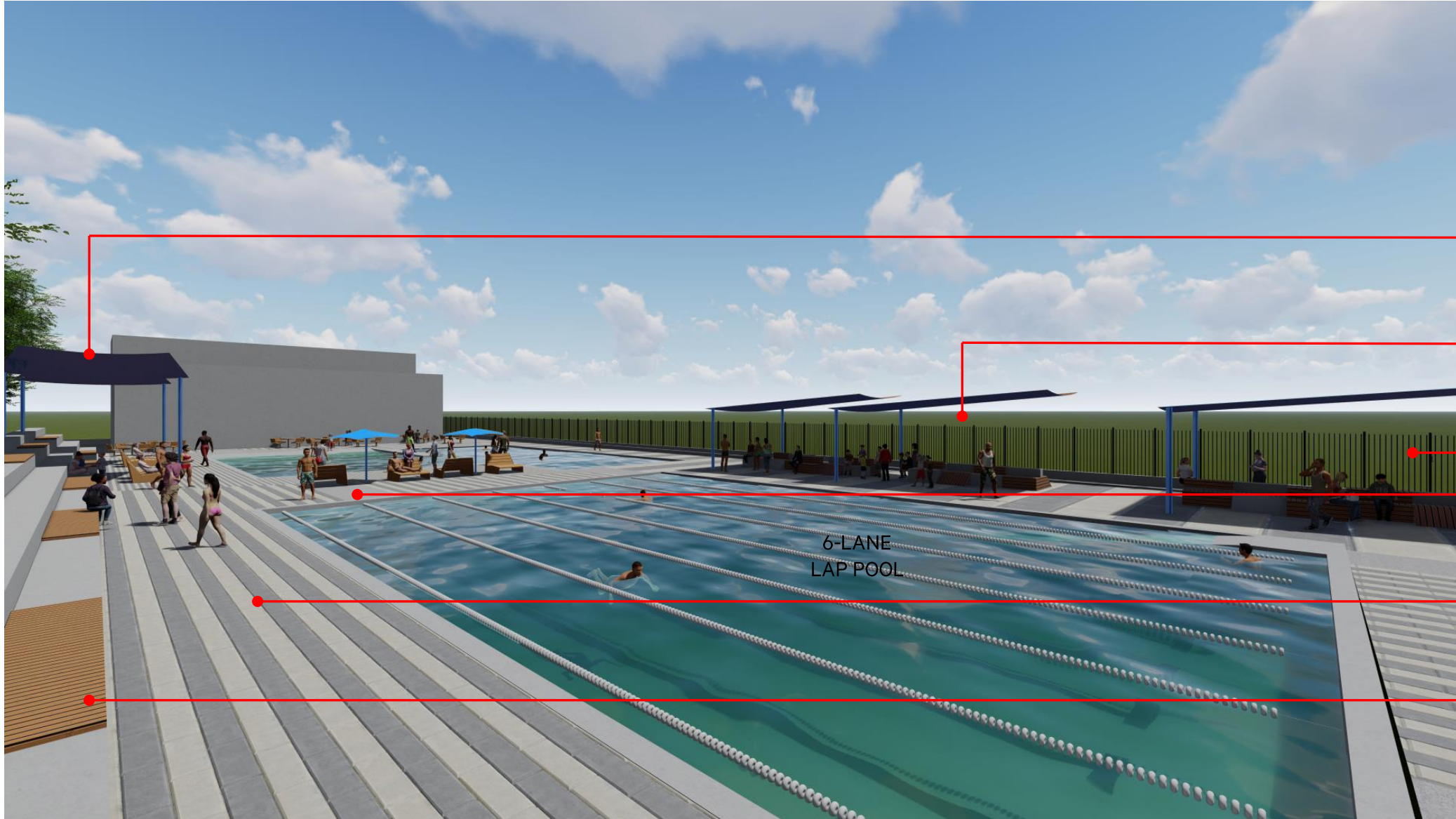

6-LANE
LAP POOL

- TENSILE SHADE STRUCTURE OVER EXISTING BLEACHERS
- TENSILE SHADE STRUCTURE WITH FIXED SEATING BENEATH
- FENCING
- FIXED LOUNGE SEATING WITH UMBRELLAS
- CONCRETE UNIT PAVERS CREATE ZONES WITHIN THE POOL DECK
- WOOD SEAT AT CONCRETE BLEACHER

Pool Deck Design Option 1 - Perspective

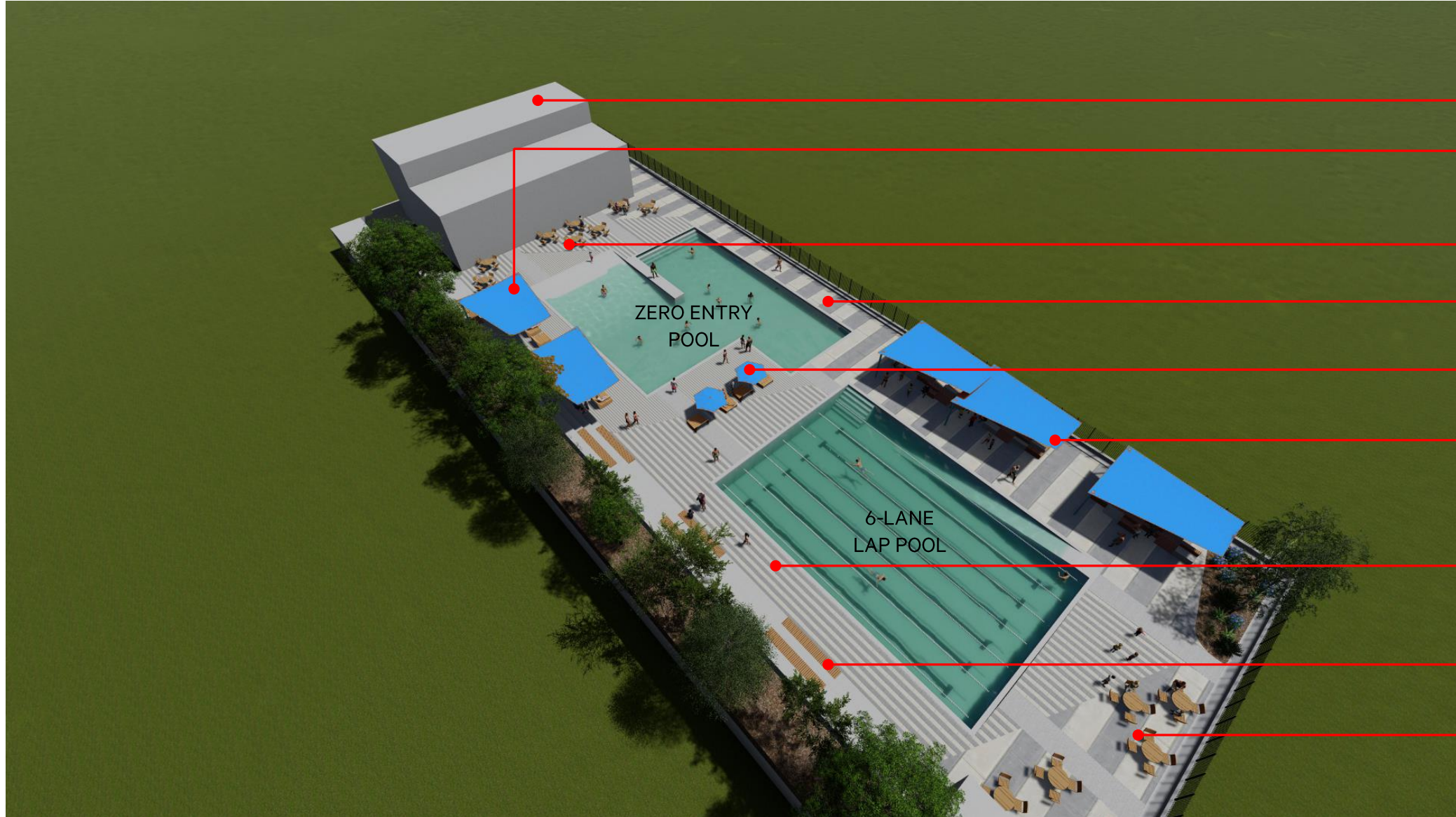

- POOL BUILDING
- TENSILE SHADE STRUCTURE OVER EXISTING BLEACHERS
- FIXED LOUNGE SEATING
- COLORED CONCRETE BANDS
- FIXED LOUNGE SEATING WITH UMBRELLAS
- TENSILE SHADE STRUCTURE WITH FIXED SEATING BENEATH
- CONCRETE UNIT PAVERS CREATE ZONES WITHIN THE POOL DECK
- WOOD SEAT AT CONCRETE BLEACHER
- FIXED LOUNGE SEATING

Pool Deck Design Option 2 - Plan

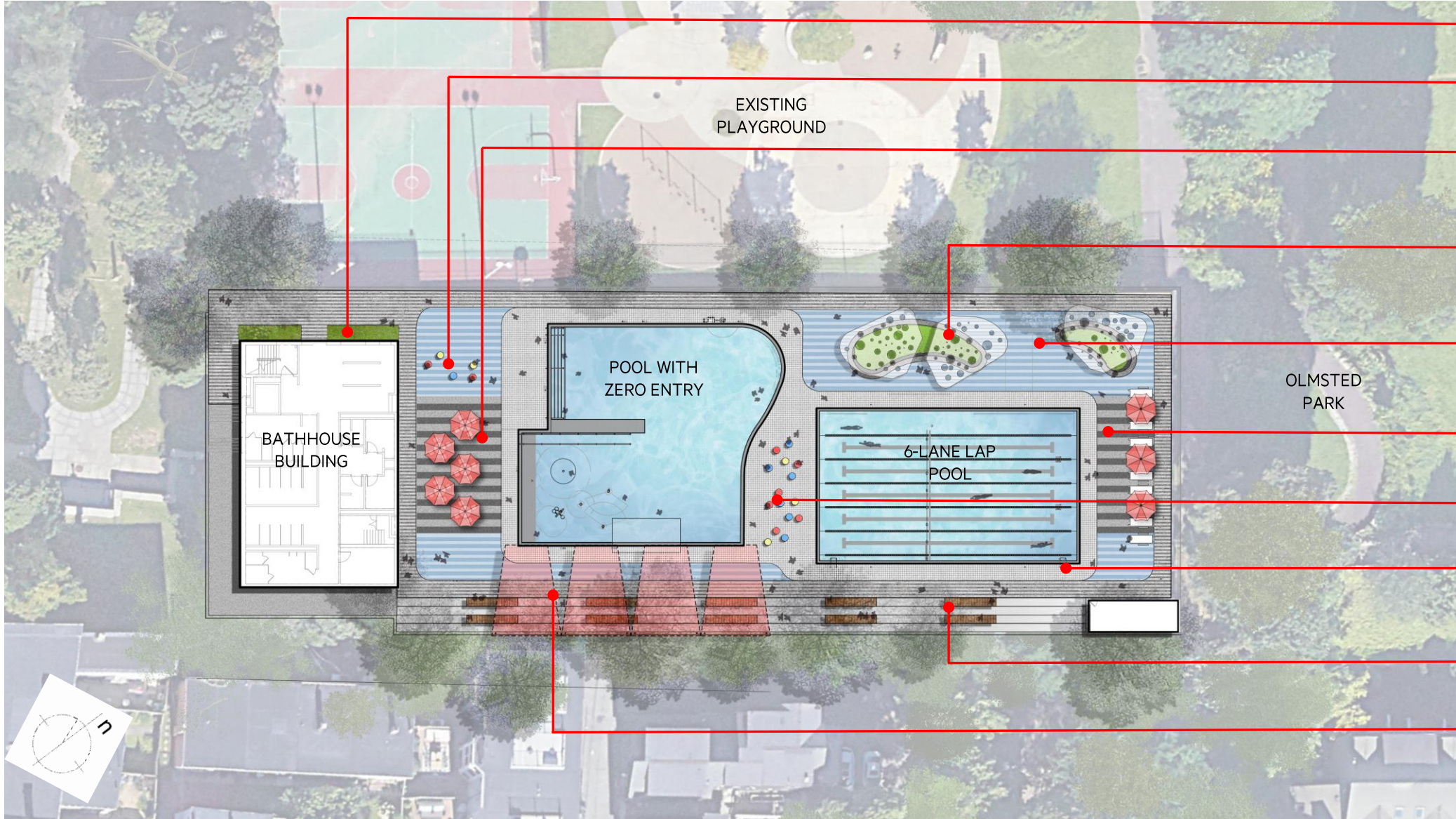

- PLANTER AT BUILDING FACADE
- COLORFUL SEATING PODS
- TABLE AND CHAIR SEATING DEFINED BY BANDS OF UNIT PAVERS
- SHADE STRUCTURE WITH SEATING & PLANTER BENEATH
- COLORFUL PAVERS DELINEATE THE SEATING AREA
- UNIT PAVERS DEFINE SEATING AREA
- COLORFUL SEATING PODS
- PAVING HELPS TO DEFINE POOL WARNING TRACK
- WOOD SEAT AT CONCRETE BLEACHER
- TENSILE SHADE STRUCTURE WITH SEATING BENEATH

Pool Deck Design Option 2 - Perspective

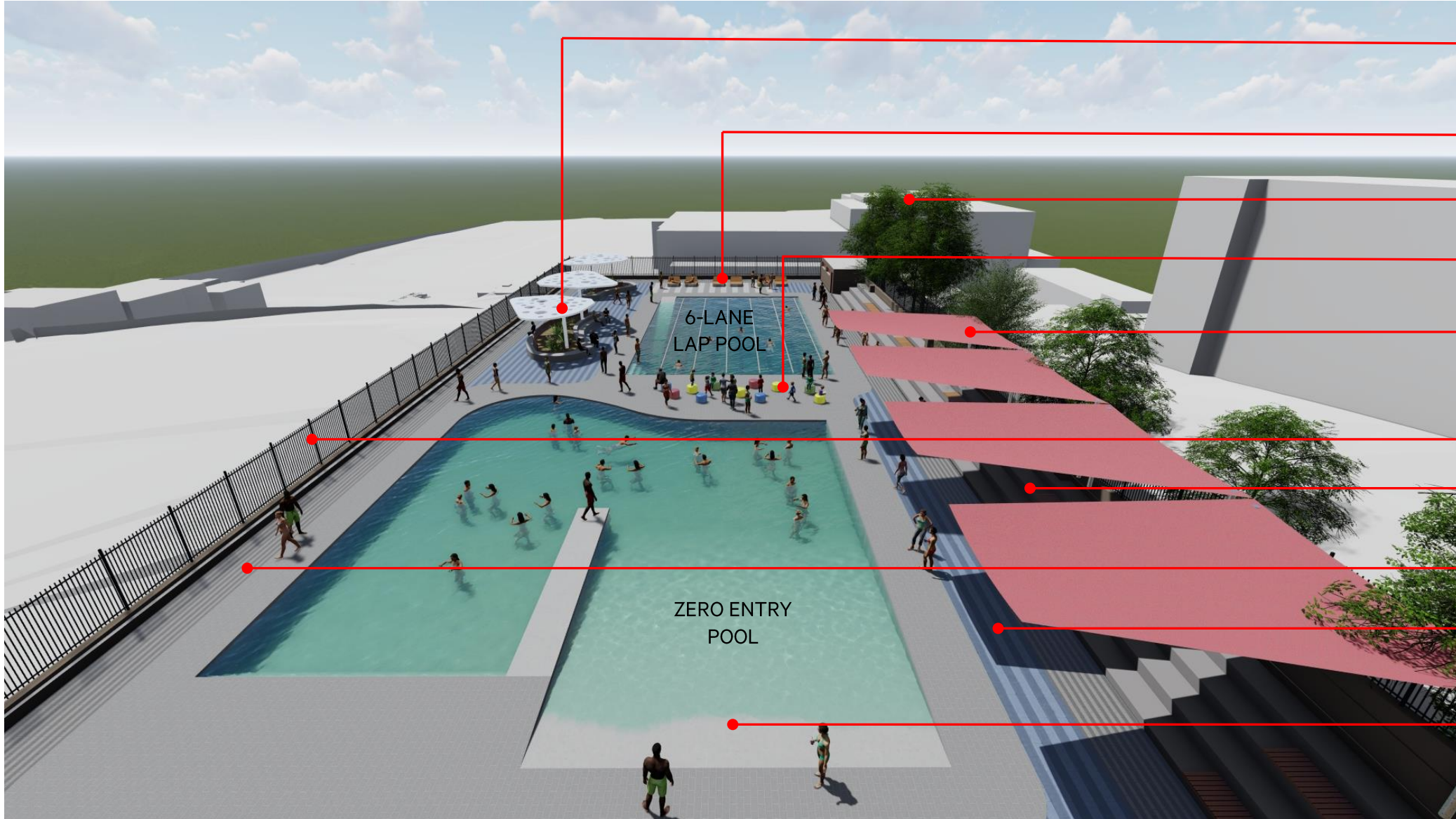

- SHADE STRUCTURE WITH SEATING & PLANTING BENEATH
- FIXED SEATING FOR FLEXIBLE USES
- EXISTING TREES TO REMAIN
- COLORFUL SEATING PODS
- TENSILE SHADE STRUCTURE ABOVE BLEACHERS
- FENCING
- WOOD SEAT AT CONCRETE BLEACHERS
- COLORLED CONCRETE BANDING
- CONCRETE UNIT PAVERS CREATE ZONES WITHIN THE POOL DECK
- ZERO ENTRY TO THE POOL

Pool Deck Design Option 2 - Perspective

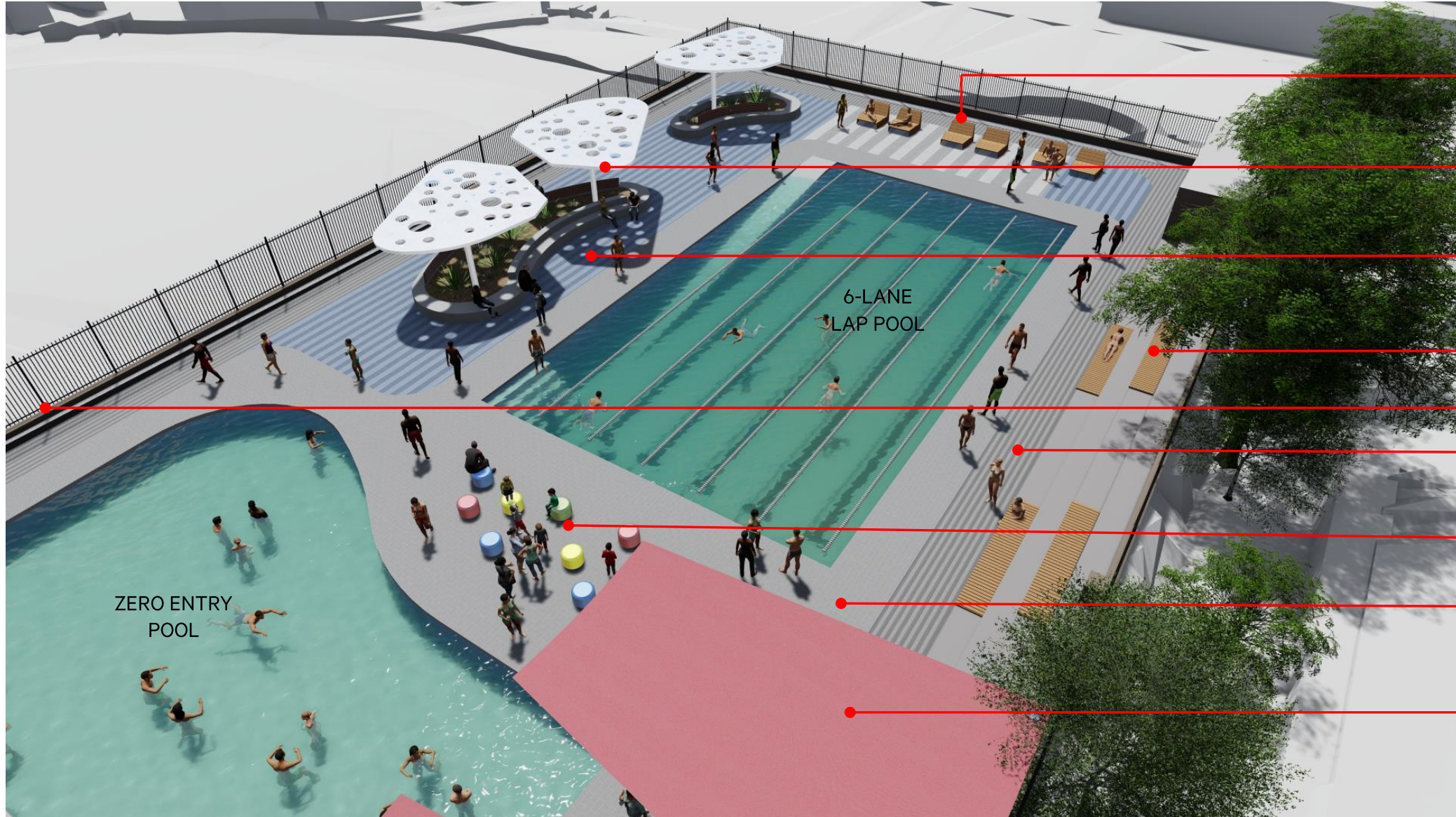

ZERO ENTRY POOL

6-LANE LAP POOL

- FIXED LOUNGE SEATING DEFINED BY BANDS OF UNIT PAVERS
- SHADE STRUCTURE WITH PLANTING & SEATING BENEATH
- CONCRETE UNIT PAVERS CREATE ZONES WITHIN THE POOL DECK
- WOOD SEAT AT CONCRETE BLEACHER
- FENCING
- COLORLED CONCRETE BANDING
- COLORFUL SEATING PODS
- COLORLED CONCRETE PAVERS
- TENSILE SHADE STRUCTURE OVER CONCRETE BLEACHERS

Pool Deck Design Option 2 - Perspective



6-LANE
LAP POOL

- TENSILE SHADE STRUCTURE OVER EXISTING BLEACHERS
- FIXED LOUNGE SEATING WITH UMBRELLAS
- POOL BUILDING
- FENCING
- SHADE STRUCTURE WITH SEATING & PLANTING BENEATH
- CONCRETE UNIT PAVERS CREATE ZONES WITHIN THE POOL DECK
- COLORFUL SEATING PODS
- WOOD SEAT AT CONCRETE BLEACHER

Pool Deck Design Option 2 - Perspective

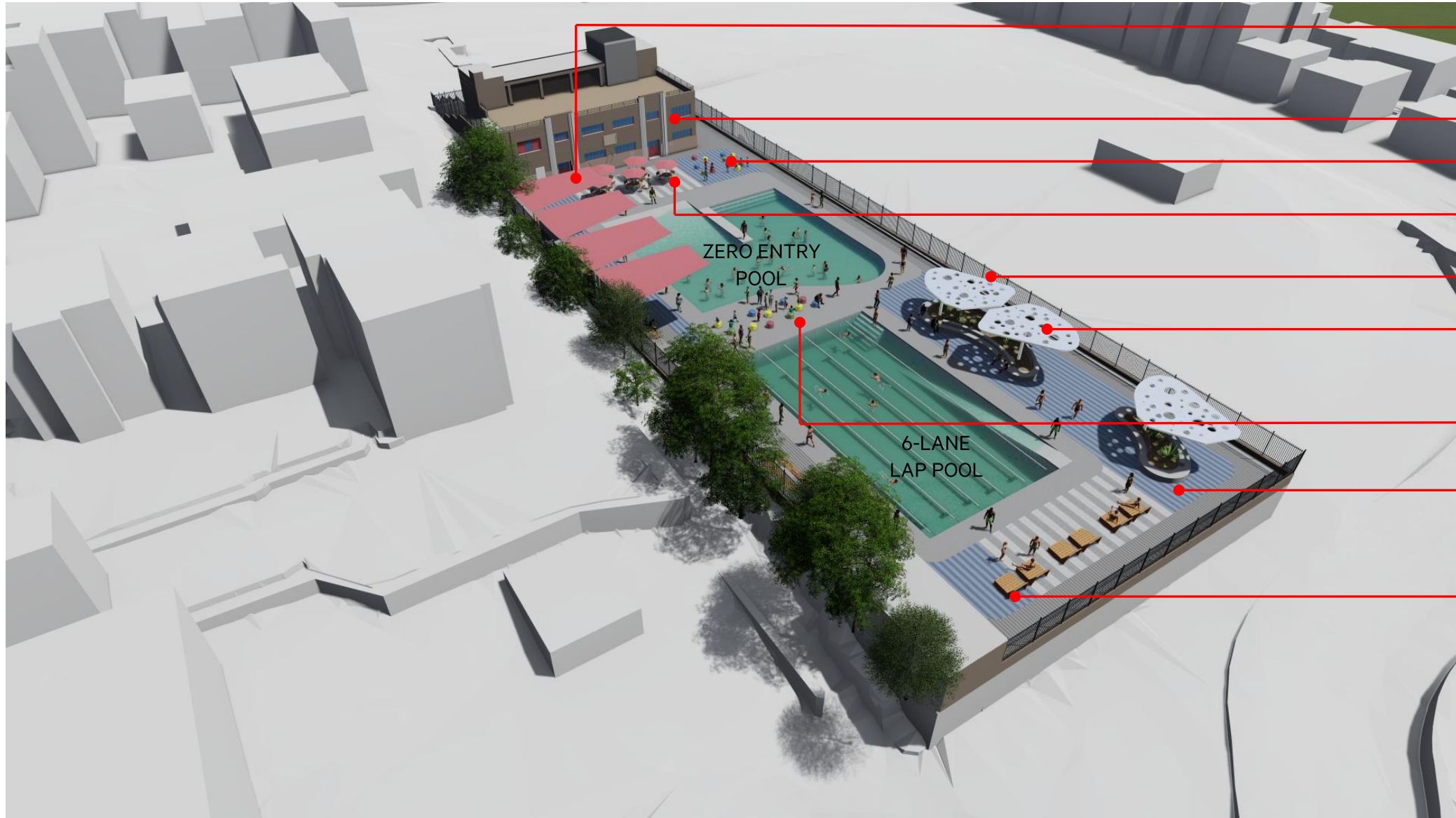

- TENSILE SHADE STRUCTURE OVER EXISTING BLEACHERS
- POOL BUILDING
- COLORFUL SEATING PODS
- FIXED LOUNGE SEATING WITH UMBRELLAS
- FENCING
- SHADE STRUCTURE WITH PLANTING & SEATING BENEATH
- COLORFUL SEATING PODS
- CONCRETE UNIT PAVERS CREATE ZONES WITHIN THE POOL DECK
- FIXED LOUNGE SEATING



Bathhouse

Bathhouse



existing building renovation

swimmer facilities

community amenities

Bathhouse

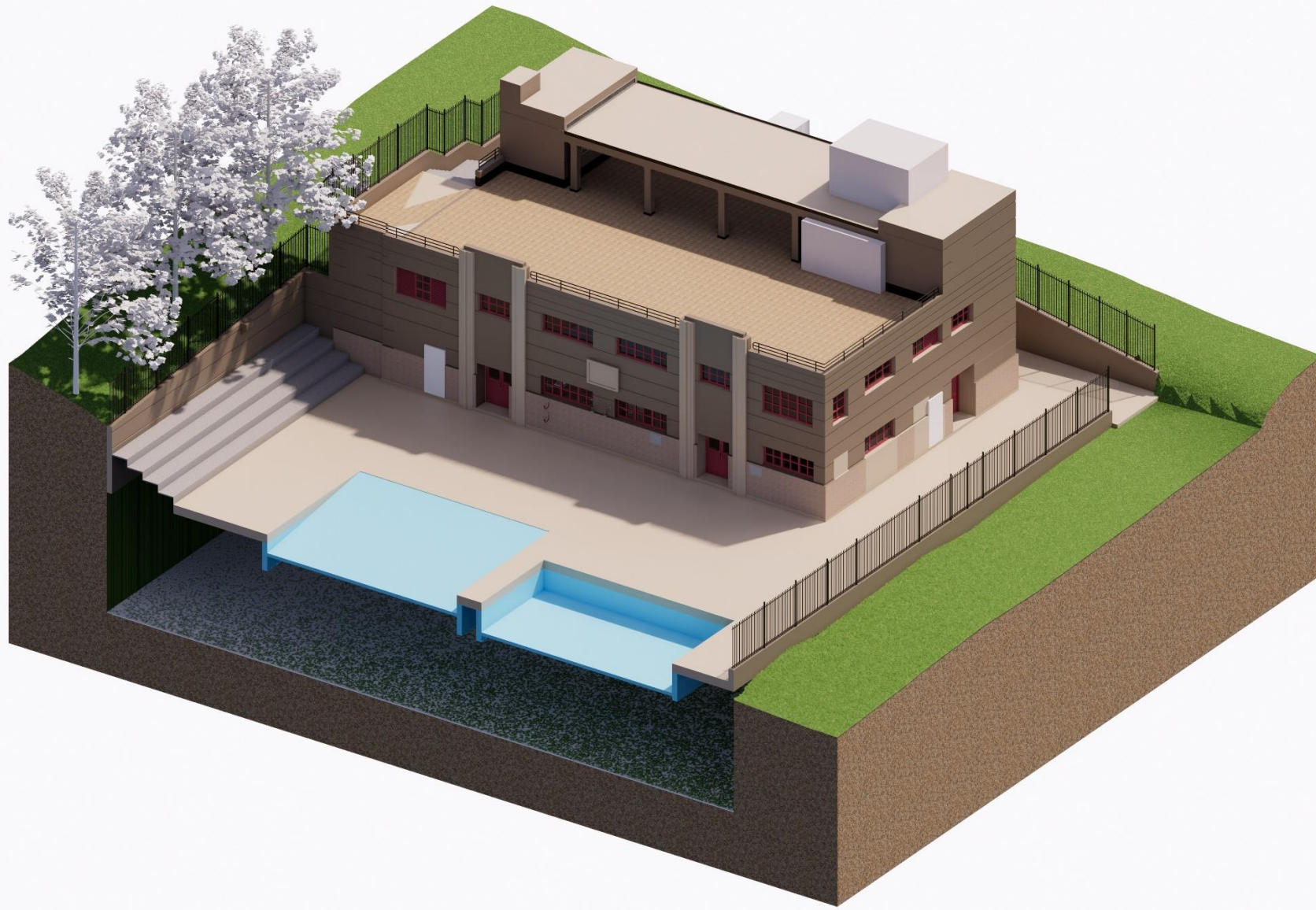

Bathhouse-level 1



- CIRCULATION
- LOCKER ROOMS
- ADMIN
- UTILITY
- COMMUNITY SPACE

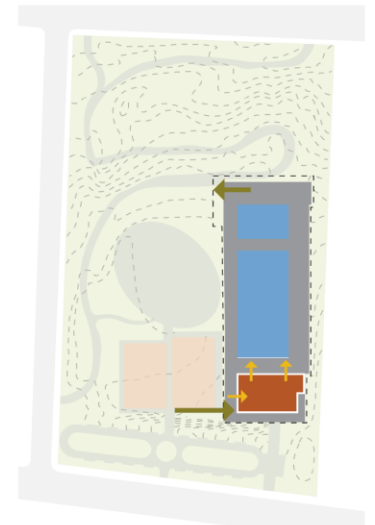

KEY PLAN

Bathhouse-level 2

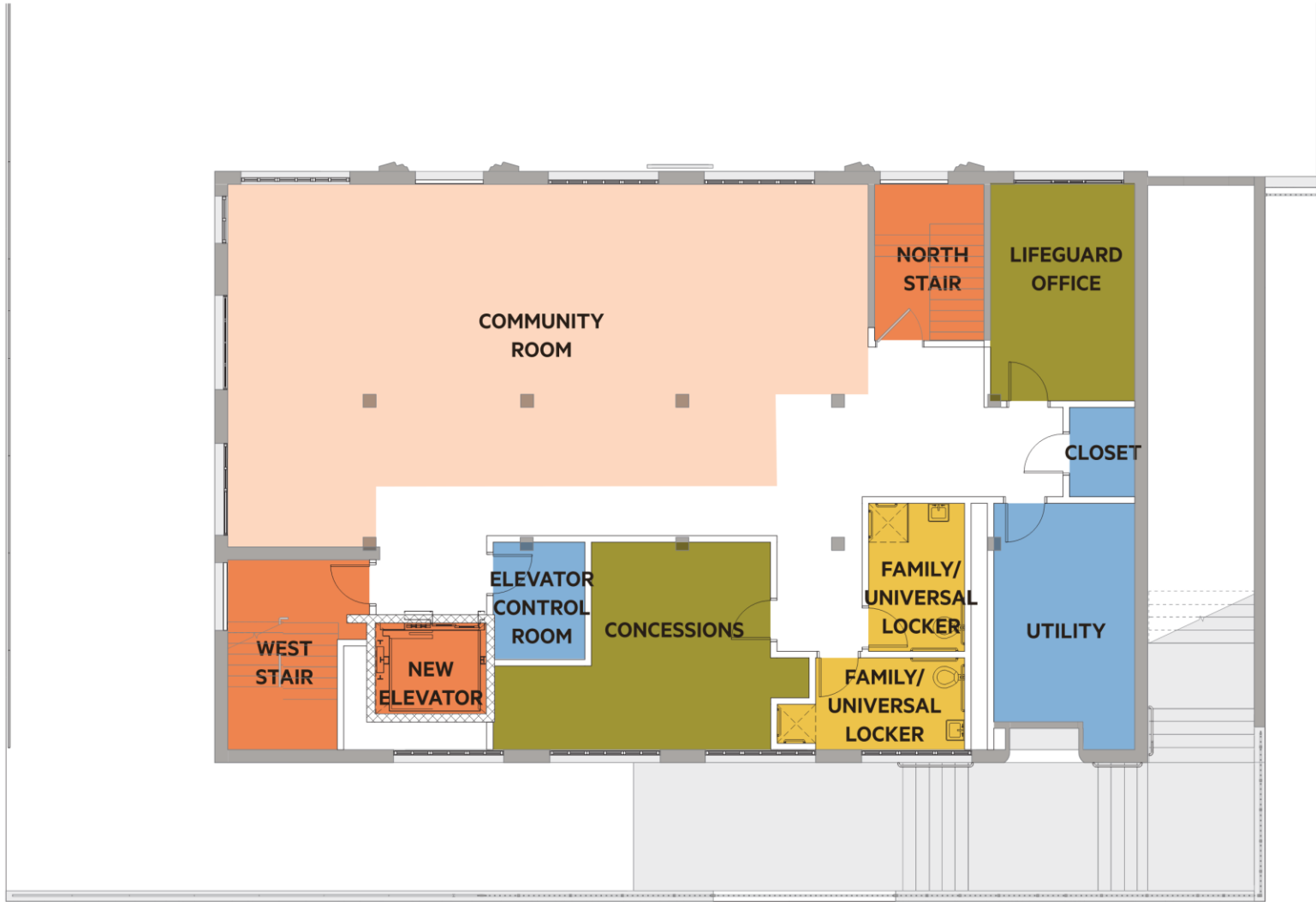

- CIRCULATION
- LOCKER ROOMS
- ADMIN
- UTILITY
- COMMUNITY SPACE

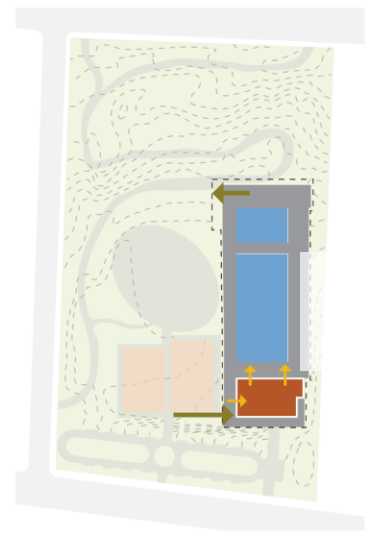

KEY PLAN

Bathhouse-roof terrace

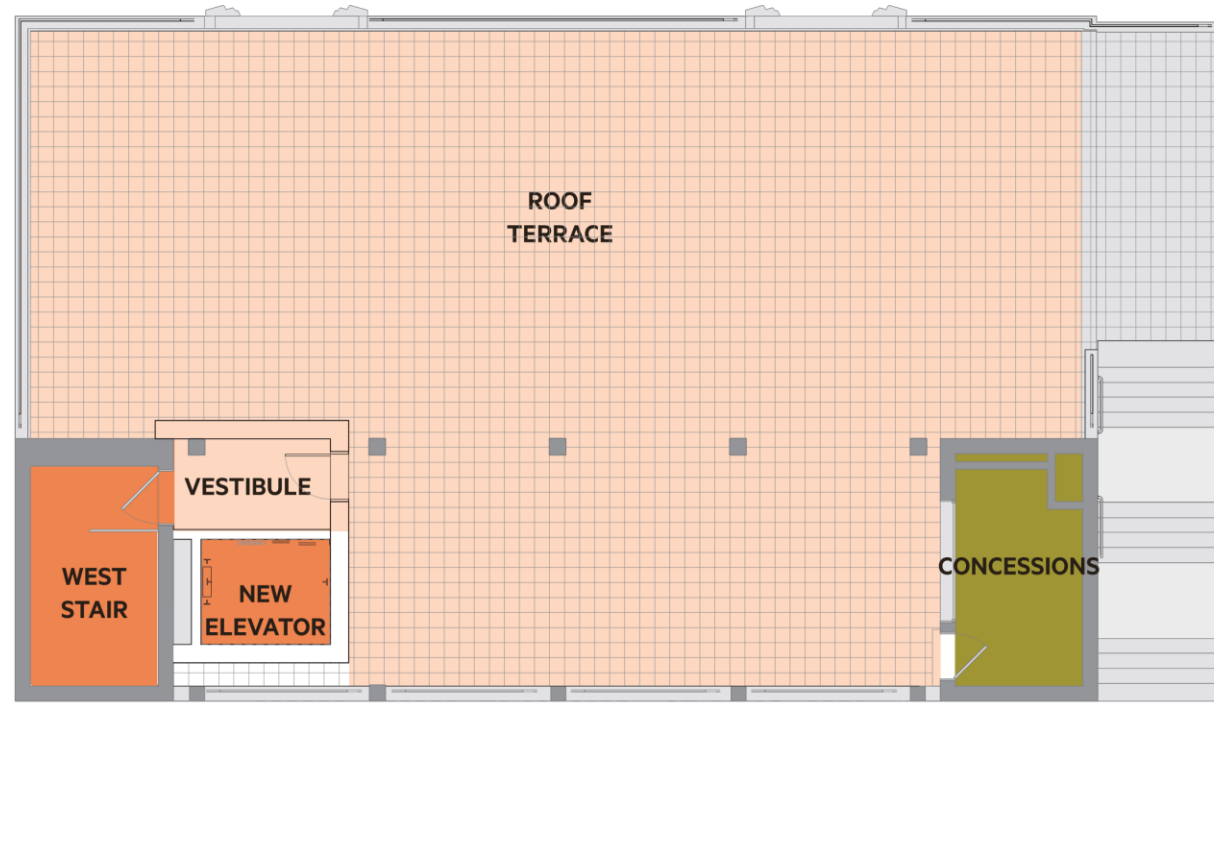

- CIRCULATION
- LOCKER ROOMS
- ADMIN
- UTILITY
- COMMUNITY SPACE

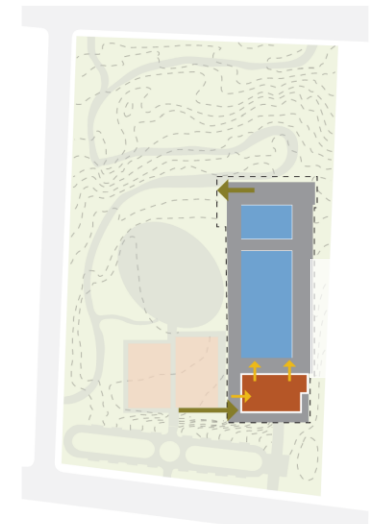

KEY PLAN

Clougherty Pool and Bathhouse



 **Thank you**