



APPLICATION CERTIFICATE of APPROPRIATENESS-or- DESIGN APPROVAL-or-EXEMPTION	For Office Use Only
Deliver or mail to: Environment Department Boston City Hall, Rm 709 Boston, MA 02201	APPLICATION # _____ RECEIVED _____ FEE _____ HEARING DATE _____

DO NOT RETURN THIS FORM BY FAX OR EMAIL

DO NOT STAMP THIS BOX

I. PROPERTY ADDRESS 181 St Botolph Street
NAME of BUSINESS/PROPERTY _____

The names, telephone numbers, postal and e-mail addresses requested below will be used for all subsequent communications relating to this application. Environment Department personnel cannot be responsible for illegible, incomplete or inaccurate contact information provided by applicants.

II. APPLICANT GTI Properties

CONTACT NAME <u>Katherine Cipriani</u>	RELATIONSHIP TO PROPERTY <u>agent</u>
MAILING ADDRESS <u>530 Harrison Avenue Boston, MA</u>	ZIP <u>02118</u>
PHONE <u>617-799-1844</u>	EMAIL <u>kathy@gtiproperties.com</u>

PROPERTY OWNER J & B Associates

CONTACT NAME <u>Katherine Cipriani</u>	
MAILING ADDRESS <u>c/o GTI Properties 530 Harrison Avenue Boston, MA</u>	ZIP <u>02118</u>
PHONE <u>617-799-1844</u>	EMAIL <u>kathy@gtiproperties.com</u>

ARCHITECT N/A

CONTACT NAME _____	
MAILING ADDRESS _____	ZIP _____
PHONE _____	EMAIL _____

CONTRACTOR GTI Properties

CONTACT NAME <u>Katherine Cipriani</u>	
MAILING ADDRESS <u>530 Harrison Avenue Boston, MA</u>	ZIP <u>02118</u>
PHONE <u>617-799-1844</u>	EMAIL <u>kathy@gtiproperties.com</u>

III. DESCRIPTION OF PROPOSED WORK
A BRIEF OUTLINE OF THE PROPOSED WORK MUST BE GIVEN IN THE SPACE PROVIDED BELOW, OR THE APPLICATION WILL NOT BE ACCEPTED. This description provides the basis for the official notice and subsequent decision, and it must clearly represent the entirety of the project. Additional pages may be attached, if necessary, to provide more detailed information.

Scope of Work

Clean all masonry using masonry cleaner and repoint the building. Make any necessary repairs to fire escapes and repaint. Replace existing wood windows on 1,2,3 with double hung 6 over 6 half screen same window and installation detail as 158-174 St. Botolph Street completed in spring 2017. Install new fence on granite curb and stair railing each side of stair as shown on plans submitted. Fence to match previously approved fence for 158-174 St Botolph and 6-12 Blackwood Street.

REQUIRED DOCUMENTATION: Please include all required documentation with this application; review instructions carefully for details.

ESTIMATED COST OF PROPOSED WORK: \$40,000.00

IV. DULY AUTHORIZED SIGNATURES (both required)

The facts set forth above in this application and accompanying documents are a true statement made under penalty of perjury.

APPLICANT Katherine Cignani OWNER* [Signature]

*(If building is a condominium or cooperative, the chairman must sign.)

PRINT Katherine Cignani PRINT MARIO NICOSIA

Environment Department personnel cannot be responsible for verifying the authority of the above individuals to sign this application. Misrepresentation of signatory authority may result in the invalidation of the application.

UNSIGNED OR PARTIALLY SIGNED FORMS WILL BE REJECTED

THIS APPLICATION IS NOT COMPLETE WITHOUT SIGNATURES, FEES AND REQUIRED DOCUMENTATION. The checklist below is for reference only: Please refer to the detailed application instructions for deadlines, fee schedule and required documentation specific to your proposal.

- COMPLETED APPLICATION FORM
- APPLICATION FEE (Check or money order made payable to City of Boston; see fee schedule in Instructions)
- DESCRIPTION OF WORK (A brief description must be included on the front page; additional pages of detailed information may be attached. **Applications that only note "see attached" will not be accepted.**)
- PHOTOS OF EXISTING CONDITIONS
- DRAWINGS AND SPECIFICATIONS AS REQUIRED (See "documentation requirements" in instructions)

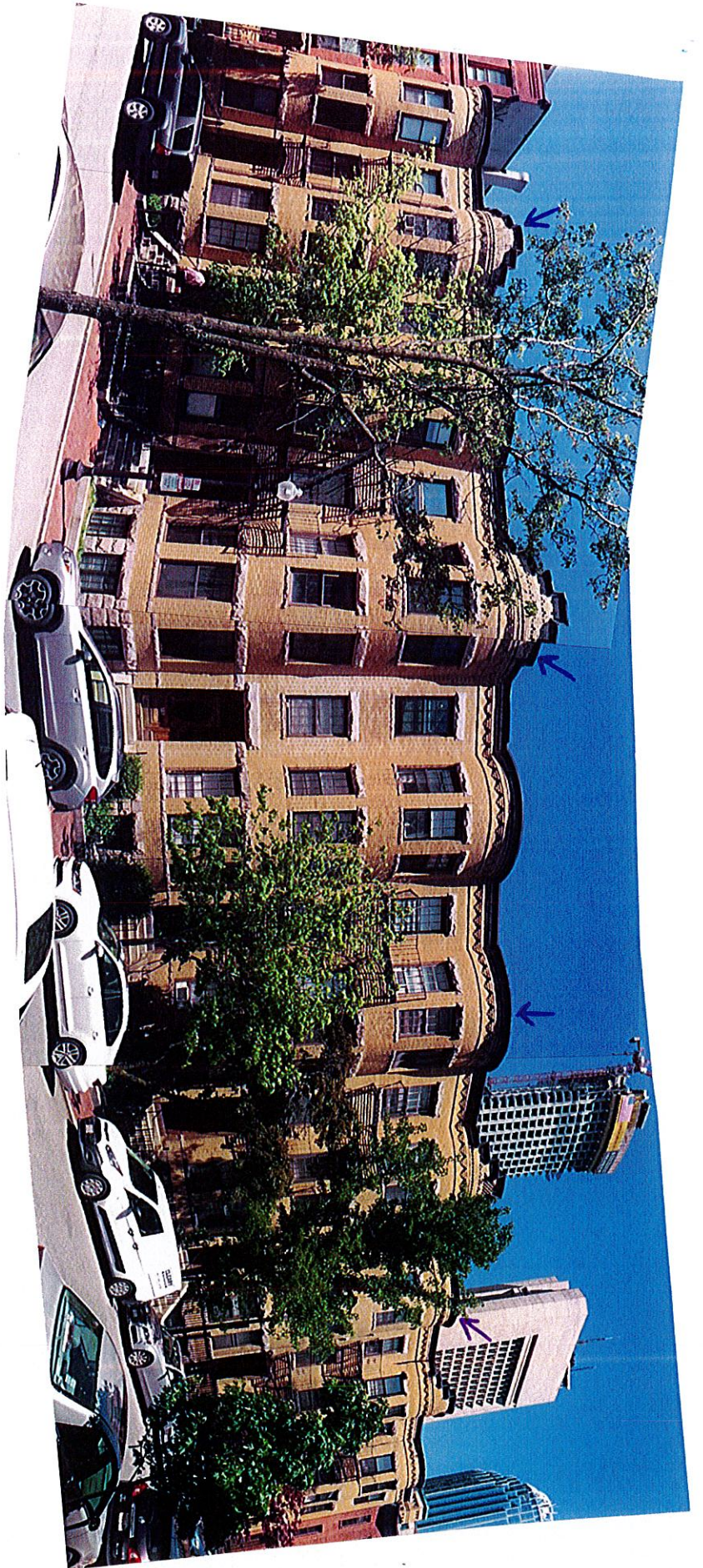

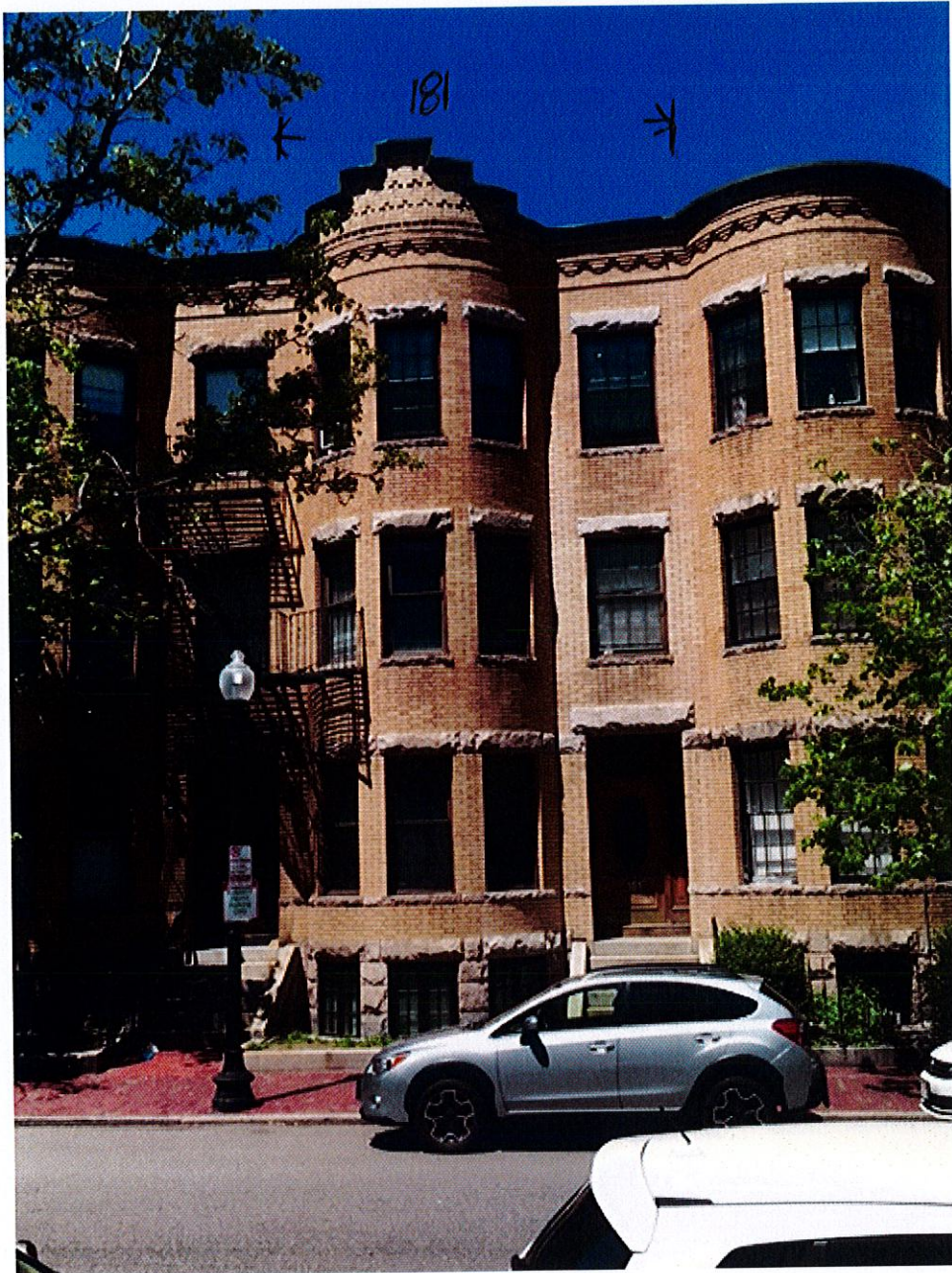

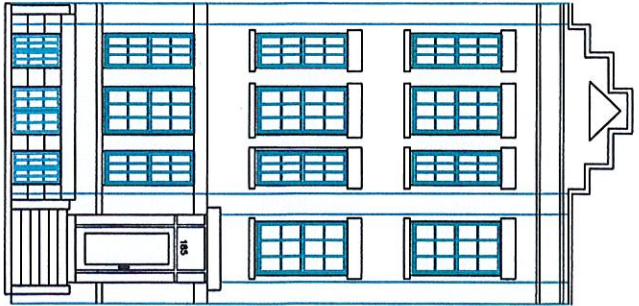

185

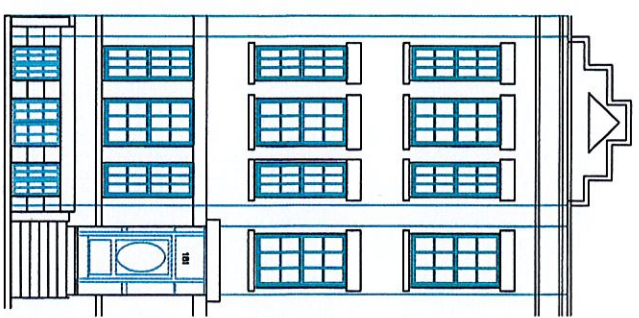
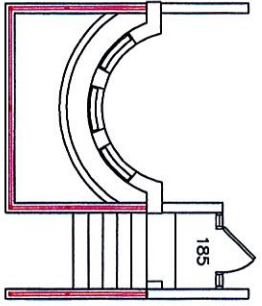

181

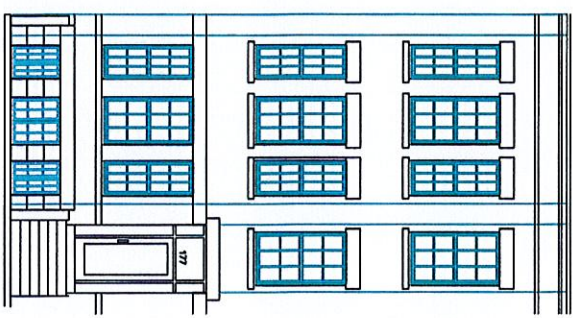
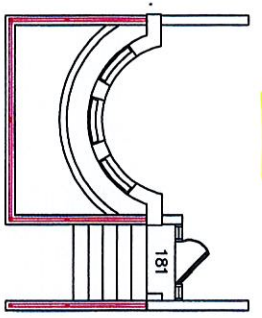

177

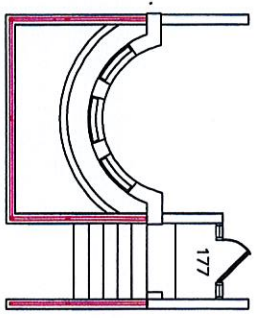

173

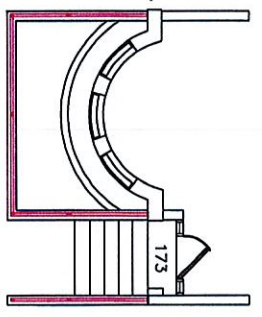

GTI PROPERTIES 530 HARRISON AVENUE BOSTON, MA 02118
PLOTTED AT 1/8"=1'-0" ON 12X18 PAPER DATE: MAY 26, 2018
185, 181, 177, 173 ST BOTOLPH STREET
CLEAN MASONRY, POINT BUILDINGS, REPAIR AND PAINT FIRE ESCAPES
INSTALL NEW FENCE AND STAIR HANDRAILS



181



181

181 EXISTING

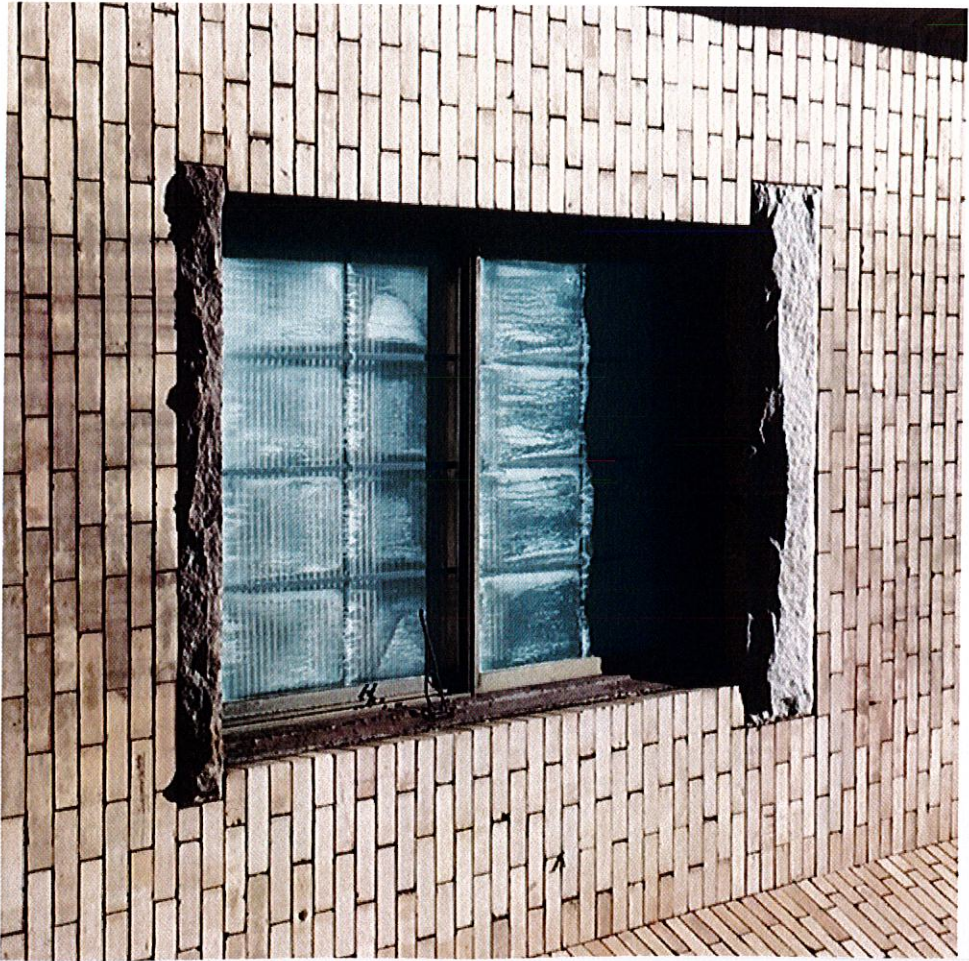

PROPOSED







158, 162, 164, 166, 168, 172 + 174 ST BOSTON
complete window replacement 2016 completed
same window as way 173, 177, 181 + 185 ST BOSTON application

HISTORIC REPLICA WINDOWS

Universal Window and Door has specialized in the development of an impressive line of modified and custom products designed to satisfy the demanding requirements of the Historical Market in applications where the original look of wood windows needs to be maintained. We provide minimal sight lines with the structural strength of aluminum, while offering multiple grid profiles which authentically reproduce the look of wood with old window putty lines. Custom built molds and colors complete an historic restoration.

Such applications incorporate the refurbishment of historic landmark buildings, mills, navy yards, universities, public buildings and brownstone townhouses. Styles include single and double hung, awning (fill-out), casement and fixed window types.

By concentrating on the unique demands of the Historical Market, we have engineered and developed a line that has been approved by the National Park Service, and is being accepted by Historical Societies that exist in virtually every town, including the Boston and New York Landmark Commissions.



**UNIVERSAL WINDOW
AND DOOR, LLC.**



SERIES 400

Double Hung, Rated Heavy Commercial

Thermally Improved Prime Replacement Windows

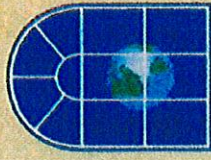
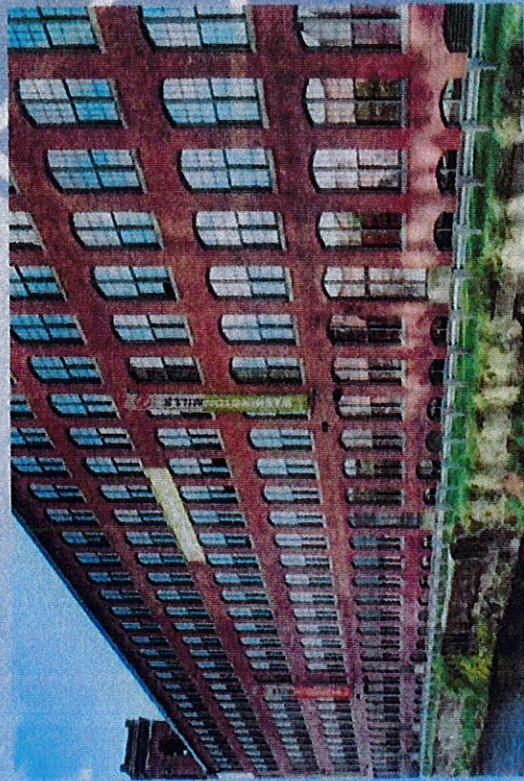

UNIVERSAL
Window and Door

Thermally Improved Prime Replacement Windows Rated Heavy Commercial

DETAILS

Utilizes complete Thermal Break Sash and Master Frame for optimal insulating value

Features 1" clear insulating glass made with Super Spacer™, the world's only TrueWARM® edge technology

Deep double-step Hospital Sill provides superior ventilating and water performance

Mainline Glazing protects glass edge and assures easy repair

Anti-Creep Lock on top sash creates stability for worry-free operation

Telescoping Sash Engineering provides optimum air and water protection

Special Tubular Sash Design gives added strength and long life

Block and Tackle Balances are standard

Customized Hardware assures safe operation (ideal for schools and institutional use)

Performance

DC HC-45 @ 60" x 96"

DH HC-60 @ 48" x 60"

Air Infiltration @ 1.57 psf, 10

Water Resistance @ 11.00 psf, No Entry

Uniform Structural Load

67.5 psf @ 66" x 84"

97.5 psf @ 48" x 72"

Operating Force: 42 lbs MAX

Condensation Resistance Factor: 46

Options

Glass:

Low-E, Soft-Coat, Solar Control, Argon,

Tempered, Obscure, Wire or Spandrel

Balances:

Ultralift, Superlift, Block and Tackle

Wrapping Systems

Exterior Finishing Systems

Interior Trim Systems

Receptor Systems

Flange Frame

Head Expander and Sill Angle

Finishes:

Special finishes, and custom architectural

finishes are available

Child Guard and Vandal Screens

Internal, External, and Interior Grids

Specifications

General: All aluminum windows furnished as shown in the plans shall conform to the specifications in AAMA/NWDA 101/152-97. They are furnished with all necessary hardware, and the hardware items as specified.

Material: Aluminum used in construction shall be 6063-T5, alloy with a minimum tensile strength of 22,000 psi, free of defects, including porosity, and with standard wall thicknesses as defined in the Architectural Aluminum Manufacturer's Association Material Specifications for aluminum windows. All members of the frame and sash shall be spilt and bridged with a continuous structural thermal break of high density, low conductivity urethane insulation cavity fill, with removal of the extrusion cavity bridging aluminum after curing.

Construction and Operation: Windows are assembled to perform as herein specified, to assure a neat appearance and weather tight construction. All sash and frame members are firmly joined with mechanical joints using stainless steel screws into integral screw ports. Each frame corner joint is secured with two screws. Sash corner joints are telescoped for rigidity and appearance. Meeting rails have mechanical interlocks, and the horizontal rails of the upper and lower sashes have extruded handles for operating the sashes. When windows are not being expressly used for ventilation, they must be fully closed and locked. Failure to do so may result in personal injury or damage to property. All sashes are tilt type for easy cleaning. Top sashes have "Anti-Creep" latches. Glazing: Sashes are glazed with 1" sealed insulated glass, using "Float Glass" quality, and constructed to allow field replacement of glazing material. Glazing is "Marine" type wrap around vinyl gasket, without the use of removable beads or glazing compound. All insulated glass conforms to, and is in compliance with, ASTM E 773-83 AN E 744-74A, Class CBA.

Spacer: Edgetech's SuperSpacer™ contains NO-Metal and is one of the most thermally efficient IG spacers available today. SuperSpacer™ reduces sealant stress while improving heat flow resistance, glass surface temperature, condensation resistance and sound absorption. SuperSpacer™ is the only polymer foam, NO-Metal warm edge spacer.

Finish: The exposed surfaces of all aluminum members shall be clean and free of serious blemishes, scratches or tool marks. Standard finish is electrostatically applied acrylic enamel with a 5-stage chromate under-coating conforming to AAMA 603.8 standard. Standard colors are white, black, bronze, green and beige (see color chart). Other architect specified finishes may be available at additional cost.

Hardware: All fasteners, screws and other miscellaneous fastening devices shall be of non-corrosive material compatible with aluminum. Balances of appropriate size and capacity to hold each sash stationary at open position are factory installed. They meet AAMA 902.2 specification, and are easily replaceable after the window is installed. Block and Tackle Balances are standard. Intra-Lift and Spiral balances are available at an additional cost.





UNIVERSAL WINDOW
 PRODUCTS, LLC
 311 MADISON ST.
 MILWAUKEE, WI 53203
 (414) 224-2200
 WWW.UNIVERSALWINDOW.COM

DRAWING TITLE
**#400
 Historic
 Replica**

REVISIONS
 # SUBJECT DATE

DATE OF ISSUE
 PROJECT NO.
 DRAWING NO.
 SCALE
 SHEET NO.
 TOTAL SHEETS

400

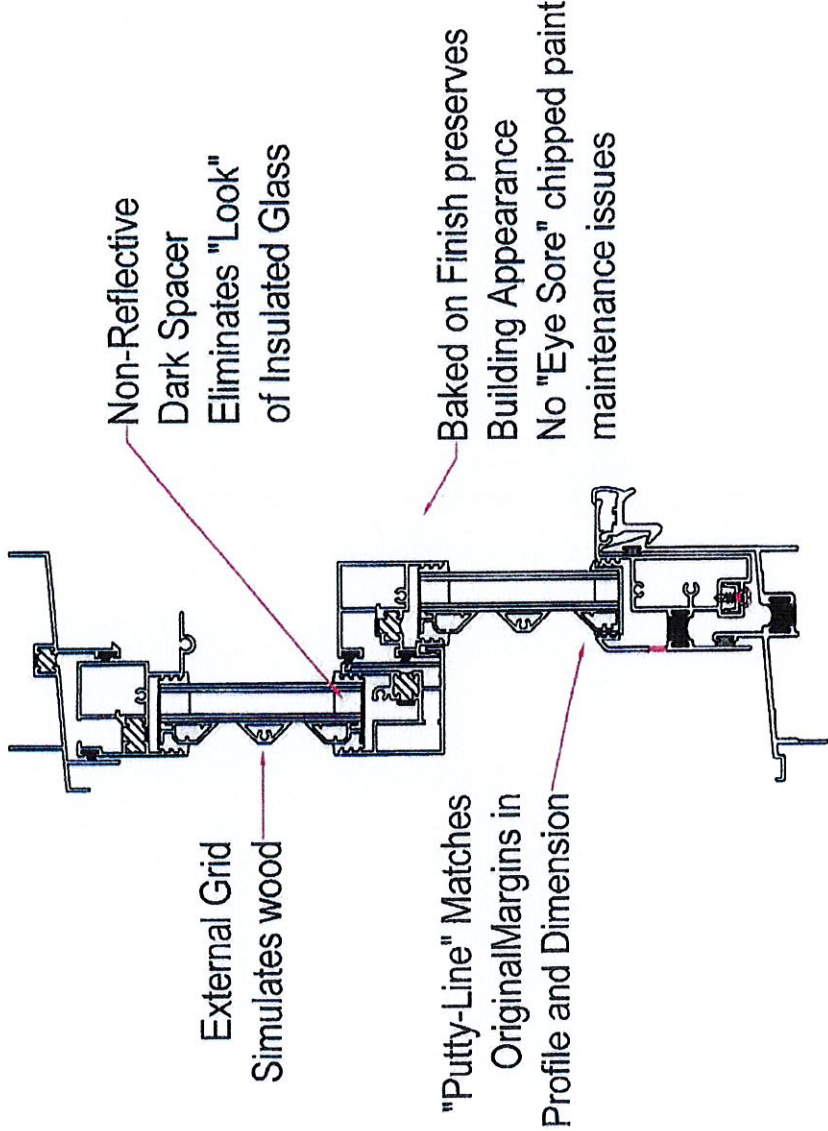

MUNTIN (GRID) PROFILES

Shown smaller than actual size

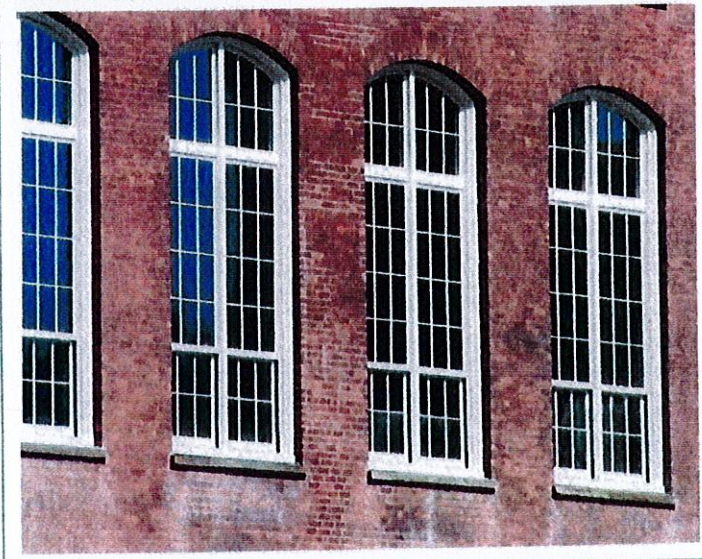
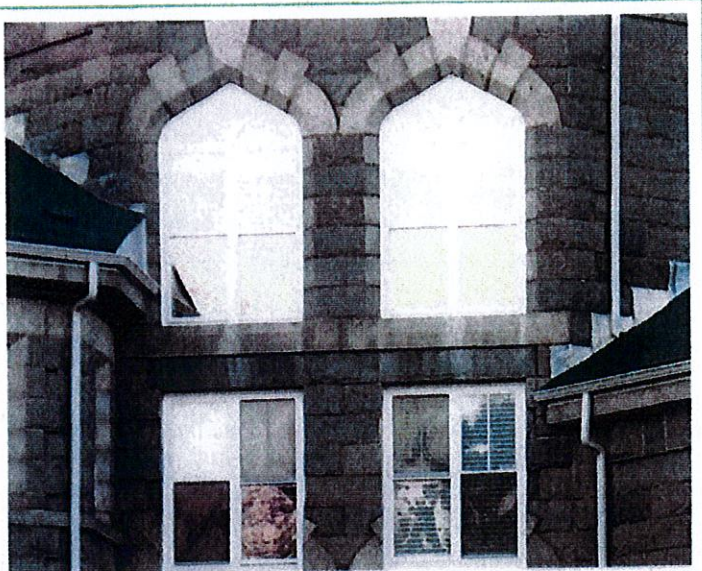
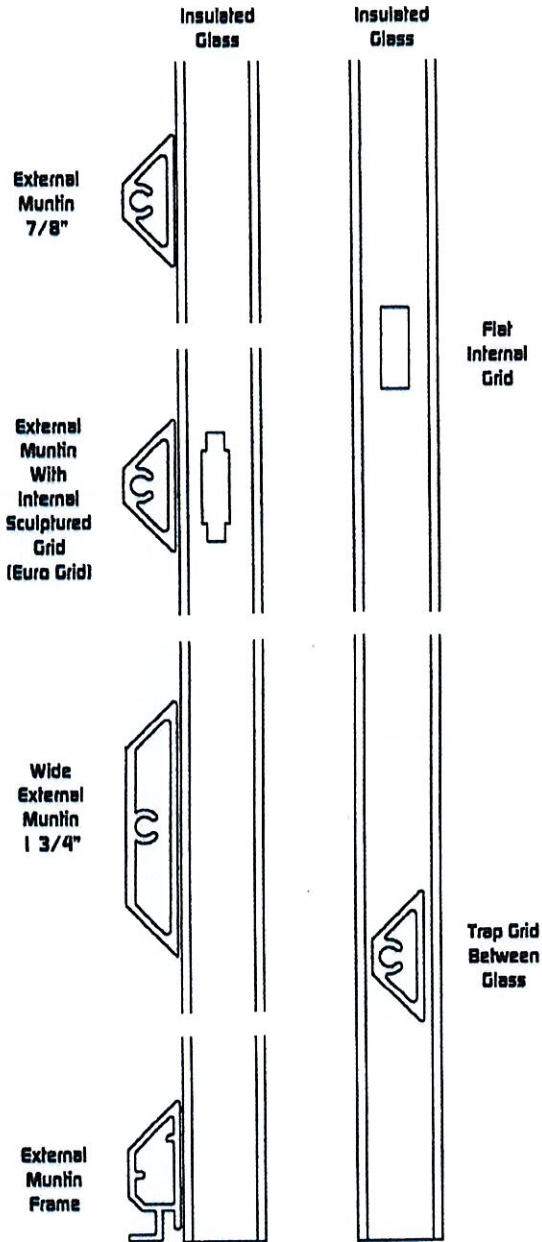

UNIVERSAL WINDOW AND DOOR, LLC.

303 Mechanic Street,
Marlborough, MA 01752
800-633-0108 508-481-2850
www.universalwindow.com

UNIVERSAL WINDOW & DOOR INTERNAL AND EXTERNAL GRIDS

Universal Internal and External Grids and Muntins are specially designed to coordinate with all Universal double-hung, single-hung, projected, and fixed window series. Universal grids are custom-manufactured to meet your specifications for historic, architectural, and aesthetic requirements. Universal grids are compatible with many manufacturers of store-fronts and curtain walls.

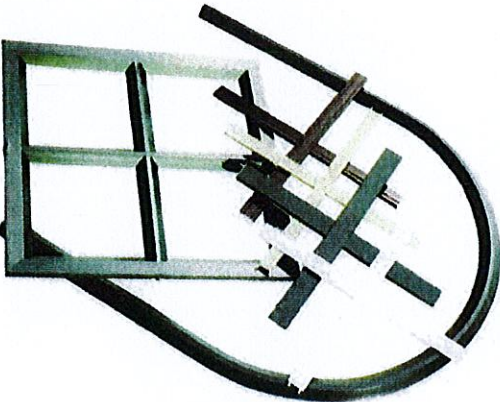

**UNIVERSAL WINDOW
AND DOOR, LLC.**



Division 8 Doors and Windows

SECTION 08520 ALUMINUM WINDOWS

Part 1 – GENERAL

1.1 REFERENCES

- A. The general conditions, supplementary conditions and applicable portions of division 1 of the specifications are a part of this section, which shall consist of all labor, equipment and materials necessary to complete all quality control work indicated on the drawings, herein specified or both.
- B. The following minimum provisions standards and tolerances shall apply to all work under this contract. Where stricter standards and tolerances are specified, they shall take precedence over these standards and tolerances. Owner reserves the right to define intent of specifications.
- C. Manufacturer will have been producing the model window used for this project for similar projects for a minimum of five years.
- D. It will be the bidder responsibility to verify all quantities and type of windows.

1.2 SCOPE

- A. The work of this section consists of supply and installation of aluminum windows and related items, as indicated on the drawings and specified herein. Such work includes but is not limited to the following:
 - 1. Double hung windows, double-glazing, thermally broken with tilt-in sash and factory standard balances. Side load will not be acceptable.
 - 2. Screens: Exterior half screens. Finish to match windows. With fiberglass mesh.
 - 3. Factory glazing:
 - 4. Sealant within window system
 - 5. Hardware, accessories and appurtenances.

1.3 SUBMITTALS

- A. Shop drawings showing installation conditions throughout and catalog cuts shall be submitted for approval. Shop drawings shall include elevations of all windows (minimum scale ½ inch equals 1 foot), and full size details of every conditions indicating thickness of aluminum, fastenings, the size and spacing of anchor, method of glazing, details of operations hardware, method and materials for weatherstripping, and method of attaching screens.
- B. Submit color chips for selection by architect from manufacturer's standard.
- C. One complete full-size sample window of type proposed for use shall be submitted for approval. Sample shall be complete with hardware, glazing, weatherstripping, anchors, screen and other accessories, and shall be furnished as specified by the architect.

Division 8 Doors and Windows

PART 2 – PRODUCTS

2.1 MANUFACTURER

- A. The windows and doors of this section shall be of a type herein specified by Universal Window and Door LLC.
- B. Similar to Universal DH CW45 – Model # 400 sizes according to the window schedule.

2.2 GENERAL REQUIREMENTS

- A. All windows shall be of the thermally broken type, including sash and frame members.
- B. **MATERIALS:** Aluminum shall be of commercial quality aluminum alloy 6063 T5 free from defects impairing strength durability. All window members shall be of extruded aluminum and shall have a guaranteed minimum ultimate tensile strength of 22,000 PSI, and a yield of 16,000 PSI. Secondary members such as self-alignment clips, weatherstripping, guides, etc. shall be made of a suitable and compatible material.
- C. **HARDWARE:** Double hung units shall be equipped with an integral lift handle on bottom sash; top of upper sash to have a continuous integral pull down handle. Both upper and lower sash shall be counter balanced so that they remain open in any position. Balances shall be heavy-duty factory standard type as customary with the manufacturer and suitable for installation required. Balances shall conform to AAMA 902.2.
- D. **FINISH:** Standard finish shall be factory-applied thermo setting acrylic enamel. Color selected by architect from manufacturer's standard. Finish to conform to AAMA 603.8 standard. Optional AAMA 604 and AAMA 605 finishes are available.
- E. **GLAZING:** Both sashes shall be channel glazed using 5/8" thick double insulated glass with a flexible "marine" type vinyl-glazing channel. The overall glass thickness of 5/8" with an air space measured 3/8" consisting of 1/8" RLE soft coat Low-E / Argon gas / 1/8" clear annealed separated with Edgetech "warm edge" super spacer.
- F. Simulated Divided Lite Muntins are to be of External applied trapezoid type and between glass type-configurations shown on drawings.
- G. Both sashes are able to be removable after tilting without the use of special tools.
- H. Top sash to be held by "anti-creep" latch.

PERFORMANCE CRITERIA

All double hung to conform to the following criteria:

1. Air infiltration: Not to exceed .03 cfm/ft @ 25 mph. ASTM E283
2. Water resistance: There shall be no leakage as defined in the high performance test method with a test pressure of 7.52 PSF. ASTM E547 & E331
3. Uniform Load Deflection Test: Under an exterior uniform load of 45 PSF no member in the completely assembled window shall deflect more than 1/175 of its span. Test shall be conducted in accordance of ASTM E330.
4. Uniform Load Structural Test: The window shall be subjected separately to an exterior uniform load of 67.5 PSF and an interior uniform load of 67.5 PSF. Tests shall be conducted in accordance with ASTM E330
5. NFRC *u*-value of .42

Division 8 Doors and Windows

PART 3 – EXECUTION

3.1 INSTALLATION

- A. Work Included: Provide labor, materials and equipment necessary to complete the work of the Replacement Window Contract, and with out limiting the generality thereof include:
1. Windows to be installed plumb, square, and level with proper shimming and blocking to support window in opening.
 2. Windows to be installed in strict accordance with approved shop drawings.

3.2 CLEANING

- A. Clean interior and exterior surfaces of window units of mortar, plaster, paint spattering spots, and other foreign matter to present a neat appearance and to prevent fouling of weathering surfaces and weatherstripping, and to prevent interference with the operation of hardware.

3.3 PRODUCT HANDLING

- A. All materials shall be delivered, stored, handled, and installed so as not to be damaged or deformed.

3.4 GUARANTEES AND TEST DATA

- A. Provide manufacturer's guarantees and independent test results indication compliance with AAMA specifications and performance criteria. Manufacturer's standard guarantee shall be for a minimum of one year.
- B. Insulated glass units shall be provided with a five-year warranty unless otherwise approved by the architect.

3.5 COORDINATION

- A. Coordinate work with that of all other trades affecting or affected by work of this section. Cooperate with such trades to assure the steady progress of all work under the contract.



1 1/2" CLAD WINDOW
HEADER

1/8" CONSISTS OF
1/2" FRAME x 2 w/ 1/8-1/4" MULLION

SURFACE MOUNTED
PERMANENT 7/8"
BOTH SIDES OF
GLASS

NOTE: NO BECK
MOLD

45 1/2"

7/8"

1/8"
MULLION

2"
SASH FRAME
TYPICAL
1/2" WINDOW FRAME
ALL AROUND
SASH

1/2" CAULK JOINT

1 1/2" CLAD SILL

58 1/2"

ST BOTOLPH ST
SCALE 1 1/2" = 1'-0"

FELD WEN SITELINE CLAD WINDOW

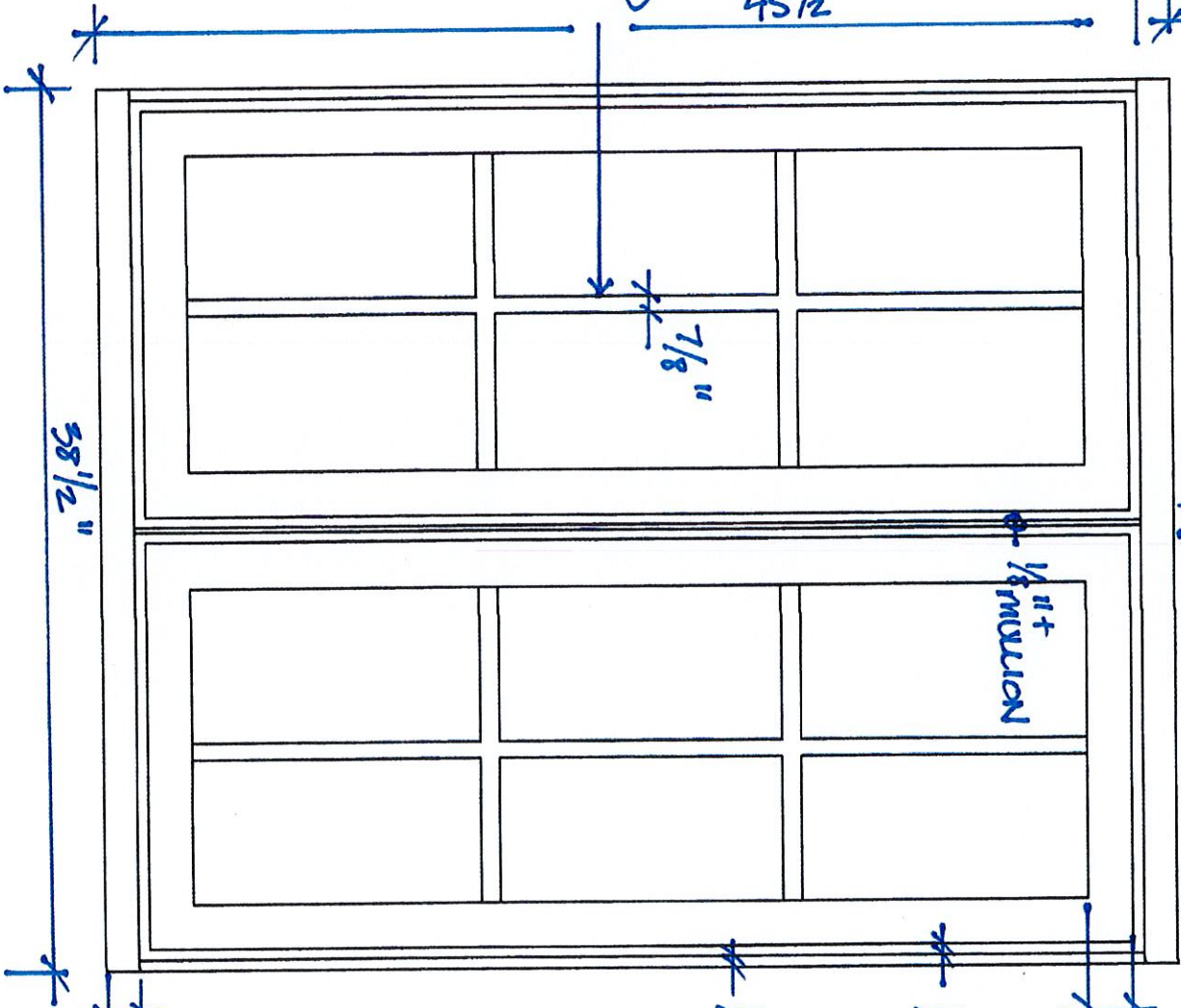

LITE CUT INFORMATION

Siteline clad casement windows are available with removable grilles in 7/8", 1-1/8" and 1-3/8" widths, Airspace (between the panes) grilles, and Simulated Divided Lites. Standard lite cuts are rectangular, and conform to the layouts noted in the charts on the next page. To use the chart, refer to the appropriate table by the type of window and type of bars or grilles the section drawings illustrate. Then simply cross reference the frame Height and Width to determine the standard lite cut.

LITE CUT OPTIONS

Special lite cut patterns can include a wide variety of straight line and radius patterns. The illustrations shown here represent just a few of the possibilities. Rectangular, horizontal, vertical and Prairie lite patterns are available in all standard size clad casement windows. Uneven, diamond, radius and Gothic lite cuts are available, subject to approval. Approvals are based on the ability to fulfill the design requirement while maintaining the construction integrity of the finished product.

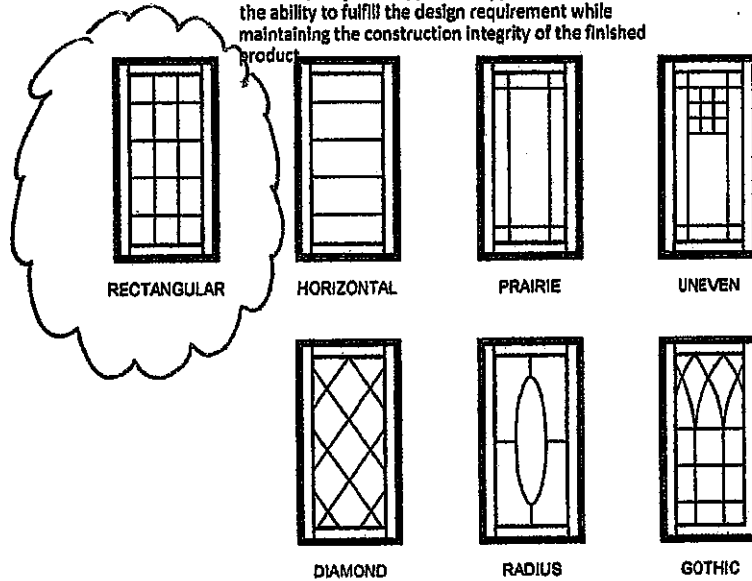

BAR ALIGNMENT

Alignment of divided lite muntin bars from one window to the next is often required by fine architectural design. Wood grilles, Grilles Between the Glass, grilles, and Simulated Divided Lites may be specified with muntin bars aligned.

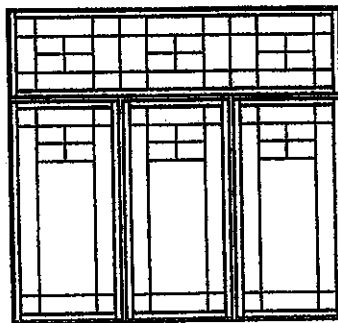

**HORIZONTAL SECTION
OPERATOR**

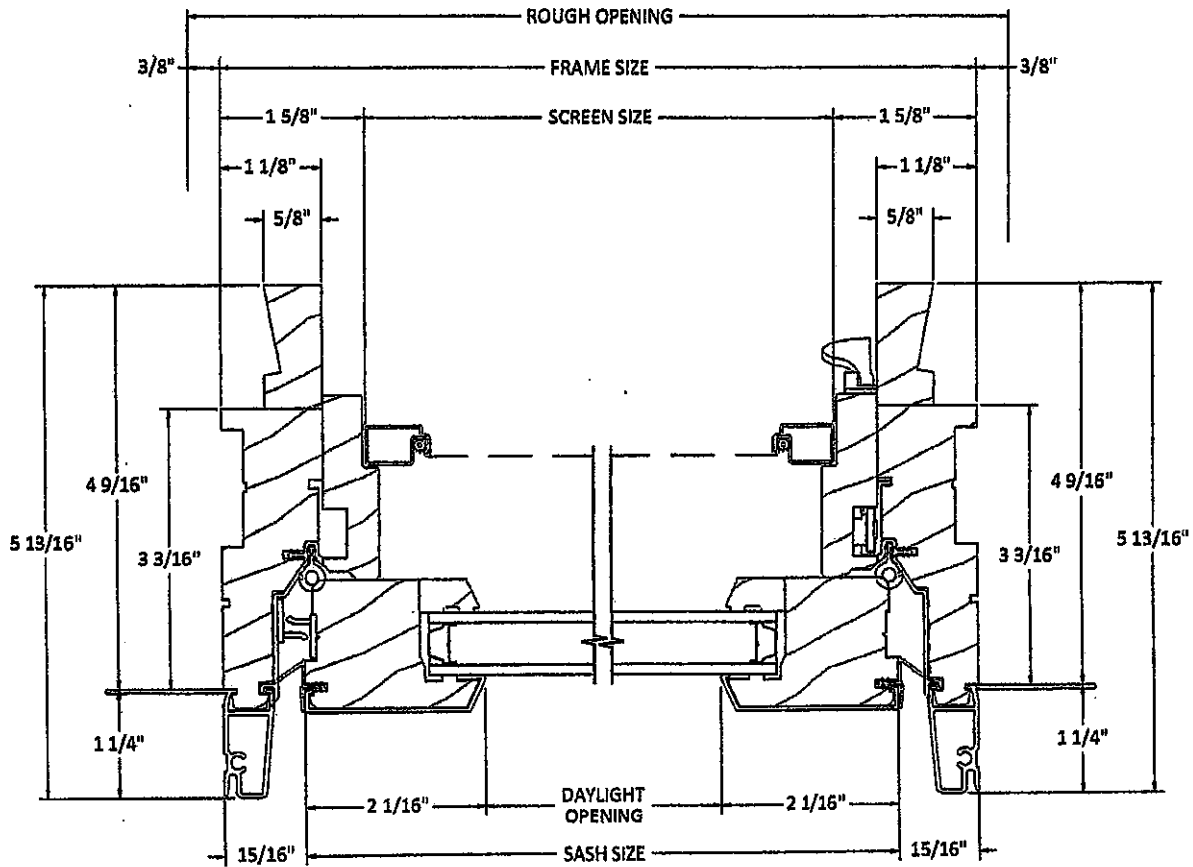

**SITELINE CLAD WINDOW
SITELINE CASEMENT**

**VERTICAL SECTION
OPERATOR**

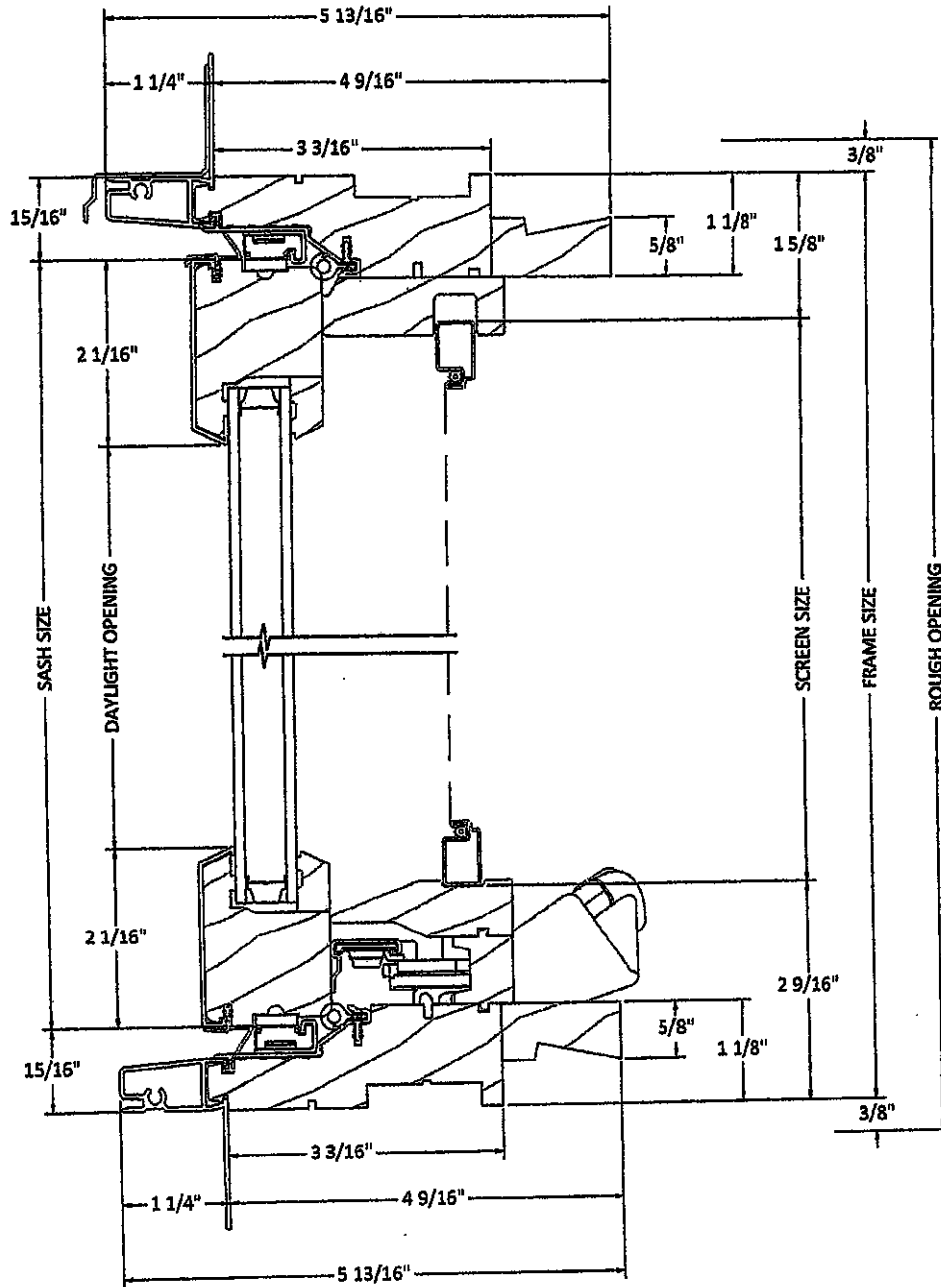

DIVIDED LITE OPTIONS

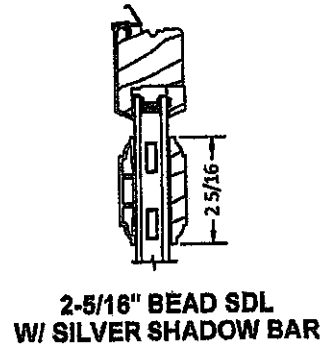
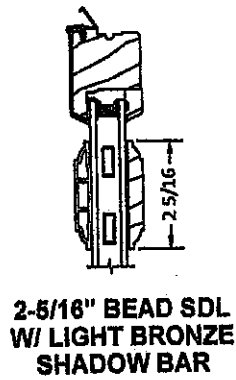
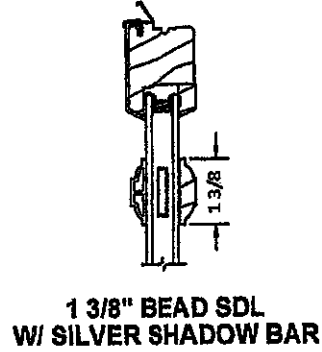
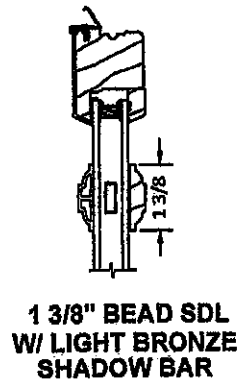
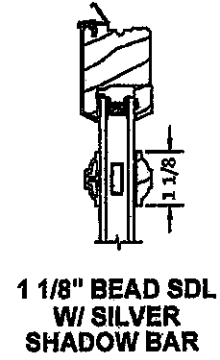
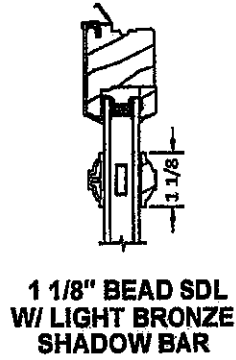
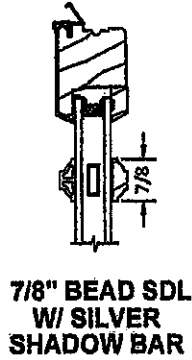
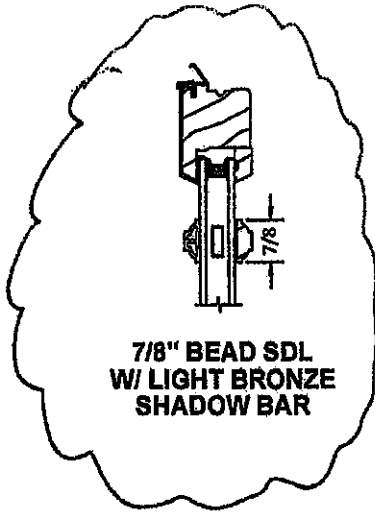

181 ST BOTOLPH



ATTACH RAIL
HERE
BRICK IS
APPROX. 35"
JFF
TREAD

POST LOCATIONS
IF
PREFERRED
BOTH SIDES

ATTACH RAIL ON BRICK
OR POST, NO PREFERENCE.

3 POST LOCATIONS ON FRONT GRANITE CURB
1 POST EACH ON SIDE CURBS.









SIMPLE PAUL REPOSED

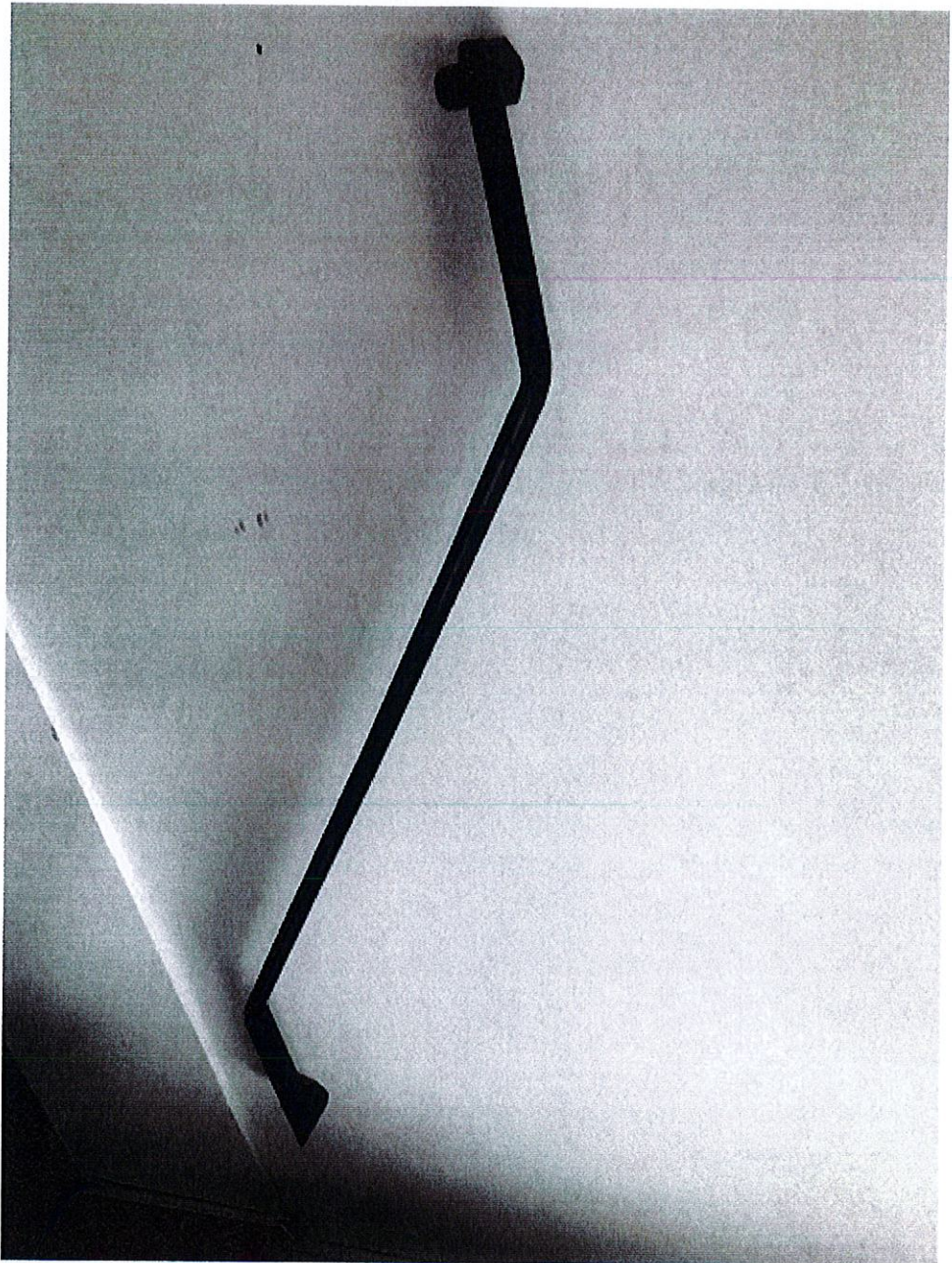



CITY OF BOSTON THE ENVIRONMENT DEPARTMENT

Boston City Hall, Room 805 • Boston, MA 02201 • 617/635-3850 • FAX: 617/635-3435

June 14, 2004

ST. BOTOLPH AREA ARCHITECTURAL CONSERVATION DISTRICT COMMISSION

Katherine Cipriani
c/o GTI Properties
560 Harrison Avenue
Boston, MA 02118

NOTICE OF DECISION

Application 04.057SB

6-12 BLACKWOOD STREET, 158, 162, 164, 166, 168, 172, 174, 177, 185 ST. BOTOLPH STREET

CERTIFICATE OF DESIGN APPROVAL

Dear Ms. Cipriani:

At a public hearing held in Boston City Hall on May 18, 2004, the St. Botolph Area Architectural Conservation District Commission reviewed your application to replace the front yard fences at the above-listed properties and remove brick paving from the front yard at 185 St. Botolph Street. The new black painted steel fences are 33 ½" high and posts are 39" high, not including the height of the existing granite curbs.

The commission voted to approve your application as presented and with the conditions noted. Posts will occur at regular intervals, approximately every 7-8 feet at the larger yards. One additional post shall be added to the Blackwood Street elevation of 158 St. Botolph Street to make it consistent with the St. Botolph Street section of fence.

This determination is based solely upon the information submitted to the staff with the application. If statutory reviews by other authorities conflict with this decision, those actions may affect the status of this certificate. The applicant is required to notify the Commission of any changes to this proposal, and failure to do so may affect the status of this certificate. The commission reserves the right to require remedial action to bring work into compliance with commission standards if any work occurring without a certificate of design approval results in significant change in the appearance of the building or if work does not meet the noted specifications of a certificate of design approval. This certificate is valid for two years from the date of issue. Please bring a copy of this certificate with you when filing for permits from the Inspectional Services Department. Photographs of the completed project should be submitted to this office to confirm compliance with the terms of this certificate.

If you have any questions regarding appropriate compliance with this decision, please contact staff at (617) 635-3850. Thank you for your cooperation with the commission.

Sincerely,

Alexa Pinard
Preservation Planner