

BLUEBIKES IN FRANKLIN PARK

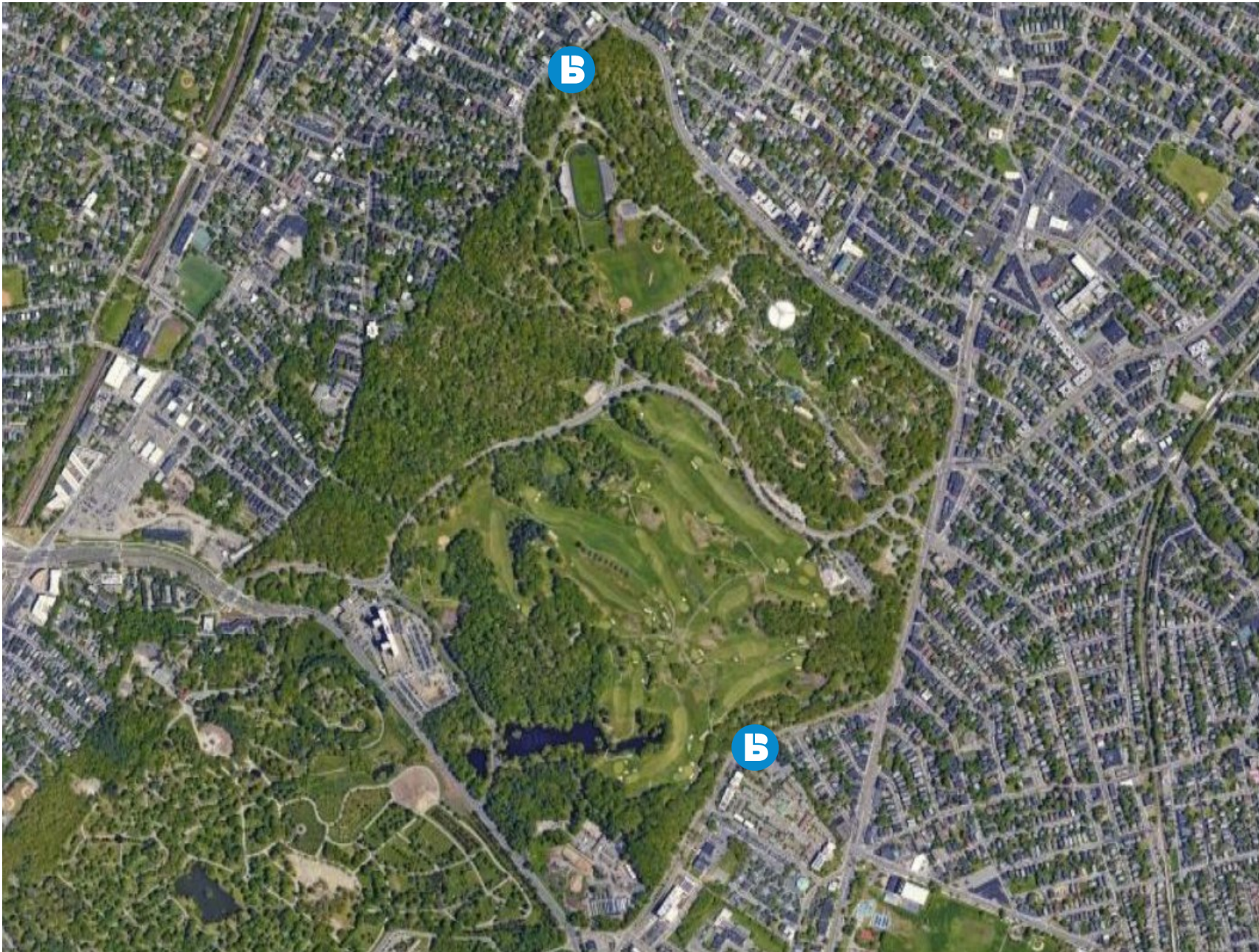

SUPPORTING FRANKLIN PARK ACTION PLAN

Park Circulation

Primary Loops for Bikes & Pedestrians

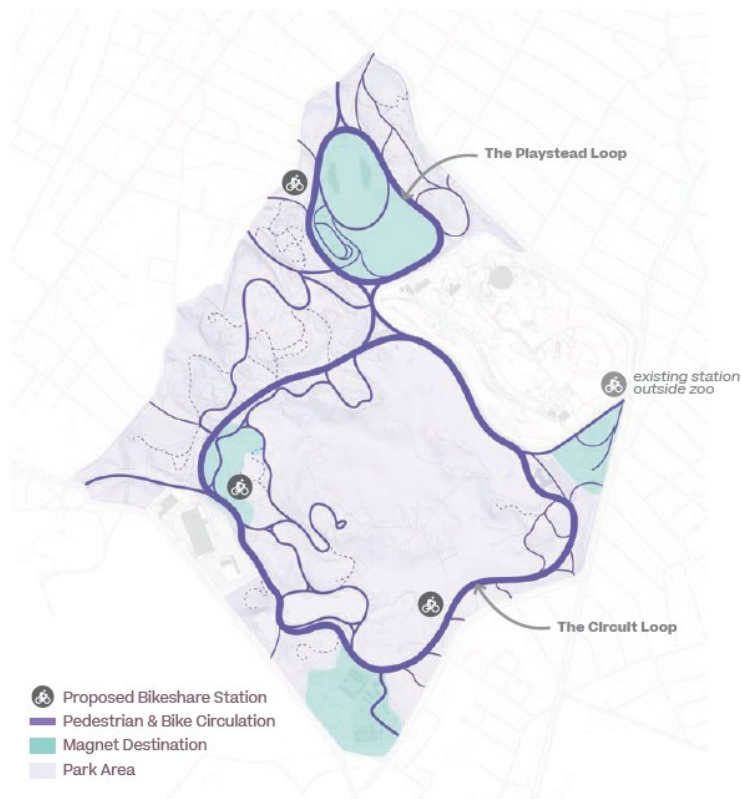

Connect magnet destinations with pedestrian and bike loops that support all abilities



City of Boston
Mayor Martin J. Walsh



STATION COMPONENTS

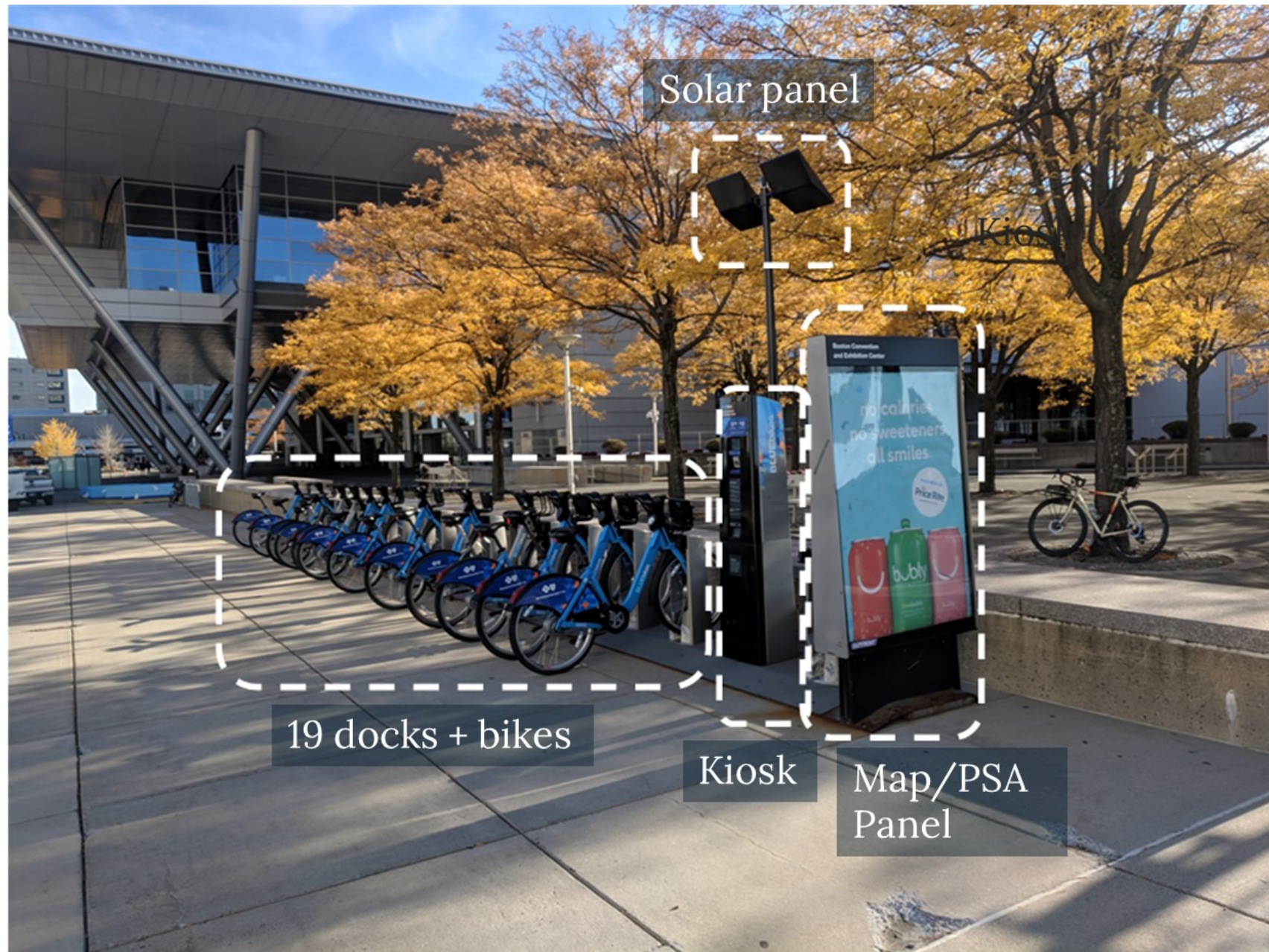

STANDARD STATION CONFIGURATION

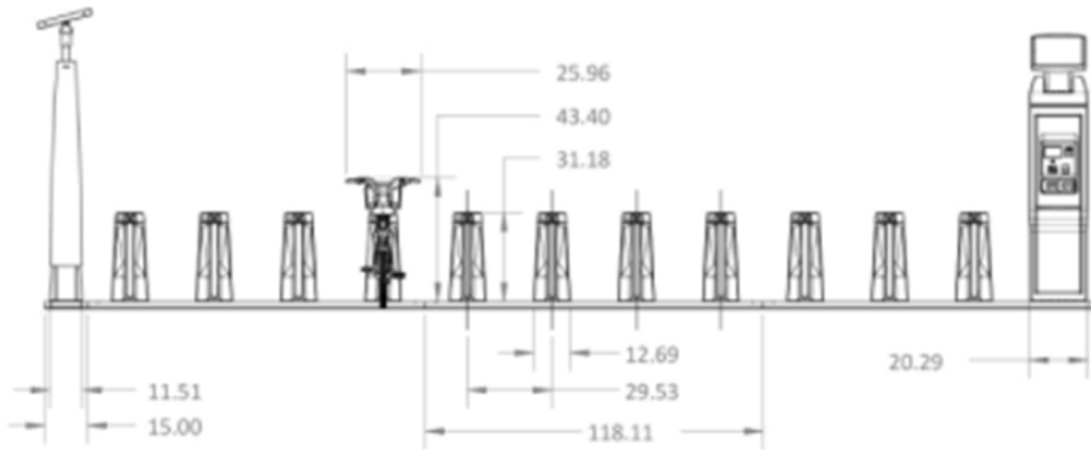
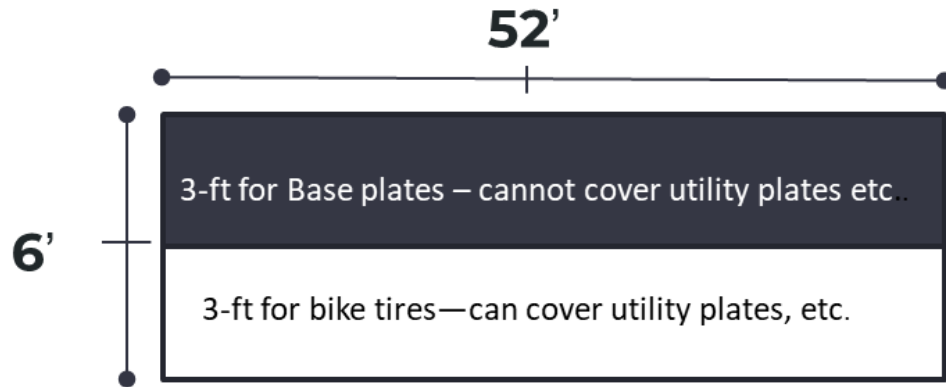

85 AMERICAN LEGION HIGHWAY

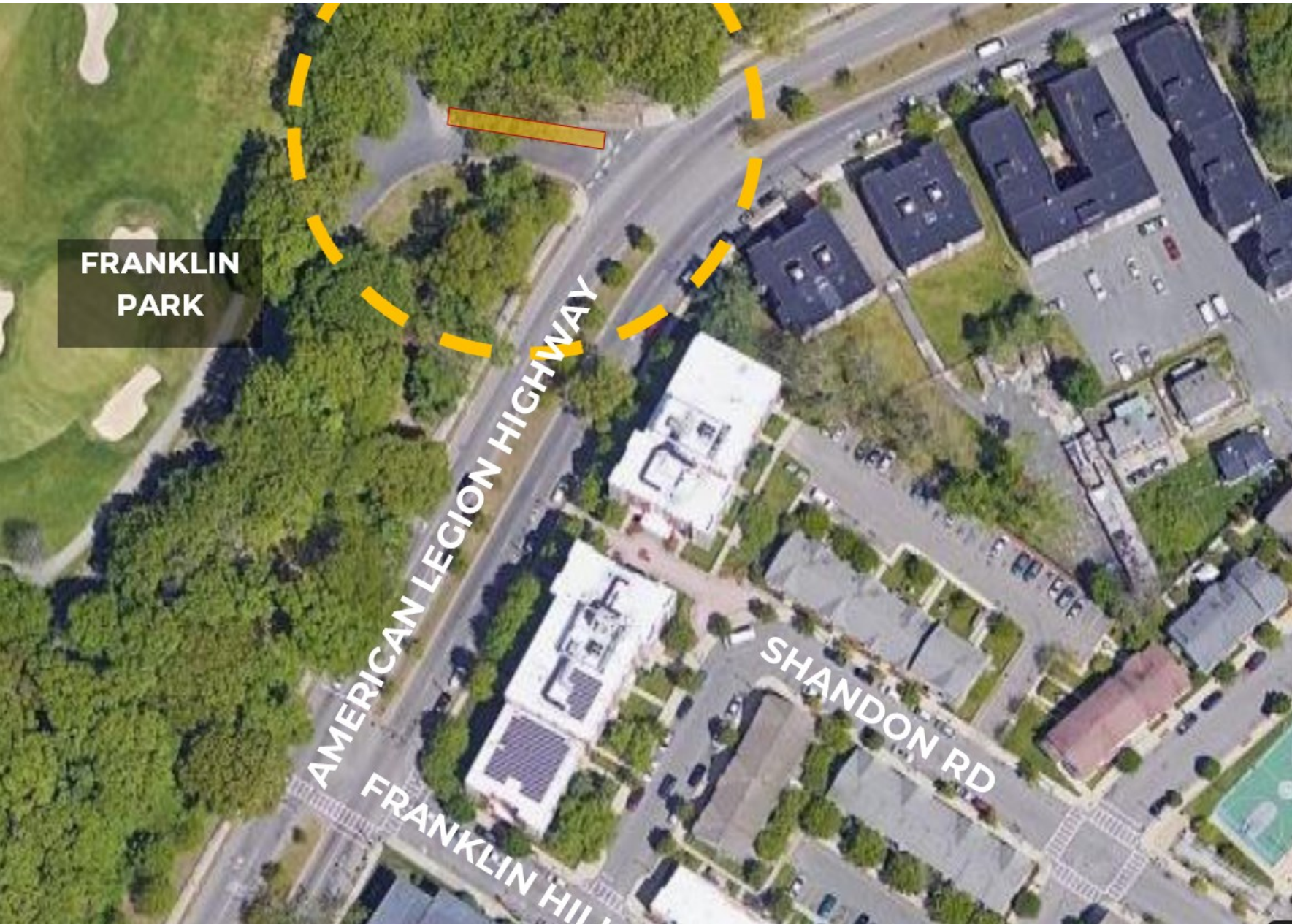

85 AMERICAN LEGION HIGHWAY

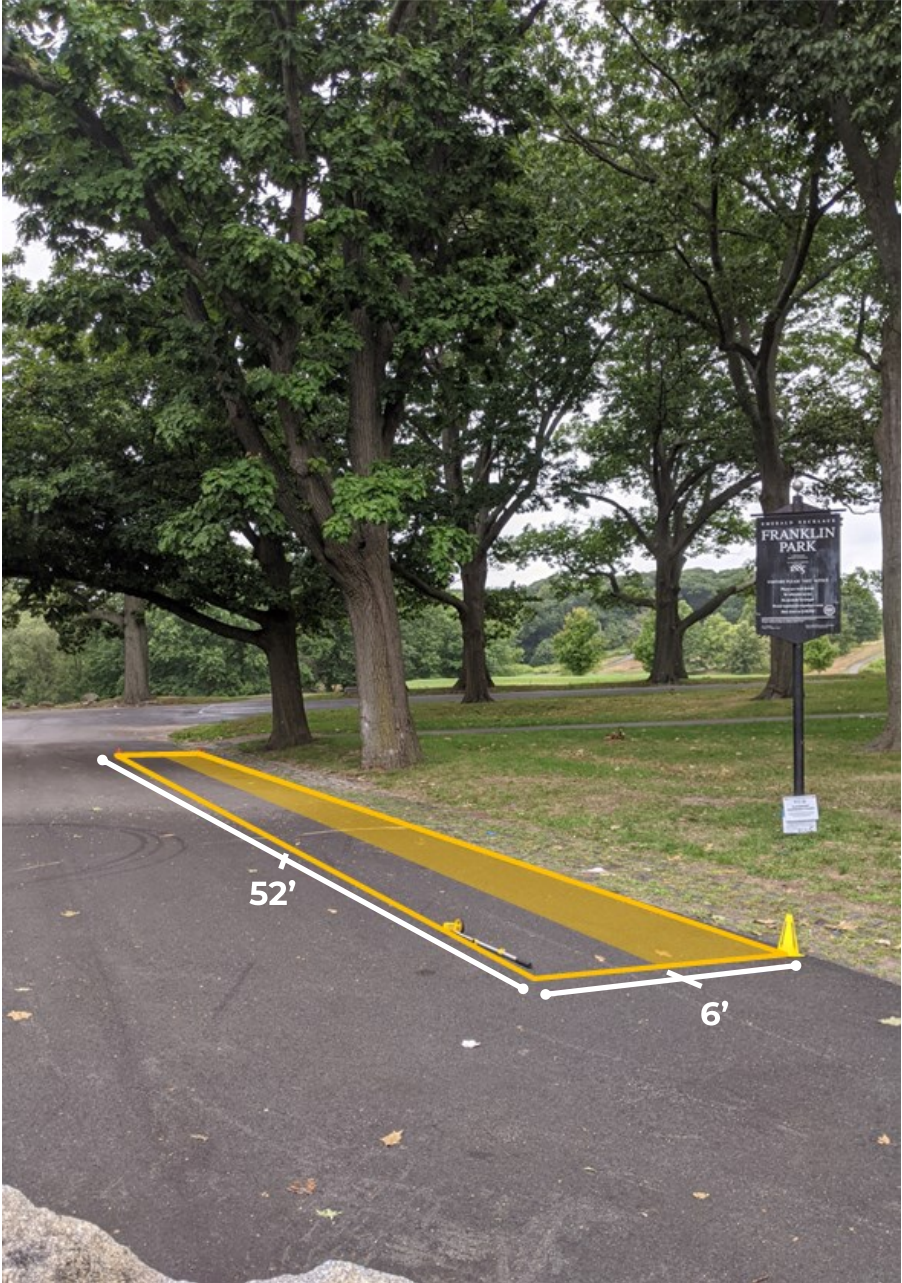

WALNUT AVE AT SCHOOL ST



WALNUT AVE AT SCHOOL ST

