

**E-SERIES**  
Architectural Collection

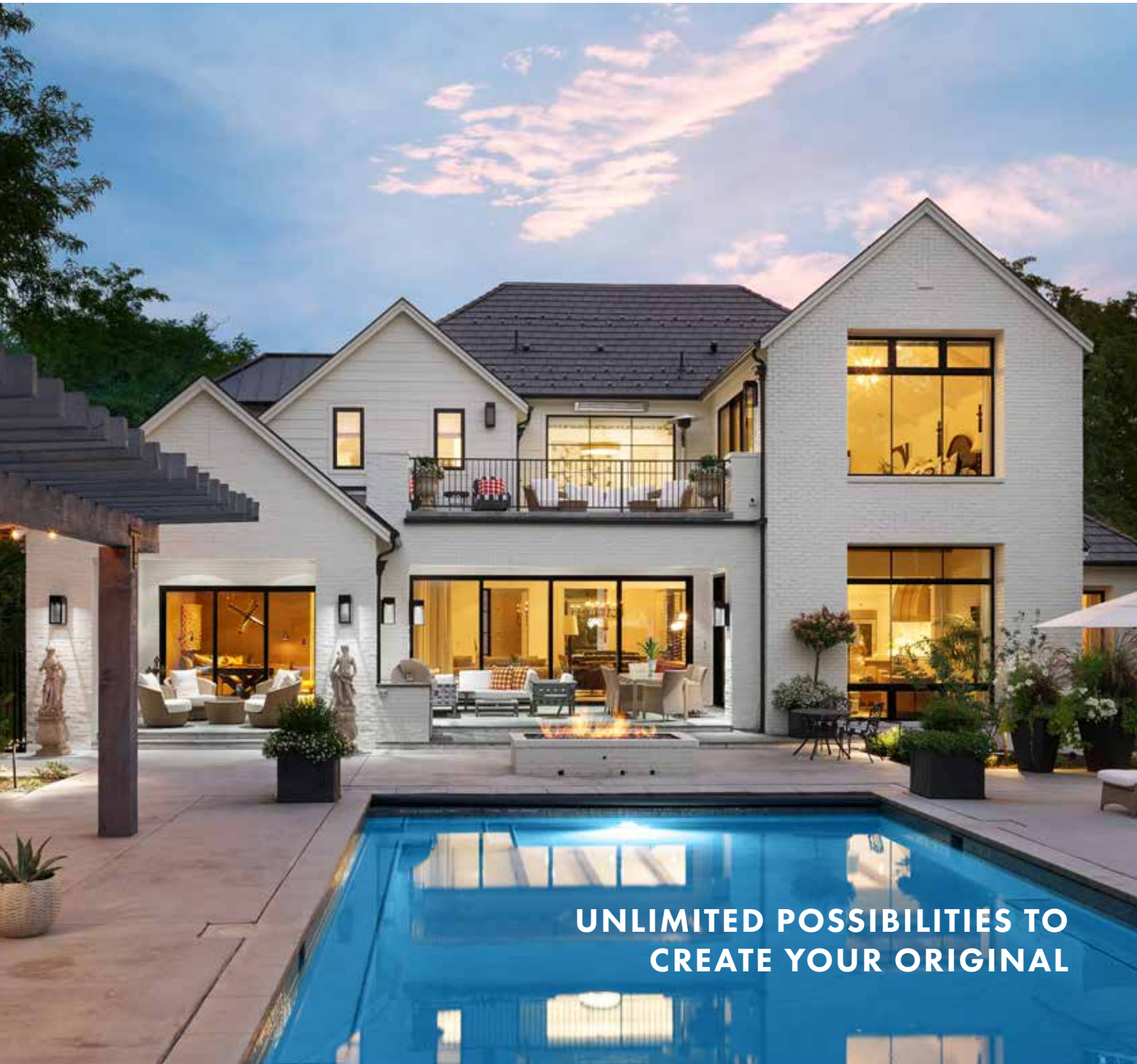

**UNLIMITED POSSIBILITIES TO  
CREATE YOUR ORIGINAL**

# CONTENTS

## E-SERIES WINDOWS & PATIO DOORS

Performance & Durability .....	2
Contemporary Style .....	5
Unlimited Combinations .....	6
Exteriors .....	7
Interiors .....	12
Exterior & Interior Trim .....	16
Unlimited Views .....	18
Glass .....	20
Stormwatch® Protection .....	21
Grilles .....	22
Insect Screens, Blinds & Shades .....	24
Window Hardware & Smart Home Solutions .....	26
Patio Door Hardware .....	28
Environmental Responsibility .....	30

Casement Windows .....	32
Casement Windows .....	34
French Casement Windows .....	36
Push Out Casement Windows .....	38
Awning Windows .....	63
Awning Windows .....	50
Push Out Awning Windows .....	52
Double-Hung Windows .....	56
Double-Hung Windows .....	58
Double-Hung Insert (RetroFit) Windows .....	60
Double-Hung Sash Replacement Kit .....	62
Bay & Bow Windows .....	80
Gliding (Slide-By) Windows .....	92
Specialty (Auxiliary) Windows .....	98

Hinged Patio Doors .....	103
Gliding Patio Doors .....	142

Installation Materials .....	154
Product Performance .....	163

For warranty information, visit [andersenwindows.com/warranty](https://andersenwindows.com/warranty).





## **E-SERIES WINDOWS & PATIO DOORS**

E-Series windows and patio doors are made to your exact specifications for unmatched flexibility and design freedom. These premier products allow you to create custom shapes, dramatic sizes and striking combinations to set your work apart. 50 standard exterior colors, custom colors and anodized finishes, plus a range of interior wood species and beautiful interior stains. Or, if your customers want something even more distinctive, we can source virtually any wood species they desire. If it's possible, it's possible with E-Series windows and patio doors. For more information, visit [andersenwindows.com/e-series](https://andersenwindows.com/e-series).

# MADE STRONG

Aluminum is a distinguishing element that enables us to offer the strength, beauty and design freedom for which E-Series products are known. Through decades of innovation, we have elevated the extruded aluminum-clad window and patio door category and perfected a made-to-order process that is unsurpassed.

## STRENGTH

We harness the full strength of aluminum with heavy gauge, extruded aluminum-clad wood sash and frames. Our thick cladding offers greater structural capabilities than thinner, roll-form aluminum, while providing a superior exterior finish that resists the elements of inclement weather, abrasion and impact.\*

## BEAUTY

Aluminum offers a smooth finish and versatility in design that enables us to create windows and doors with distinctive character and unparalleled beauty. It provides an essential foundation for our quality, baked-on silicone polyester finish, and it enables us to offer a broad array of unique accessory metals to create or recreate the architectural style you need. And beauty doesn't stop on the outside — we give you the design freedom you need to create a look of distinction both inside and out.

## VERSATILITY

Aluminum's strength and versatility allow us to offer beautiful made-to-order design solutions for practically any combination of shapes and styles you can imagine. We offer dozens of exterior accessory metals to match any architectural style, and our colorful 2-, 3- and 4-tone exteriors truly broaden your creative palette.

## DURABILITY

Our aluminum cladding withstands nature's toughest elements — the extrusions slide onto the wood and are secured independently, allowing both wood and aluminum to expand and contract naturally. Our products are engineered to open, close, support, swing or slide reliably day after day.\*

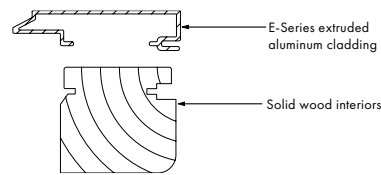

A solid wood core and extruded aluminum cladding give E-Series windows both strength and flexibility in many design applications.



E-Series casement window with Terratone exterior color.

\*Visit [andersenwindows.com/warranty](http://andersenwindows.com/warranty) for details.

# ENGINEERED FOR PERFORMANCE & DURABILITY

## ENERGY-SAVING GLASS FOR ANY CLIMATE

Andersen makes windows and patio doors with options that make them ENERGY STAR® v. 6.0 certified throughout the United States. Visit [andersenwindows.com/energystar](https://andersenwindows.com/energystar) for more information and to verify that the product with your glass option is ENERGY STAR certified in your area.



## LOW-MAINTENANCE EXTERIORS

Baked-on silicone polyester enamel exteriors offer virtually maintenance-free performance and durability. They're warranted for 10 years against chalking and color change and for 20 years against cracking, checking, peeling, flaking, blistering and loss of adhesion.\*



## PROTECTION FOR COASTAL AREAS

E-Series windows and patio doors with Stormwatch® Protection meet building code requirements in many Gulf and Atlantic coast states. See your local building code official for specific requirements. Visit [andersenwindows.com/coastal](https://andersenwindows.com/coastal) for more information.



## BUILT FOR YEARS TO COME

Our renowned Owner-2-Owner® limited warranty is fully transferrable and not prorated, making it one of the best coverage plans available – which means it can add resale value for your customers. It's also supported by the industry's largest service network.\*



\*Visit [andersenwindows.com/warranty](https://andersenwindows.com/warranty) for details.



# CONTEMPORARY STYLE

Modern home styles incorporate clean lines, simple forms and open floor plans. They often feature floor-to-ceiling windows or doors with narrow profiles to maximize light and view, have multiple units arranged in rectangular groupings and use dark colors or metal finishes. E-Series products are available in these options to let you create a contemporary style.



Interior of door shown with 3 1/16" contemporary panel profile.

## CONTEMPORARY DESIGNS

Dark colors and narrow profile options on windows, patio doors and even grille options offer a truly contemporary style.



Contemporary grille profile in black with a black spacer bar.

## BEAUTY

Durable, stainless steel FSB® hardware features clean lines in a satin finish for a thoroughly modern look. See FSB hardware options on page 29.

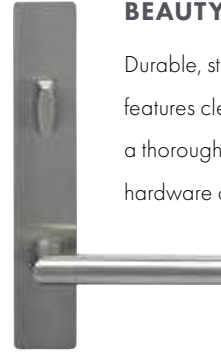

## SLEEK INTERIORS

High-quality, factory-applied interior finishes offer convenience along with beauty. For a modern look, choose a black or anodized silver painted interior.



## BRING YOUR VISION TO LIFE

Andersen has done extensive research into many architectural styles and how windows and patio doors play a critical role in achieving them. We've compiled it all into our Home Style Library. Whether you're looking for a modern home style or something more traditional, our library shows how easily you can achieve each style with our Andersen® products. To view our complete Home Style Library, visit [andersenwindows.com/stylelibrary](http://andersenwindows.com/stylelibrary).



Miesian Modern



Industrial Modern



International Modern

# UNLIMITED COMBINATIONS

E-Series windows and patio doors are made to your exact design specifications. Because we make your window or door especially for you, and since our options are virtually limitless, you have the advantage of combining shapes, sizes and styles for new construction or remodeling applications.

## BUILDING BLOCKS

Our complete window and door styles are your building blocks for making any architectural statement. We give you the products and the design freedom you need to create the perfect solution for your project whether residential or commercial, new construction or remodeling. Unique shapes in varying combinations create focal points that become defining architectural elements.

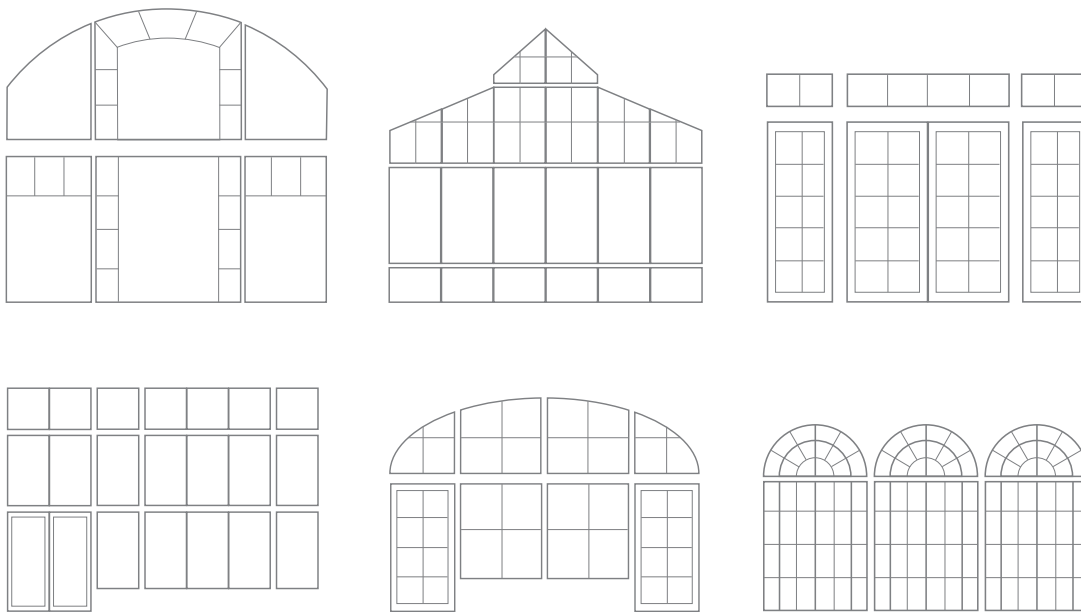

## SIZING OPTIONS

We believe you shouldn't have to settle for "close enough." Our made-to-order process enables us to make your windows and doors to the specific size you need. So when you go from inspirational sketch to architectural drawing, know that we will fulfill your design needs. We provide a thorough range of sizes for most applications and offer custom sizing anytime you need it.





## UNLIMITED EXTERIORS

Color enhances your design and is a vital element of every architectural style. We believe it shouldn't have to cost more which is why our 50 exterior colors, an industry-leading modern palette, are available at no additional cost. Add to that our 2-, 3- and 4-tone exteriors and set your E-Series windows and doors apart from the rest.

If your inspiration comes from an autumn leaf, a river-washed stone, a glass of fine wine or even a classic car, we will bring it to life with our custom color capabilities. And for a look of distinction, we offer seven spectacular anodized finishes that truly shine.





# 50 EXTERIOR COLORS

Our exclusive line of exterior colors offers a broad spectrum of quality, baked-on, silicone polyester enamel exteriors that meet AAMA 2604 specification. AAMA 2605 color compliance is also available.\* Our limited warranty covers exteriors for 10 years against chalking and color change and 20 years against cracking, checking, peeling, flaking, blistering and loss of adhesion.\*\*

## EXTERIOR COLORS



## 7 ANODIZED FINISHES

Choose from a spectacular selection of anodized finishes. Anodizing is a process that penetrates the aluminum like a stain penetrates wood. The result is a rich, lustrous metallic appearance that cannot peel or flake and is not affected by sunlight.\*\* This process produces a harder, more durable finish that makes this a perfect choice for high-traffic areas in commercial or residential buildings.

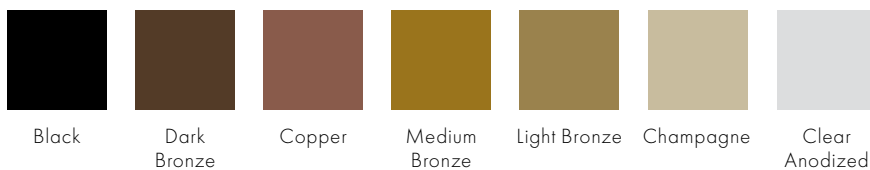

\*AAMA 2605 finishes are available in any of our 50 colors or select a custom color of your choice.

\*\*Visit [andersenwindows.com/warranty](http://andersenwindows.com/warranty) for details.

Printing limitations prevent exact color and finish replication. See your Andersen supplier for actual color and finish samples.



## CUSTOM COLORS

While our large selection of exterior colors covers a lot of ground, inspiration comes in infinite hues. Let us match a paint chip, a photograph, a favorite work of art to bring your dream color into the light of day.

## 2-, 3- AND 4-TONE EXTERIORS

With our 2-, 3- and 4-tone color combinations, the sky's the limit. Mix and match up to four of our 50 exterior colors on the frame, sash, exterior trim and grilles for a combination look that's all your own.



Country Blue and Stormy Blue



Sage, Moss and Canvas

## A RANGE OF INTERIORS

Natural wood adds character to your design and defines a room's character while creating a warm, comfortable space that leaves a lasting impression. We offer distinctive wood varieties, custom wood species and interior stain and paint options to meet your design needs.





# DISTINCTIVE WOOD SELECTIONS

Our distinctive woods add uncommon flair to any room. Each option has its own character, grain and staining capabilities, so you can select one that makes your windows stand out or one that blends seamlessly with your interior décor.

## INTERIOR WOOD SPECIES



Pine

Mixed Grain  
Douglas Fir

Oak

Maple

Hickory

Mahogany\*

Cherry

Walnut

Vertical Grain  
Douglas Fir

Alder

## CUSTOM WOOD INTERIORS

If a unique wood species is required to complete your project, we will try to source any variety that meets our production standards and your needs.

\*Actual wood species is either Sapele or Sipo, both non-endangered species grown in Africa, with color and characteristics similar to Central American mahoganies.

Wood species shown are unfinished.

Naturally occurring variations in grain, color and texture of wood make each window one of a kind. We cannot guarantee consistency in wood grain and/or color within a particular species, product or project.





# VARIETY OF INTERIOR FINISHES

Our high-quality, factory-applied stains offer you convenience along with beauty. Before staining, each wood component is treated with a preservative and insect repellent and dried thoroughly. We apply two coats of polyurethane for a long-lasting,\* durable finish, and because every exposed edge is stained before the window is assembled, you get a complete, consistent finish. Choose from nine stain colors. If you prefer a painted interior, choose one of our painted or primed options.

## STAINED INTERIOR OPTIONS



Clear Coat    Wheat    Autumn Oak    Golden Hickory    Honey    Cinnamon    Russet    Mocha    Espresso

All stained interior finish options are shown on pine.

## PAINTED INTERIOR OPTIONS



White    Birch Bark    Primed (for paint)    Canvas    Sandtone    Terratone    Forest Green



Dark Bronze    Dove Gray    Prairie Grass    Red Rock    Cocoa Bean    Black    Anodized Silver

Painted interior options are available on pine.  
Dark bronze and black also available on maple.  
Anodized silver available on maple only.

## CUSTOM STAINS, PAINTS & COLOR MATCHING

When only a specific tint will do, we will create one for you, matching existing woodwork, interior furnishings or other items for just the right finish to your design.

\*Visit [andersenwindows.com/warranty](http://andersenwindows.com/warranty) for details.

Please note that custom finishes and primed option require additional finishing. Some nail and staple holes may need to be filled prior to applying the final finish. Printing limitations prevent exact finish and color replication. See your Andersen supplier for actual finish and color samples.

# EXTERIOR & INTERIOR TRIM OPTIONS

Details take your project from ordinary to extraordinary. The perfect finishing touches make every window and patio door an irreplaceable part of any home or commercial building. We offer the trim and accessory metals that make the final details of your project easier to complete and more beautiful to look at.

## EXTERIOR TRIM

Designed to add depth and traditional appeal, our exterior trim options extend outward from the window or door frame, casting a shadow line consistent with true historical applications. Choose from our extended selection of flat and profiled casings, brick mould casings and sill nose. Match or contrast the trim with your windows and doors in any of our 50 exterior colors, custom colors and anodized finishes.



3 1/2" backband and bead casing and 1 1/2" sill nose shown on casement



3 1/2" flat casing shown on hinged inswing patio door



2" brick mould and 1 1/2" sill nose shown on casement



3 1/2" brick mould and 1 1/2" deep sill nose shown on double-hung

## INTERIOR TRIM COMPONENTS

### Extension Jamb

Pre-installed, dimensional extension jambs save time on jobsites and help enable a perfect installation. Available in all wood species, extension jambs can accommodate a wide variety of wall conditions.



### Drywall Returns

We offer drywall returns in three depths:

1 1/16", 3/16" and 7/16"



### Wood Casing

A subtle touch around the perfect window or door makes your view even more special. Choose from four different casings and add plinth blocks at the corners for just the right touch of detail.

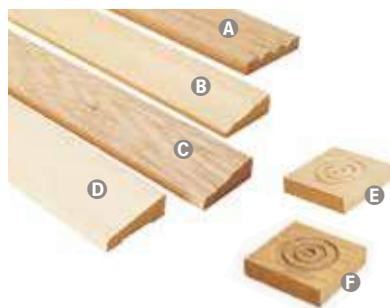

- A** 1/2" x 3 1/4" Fluted Casing
- B** 1 1/16" x 2 1/4" Colonial Casing (WM366)
- C** 1 1/16" x 2 1/4" Colonial Casing (WM356)
- D** 1 1/16" x 2 1/4" Ranch Casing (WM324)
- E** 2 1/2" Plinth Block
- F** 3 1/2" Plinth Block



# UNLIMITED VIEWS

Whether your design demands performance, clarity or architectural detail, we have the glass and divided light solutions to make your views spectacular. For performance needs in a variety of environments, we offer a multitude of glass options, including our High-Performance Low-E4® glass and our exclusive Stormwatch® impact-resistant product systems for severe weather conditions.\*

And for visual impact, made-to-order decorative glass and grilles give you infinite possibilities, so your design will be as original as your inspiration.

\*See your local code official for building code requirements in your area.





# GLASS OPTIONS

We offer a multitude of glass options to meet all of your design needs. Whether you're in need of energy efficiency or resistance to harsh weather conditions, we provide the solutions for you.

**Low-E4® Glass**, our standard glass option, provides excellent insulation from heat and cold. Compared to ordinary dual-pane glass, High-Performance Low-E4 glass is up to 44% more energy efficient in winter and up to 57% more efficient in summer.\* Or consider Sun glass with its soft, glare-controlling tint.

**Low-E4 Passive Sun® Glass** is a great solution for colder climate zones where higher heat gain is desired. It allows a higher amount of the sun's heat to pass into the home, making it an ideal solution for passive solar applications.

**Low-E4 SmartSun™ Glass** combines performance with clarity — letting more light in and keeping more heat out. It blocks 95% of the sun's damaging ultraviolet rays. Enjoy the performance benefits of tinted glass without the loss of visibility.

**Triple-Pane Glass** with three panes of glass, combined with Low-E coatings, can provide enhanced energy performance. Adding triple-pane glass can produce a lower U-Factor than using regular dual-pane glass.

**HeatLock® Technology** can increase the energy efficiency of any E-Series window or door with Low-E4 or SmartSun glass. Applied to the room-side glass surface, it reflects heat back into the home and improves U-Factors, which can help the window or door meet ENERGY STAR® requirements.

**Laminated Glass** offers sound protection, forced entry and impact resistance. It reduces unwanted outside noise, making it ideal for locations like airports and high-volume traffic areas.

**Decorative & Specialty Glass** options are also available. See our decorative glass collection at [andersenwindows.com/artglass](http://andersenwindows.com/artglass) or combine beveled, frosted, grooved, colored or textured glass with three coming options to create your own design. Specialty glass includes tinted glass, spandrel glass and Mapes panels as well as rain, reeded and obscure glass options.

A removable translucent film shields glass from damage and simplifies finishing and cleaning on the jobsite.

GLASS	ENERGY		LIGHT	
	U-Factor How well a product prevents heat from escaping.	Solar Heat Gain Coefficient How well a product blocks heat caused by sunlight.	Visible Light Transmittance How much visible light comes through a product.	UV Protection How well a product blocks ultraviolet rays.
SmartSun™	● ● ● ○	● ● ● ●	● ● ● ○	● ● ● ●
SmartSun with HeatLock® Coating	● ● ● ●	● ● ● ●	● ● ○ ○	● ● ● ●
Low-E4®	● ● ● ○	● ● ● ○	● ● ● ○	● ● ● ○
Low-E4 with HeatLock Coating	● ● ● ●	● ● ● ○	● ● ● ○	● ● ● ○
Sun	● ● ● ○	● ● ● ●	● ○ ○ ○	● ● ● ○
Passive Sun	● ● ● ○	● ○ ○ ○	● ● ● ○	● ● ● ○
Triple-Pane	● ● ● ●	● ● ● ○	● ● ● ○	● ● ● ●
Clear Dual-Pane	● ○ ○ ○	○ ○ ○ ○	● ● ● ●	○ ○ ○ ○

Center of glass performance only. Ratings based on glass options available as of January 2019. Visit [www.andersenwindows.com/energystar](http://www.andersenwindows.com/energystar) for ENERGY STAR® map and NFRC total unit performance data.

\*Winter and summer values are based on comparison of E-Series 3866 double-hung window U-Factor to the U-Factor for clear dual-pane glass non-metal frame default values from the 2006, 2009, 2012, 2015 and 2018 International Energy Conservation Code "Glazed Fenestration" Default Tables. See your Andersen supplier for actual glass samples.

"ENERGY STAR" is a registered trademark of the U.S. Environmental Protection Agency.

# STORMWATCH® PROTECTION

Designed for use in coastal areas, these systems combine monolithic or insulated laminated glass with structural enhancements to meet or exceed the stringent code requirements of ASTM and TAS testing protocols.\* You get the performance you need with the design options you want.

## PRODUCT AVAILABILITY

Choose from a variety of coastal windows including casement, awning, double-hung\*\* and fixed windows. Impact-resistant double-hung windows utilize two or more snuggers applied to the sill, creating a structural connection between the lower sash and frame. Simply close and lock the window and it's ready to withstand even the toughest weather conditions.†

We also offer a variety of coastal patio doors including inswing patio doors (impact-resistant insulated glass options only), outswing patio doors and French gliding patio doors. Surface bolts are required for impact certification of double doors.

Plus, you can select any of our 50 exterior colors, anodized finishes or custom colors. Choose from a variety of wood species, interior finishes, hardware, grille options, VeriLock® sensors and more. The only options not available on coastal products are decorative glass, blinds and shades.

## PERFORMANCE & DURABILITY

Impact-resistant glass provides windborne debris protection,† reduced sound transmission and burglar resistance

Designed to satisfy:

- AAMA/WDMA/CSA 101/I.S.2/A440-08 & -11
- Large missile impact test ASTM E1886/E1996
- TAS 201, 202, 203 (excluding inswing patio doors)
- Peace of mind with 24/7 protection



Double-hung window with Stormwatch Protection.

## Impact-Resistant Insulated Glass Options†

- Low-E
- SmartSun™
- Bronze or Gray
- Bronze/Bronze or Gray/Gray (meets Florida Turtle Code)

## Impact-Resistant Monolithic Glass Options†

- Low-E
- SmartSun
- Bronze, Gray or Green
- Clear



\*See your local code official for building code requirements in your area.

\*\*Double-hung windows are only available with impact-resistant monolithic bronze, gray, green and clear glass options.

†E-Series Casement 3060 HP Impact DP+65/-75 (AAMA/WDMA/CSA 101/I.S.2/A440-08 & -11). For more information, visit [andersenwindows.com/e-series](http://andersenwindows.com/e-series).



# ARCHITECTURALLY AUTHENTIC GRILLES

We offer a variety of grille styles and patterns to choose from, or design your own with varying lines, curves and shapes.

## FULL DIVIDED LIGHT (MODERN DIVIDED LIGHT)

Give any window an authentic look with full divided light grilles that are permanently applied to the interior and exterior of your window with a spacer between the glass. Available in ovolo (colonial) and contemporary profiles.

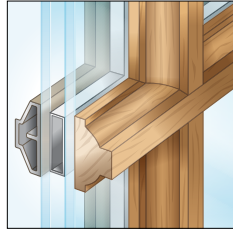

Shown with chamfer exterior grille and ovolo interior grille profiles.

## SIMULATED DIVIDED LIGHT (CLASSIC DIVIDED LIGHT)

An economical solution with traditional beauty, our simulated divided light features fixed exterior and interior grilles without an internal spacer. Available in ovolo and contemporary profiles.

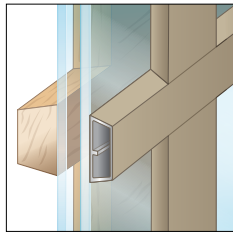

Shown with contemporary exterior and interior grille profiles.

### Profiles and Widths – Interior Grilles

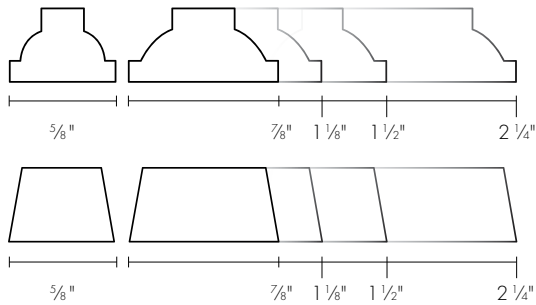

### Profiles and Widths – Exterior Grilles

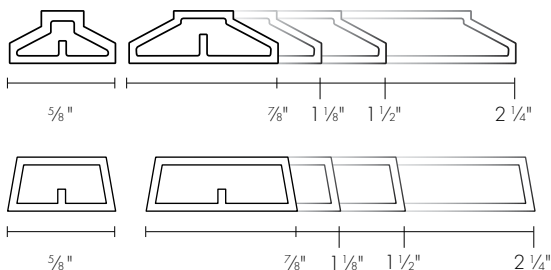

## REMOVABLE INTERIOR WOOD GRILLES

Our removable wood grilles are installed on the interior surface. They are available with an optional surround and an optional permanently applied exterior grille. Available in ovolo and contemporary profiles.

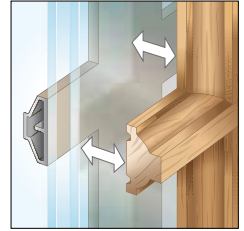

Shown with ovolo profile and optional permanently applied exterior grille with chamfer profile.

### Profiles and Widths

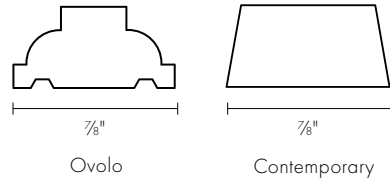

## FINELIGHT™ GRILLES-BETWEEN-THE-GLASS

Aluminum grilles conveniently placed between two panes of glass make the glass easy to clean inside and out.

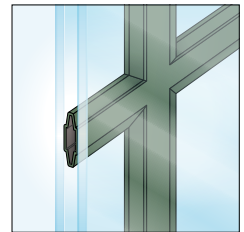

Shown with 1" contoured profile.

### Profiles and Widths

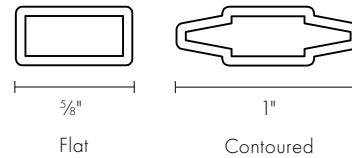

5/8" Color Options	1" Color Options
Colony White	Sierra Bronze/Colony White
Sierra Bronze	Pebble Tan/Colony White
Pebble Tan	Forest Green/Colony White
Forest Green	Choose from our broad palette of 50 colors or select from the two-tone paint combinations shown above.





## DESIGN YOUR OWN GRILLES

We offer a variety of grille patterns to choose from, or design your own with varying lines, curves and shapes to create a truly unique pattern.

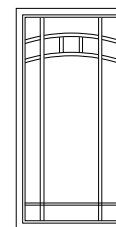
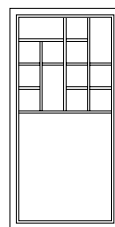
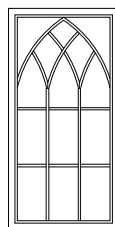
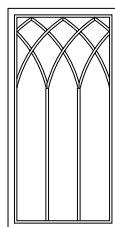
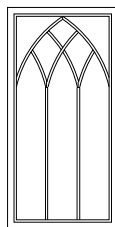
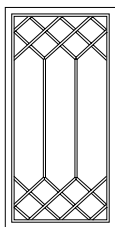
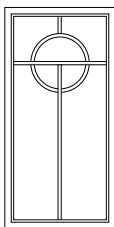
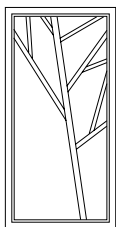

# SCREEN OUT THE INSECTS, NOT THE VIEW

E-Series insect screens let the beauty of the outdoors in, while keeping even small insects out. Choose from a wide selection of insect screen styles, including options that blend seamlessly with your window.



Conventional  
Insect Screen

TruScene  
Insect Screen



Retractable  
Insect Screen

## TRUSCENE® INSECT SCREENS\*

TruScene insect screens for windows are made with a micro-fine stainless steel mesh that offers 50% more clarity than our conventional aluminum mesh insect screens. TruScene insect screens let in more fresh air and sunlight and keep small insects out.

## WOOD VENEER INSECT SCREENS

For a clean appearance, E-Series interior window insect screens can feature a wood veneer to blend into your window.

## RETRACTABLE INSECT SCREEN FOR PATIO DOORS\*\*

This insect screen is built with an innovative color-matched aluminum housing that hides the insect screen when not in use. It's there when you need it and gone when you don't.

## RETRACTABLE INSECT SCREENS FOR WINDOWS AND PATIO DOORS

Retractable insect screens for casement and awning windows offer a sleek addition to any home. In place, the insect screen keeps insects out. When retracted, it provides a beautiful clear view.

For patio doors,\*\* retractable insect screens are built with an innovative color-matched housing that hides the insect screen when not in use. It's there when you need it and gone when you don't.

## HINGED INSECT SCREEN

Available for hinged inswing patio doors, this solid insect screen offers a full-door view and features a lockable latch and automatic closer.

## TOP-HUNG GLIDING INSECT SCREEN FOR PATIO DOORS

Open your room to the outdoors with the touch of a finger. Our top-hung gliding insect screen provides smooth and reliable operation, season after season.†

\*TruScene wood-veneered insect screens utilize a different frame profile than other E-Series wood-veneered insect screens.  
\*\*Retractable insect screens are available on inswing, outswing and gliding patio doors. See your Andersen supplier for details.  
†Visit [andersenwindows.com/warranty](http://andersenwindows.com/warranty) for details.

All comparisons are made to conventional E-Series aluminum insect screens.

# BETWEEN-THE-GLASS BLINDS & SHADES

What could be more convenient than blinds or shades between the panes of glass? Minimal cleaning and no worry about damage. It's simply a fitting way to put privacy at your fingertips. E-Series blinds and shades offer the ultimate in practicality for both residential and commercial applications.

## BLINDS-BETWEEN-THE-GLASS

E-Series blinds-between-the-glass can be installed in many of our patio doors and rectangular picture windows. Placed between the two panes of glass away from dust, dirt and damage, you get the benefit of energy efficiency and privacy control and convenience of blinds.



Blinds-Between-the-Glass

## SYSTEM 3 BLINDS & SHADES

Add privacy and even greater energy efficiency with this low-maintenance blind or shade solution. Applied to the interior of the sash, the System 3 design creates a triple-glazed window for incredible energy efficiency. Our 3/4" blinds and pleated shades are available for casement, awning and picture windows, plus hinged patio doors, and are mounted to an extruded aluminum storm panel and applied to the interior of the sash. The removable storm panel is available in tan, gold, white or wood veneer.

### Control Knobs



### Shades

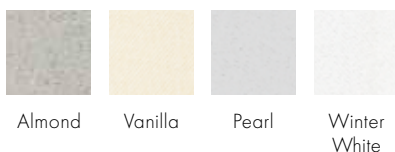

### Blinds



System 3 Shades    System 3 Blinds

\*Not all sizes of blinds-between-the-glass are retractable.  
 Printing limitations prevent exact color duplication. See your Andersen supplier for actual color samples.

# WINDOW HARDWARE

Complement a home's decor with E-Series window hardware, available in a variety of finishes.

## Casement & Awning



Operator Handle & Cover

Antique Brass | Black | Bright Chrome | Bronze | Gold  
Oil Rubbed Bronze | Pewter | Polished Brass | Satin Chrome | White

## Push Out Casement & Awning



Lock Handle



Insect Screen Pull

Antique Brass | Black  
**Oil Rubbed Bronze**  
Polished Brass  
Satin Chrome | White

## French Casement



Operator Handle & Cover

Antique Brass | **Black** | Bright Chrome | Bronze  
Polished Brass | Satin Chrome | White



Sash Lock

## Double-Hung



Sash Lift



Lock

Antique Brass | Black | Bright Chrome | Bronze | Gold  
Oil Rubbed Bronze | **Pewter** | Polished Brass | Satin Chrome | White



Optional sash lock with VeriLock® security sensor shown in black. See page 27 for more information.

## Gliding Windows



Lock



Slim Line Sash Pull

Antique Brass  
**Black** | Bright Chrome  
Bronze | Gold  
Oil Rubbed Bronze  
Pewter | Polished Brass  
Satin Chrome | White

**Black**  
Bronze  
Gold  
Polished Brass  
White

Bold name denotes finish shown.

## HARDWARE FINISHES



Antique Brass | Black | Bright Chrome | Bronze | Gold | Oil Rubbed Bronze | Pewter | Polished Brass | Satin Chrome | White

\*Hardware sold separately.

Oil rubbed bronze is a "living" finishes that will change with time and use. Printing limitations prevent exact finish replication. See your Andersen supplier for actual finish samples.

# THE SMARTEST TECHNOLOGY FOR THE SMARTEST HOMES

Andersen® E-Series windows and doors can now be part of today’s connected home. Monitor the status of your windows and patio doors anytime and from anywhere with our sensor options.\* Plus, our new Yale® Assure Lock®, shown on page 29, lets you remotely lock or unlock your hinged patio doors.† Learn more about the convenience and peace of mind Andersen smart home products offer at [andersenwindows.com/connect](http://andersenwindows.com/connect).



Double-Hung Sash Lock VeriLock Security Sensor



Open/Closed Sensor

## VERILOCK® SECURITY SENSORS

With the most advanced technology in the industry, VeriLock security sensors not only indicate whether windows and patio doors are open or closed, they even indicate if they are locked or unlocked.† No other sensor can do that.

**Maintains Warranty** – No drilling required which can void warranties.

**Helps Maximize Energy Efficiency** – Windows that are closed but unlocked lose air at a rate up to 3X that of a closed and locked window.\*\* VeriLock sensors tell you which windows and patio doors are open or unlocked\* so you can help manage air loss.

**Preserves Beauty** – Available in a variety of colors to complement many Andersen hardware or interior finishes.

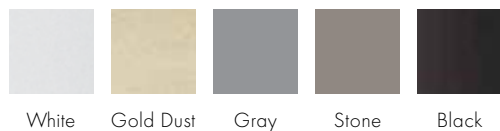

White Gold Dust Gray Stone Black

## WIRELESS OPEN/CLOSED SENSORS

These wireless sensors provide the peace of mind of knowing whether your windows and patio doors are open

**Easy Installation** – No tools are required to install our sensors. Simply place the sensor on a window or patio door and line up the magnet with the sensor until the LED glows blue!†

**Maintains Warranty** – No drilling required which can void warranties.

**Compact Design** – Sleek, compact design in a variety of colors to blend in with the window or patio door.



White Canvas Sandtone Dark Bronze

\*When properly configured and maintained with a professionally installed security system and/or self-monitoring system compatible with Honeywell® 5800 controls. See your Andersen supplier for more information.

\*\*Based on testing of thirty-two (32) A-Series double-hung windows. Air loss through unlocked windows will vary based on window type and age, pressure differential, temperatures inside and outside the home, altitude and application.

†See product installation for details.

Printing limitations prevent exact color duplication. See your Andersen supplier for actual color samples.

# PATIO DOOR HARDWARE

E-Series patio door hardware is available in a variety of different designs to match virtually any style. Yuma®, Encino®, Anvers®, Newbury®, Covington™ and Whitmore® hardware options feature solid drop-forged brass for added strength, while Albany and Tribeca® hardware options are made of zinc die cast with durable powder-coated finishes.



**YUMA**  
Distressed Bronze  
**Distressed Nickel**



**ENCINO**  
Distressed Bronze  
Distressed Nickel



**NEWBURY**  
Antique Brass | Bright Brass  
Brushed Chrome | **Oil Rubbed Bronze**  
Polished Chrome | Satin Nickel



**ANVERS**  
Bright Brass | Oil Rubbed Bronze  
**Satin Nickel**



**COVINGTON**  
Antique Brass | **Bright Brass**  
Oil Rubbed Bronze



**WHITMORE**  
Antique Brass | Bright Brass  
Oil Rubbed Bronze | Satin Nickel



**ALBANY**  
Black | **Gold Dust**  
Stone | White



**TRIBECA**  
Stone | **White**

Bold name denotes finish shown.

## HARDWARE FINISHES



Hardware sold separately.

Distressed bronze and oil rubbed bronze are "living" finishes that will change with time and use.

Bright brass and satin nickel finishes on patio door hardware feature a 10-year limited warranty.

Printing limitations prevent exact finish replication. See your Andersen supplier for actual finish samples.



### FSB® HINGED PATIO DOOR HARDWARE

Durable, stainless steel FSB hinged door hardware features clean lines and a sleek satin finish for a thoroughly modern look.



### YALE® ASSURE LOCK®

Monitor, lock and unlock from anywhere with the Yale Assure Lock. This slim, sleek keyless lock is designed exclusively for Andersen hinged patio doors and integrates with a wide range of smart home platforms.

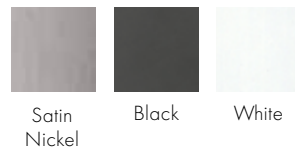

**One Touch Locking** – Lock up without the hassle of keys by simply tapping the keypad.

**Key Free** – No cylinder means no lost keys and no pick and bump break-ins.

**Battery Backup** – Never lose power, the lock can be energized with a 9V battery.

**Three Connectivity Options** – Touchscreen, Bluetooth® + WiFi and Z-Wave®

**Smart Home Integration** – Monitor, lock and unlock from anywhere.

Hardware sold separately.  
 Yale manufactures and supports the limited warranty for Yale Assure Lock for Andersen patio doors.  
 All marks where denoted are trademarks of their respective owners.  
 Printing limitations prevent exact finish replication. See your Andersen supplier for actual finish samples.

# ENVIRONMENTAL RESPONSIBILITY

It is more essential than ever that we all do our part to help protect the environment. While environmental responsibility may be new to some, to us, making environmentally responsible manufacturing decisions is nothing new. We've made responsible choices in the past and will continue to strive to be responsible in the future.

## PRESERVING NATURE

To protect our natural resources, we use wood harvested from managed forests and leverage engineered wood technology whenever possible — we use finger-jointed wood and laminated veneer lumber, both of which use wood efficiently and result in superior performance. In addition, we use water-based finishes, which have less impact on the environment than oil-based products.

## CONSERVING ENERGY

Our technology and design innovation creates greater energy efficiency in all our products. Our High-Performance Low-E4® glass provides superior thermal protection, helping significantly reduce heating and cooling requirements. Additional energy-efficient glass options include triple-pane glass and SmartSun™ glass. Combined with weathertight frames, sash and weatherstrip, E-Series windows and doors play an important role in energy conservation.



High-Performance Low-E4 glass is up to 45% more energy efficient in winter and up to 57% more energy efficient in summer compared to ordinary dual-pane glass.\*

## USING RECLAIMED MATERIALS

Our cladding contains pre-consumer reclaimed aluminum, which requires much less energy to process than virgin aluminum. In addition, our glass utilizes reclaimed glass, which reduces landfill waste.

## REDUCING WASTE

We recycle whenever possible — office paper, corrugated cardboard, sawdust, scrap aluminum, paints and solvents. Our electrostatic paint system attracts the paint to the aluminum, creating an efficient use of materials. Packaging enhancements include frame protectors made of HDPE, a recyclable plastic.

## TAKING AN ACTIVE ROLE

We work closely with the industry organizations shown to manufacture energy-efficient and environmentally responsible products.



## ENVIRONMENTAL CERTIFICATIONS

E-Series windows and doors have received SCS Global Services (SCS) Indoor Advantage™ Gold certification for indoor air quality. Indoor air quality is an important issue because many people spend as much as 90% of their time indoors, either at home, work or school.



\*Winter and summer values are based on comparison of E-Series 3866 double-hung window U-Factor to the U-Factor for clear dual-pane glass non-metal frame default values from the 2006, 2009, 2012, 2015 and 2018 International Energy Conservation Code "Glazed Fenestration" Default Tables.

All marks where denoted are trademarks of their respective owners.





# CASEMENT WINDOWS

Simple, beautiful and extremely functional, this casement window offers enhanced energy performance. Plus, stainless steel hinges and tracks that open to 90° for great ventilation and easy cleaning. In addition, a single-lever, multi-point locking mechanism with minimally exposed hardware offers a sleek, modern look.

---

<b>Casement Overview</b> .....	<b>34</b>
<b>French Casement Overview</b> .....	<b>36</b>
<b>Push Out Casement Overview</b> .....	<b>38</b>
Sizing	
Casement .....	40
Casement Picture & Transom .....	41
Arch Casement .....	42
French Casement .....	43
Push Out Casement .....	44
Details .....	45
Installation Materials .....	154
Product Performance .....	158





# CASEMENT WINDOW

## FEATURES

### CASEMENT WINDOWS

#### FRAME & SASH

**A** Select wood components are kiln dried and treated with water/insect repellent and preservative. Interior wood surfaces are available in pine, mixed grain Douglas fir, cherry, hickory, mahogany\*, maple, oak, walnut, alder or vertical grain Douglas fir. Interior surfaces are available unfinished or factory primed. Factory-applied finishes are available in a variety of stain and paint options.

**B** Wood components are fitted with aluminum extrusions on the exterior. 50 exterior colors that meet AAMA 2604 and 2605 specifications are available, as well as custom colors. Also available is a selection of seven exterior anodized options. Integral, butyl-backed corner keys provide a positive, tight seal.

Vinyl installation flanges are pre-applied into a kerf on the frame exterior to facilitate installation. Optional aluminum flanges and metal installation clips are available.

**C** A Fibrex® material thermal barrier encompasses the interior perimeter of the frame and is a neutral beige color.

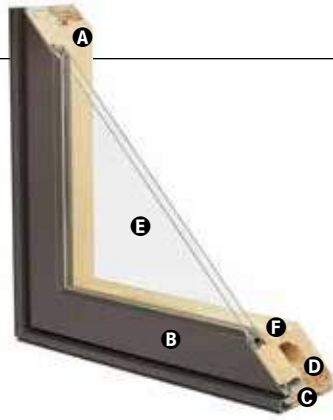
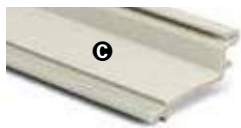

**D** A continuous perimeter bulb weatherstrip around the frame is positioned on the Fibrex material thermal barrier and provides solid surface contact with the sash.

A secondary bulb weatherstrip is applied on three sides of the sash into a stand-alone kerf on the aluminum extrusion. Available in white or optional black.

#### GLASS

**E** High-Performance Low-E4® glass with a low-conductivity spacer. Triple-pane glass, tinted, clear dual-pane, high-altitude glass and other special glazing options are available.

**F** Glass is fixed in place from the interior with wood stops that can be removed for easy reglazing if necessary. Glass stops available in ovolo (colonial) and contemporary profiles.

#### HARDWARE

Equipped with a stainless steel gear operator, concealed hinges and hinge track. Arch casement units use stainless steel piano hinges.

Locks, handles and operator covers are available in 10 finishes and can be shipped separately closer to job completion.

#### Sash Locks



Concealed sash locks (multi-point on units taller than 2'-8") provide a positive lock by operating one convenient lever. Stainless steel keepers resist corrosion.\*\* Available in finishes to match operator handles.

## HARDWARE OPTIONS



Antique Brass | **Black**  
Bright Chrome | Bronze  
Gold | Oil Rubbed Bronze  
Pewter | Polished Brass  
Satin Chrome | White

Bold name denotes finish shown.

#### HARDWARE FINISHES



Oil rubbed bronze is a "living" finish that will change with time and use.

## EXTERIOR & INTERIOR OPTIONS

**EXTERIOR COLORS** 50 exterior colors, 7 anodized finishes and custom colors. See exterior colors on page 11.

#### INTERIOR WOOD SPECIES

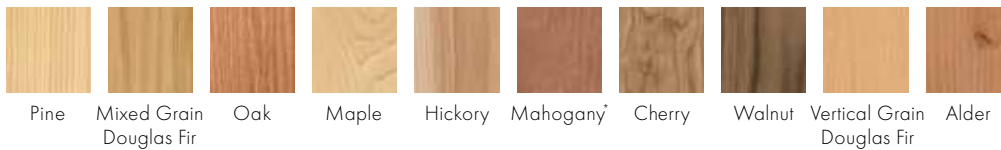

Interior custom stains, paints and color matching available.

Naturally occurring variations in grain, color and texture of wood make each window one of a kind.

All factory-finished options are shown on pine.

#### FACTORY-FINISHED INTERIORS

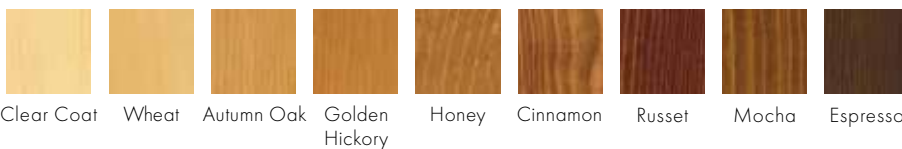

Painted options available on pine. Dark bronze and black painted options available on pine or maple. Anodized silver painted option available on maple only.

#### INTERIOR PAINTED OPTIONS

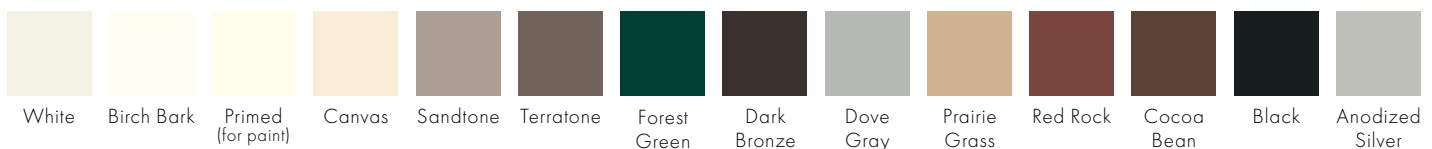

\*Actual wood species is either Sapele or Sipo, both non-endangered species grown in Africa, with color and characteristics similar to Central American mahoganies.

\*\*Visit [andersenwindows.com/warranty](http://andersenwindows.com/warranty) for details.

Printing limitations prevent exact replication of colors and finishes. Please see your Andersen supplier for actual color and finish samples.

## ACCESSORIES Sold Separately

### CASEMENT WINDOWS

#### HARDWARE

##### Power Operator



Power operators are available in bronze, white, black or gold.

##### Window Opening Control Device Kit

An optional Window Opening Control Device Kit is available, which limits opening the sash to less than 4" when the window is first opened. Available in stone and white.

##### Construction Hardware



Construction locks and operator handles keep your permanent window hardware away from the construction process and possible damage yet allow operation of windows during construction.

#### SENSORS

##### VeriLock® Security Sensors

VeriLock sensors are unique as they detect whether the windows are locked or unlocked\* — a feature no other sensors can provide. See page 27 for Smart Home options.

##### Open/Closed Sensors

Wireless open/closed sensors are available in four colors. See page 27 for details.

#### PRIVACY OPTIONS

##### System 3 Blinds



A 5/8" aluminum slat blind is mounted to an extruded aluminum blind panel and applied to the window, creating a triple-glazed window boasting privacy and energy efficiency. Available in three colors. Blind panels are offered in white, tan, gold or an optional wood veneer to match your interior.

##### System 3 Shades

Pleated fabric shades are available in four colors to effortlessly and beautifully filter the light. See page 25 for more details.

#### INSECT SCREENS

##### Conventional Insect Screens



Charcoal fiberglass screen mesh fits into an aluminum frame in colors of bronze, white or gold as well as optional black. Aluminum screen mesh and wood-veneered insect screen also available as options.

##### TruScene® Insect Screens



TruScene insect screens available in painted aluminum or wood-veneered options.

##### Retractable Insect Screens

Retractable insect screen available in wood-veneered options.

See page 24 for more information on our insect screen options.

#### GRILLES

##### Full Divided Light

Permanent interior and exterior grilles with grille spacer bars between two panes of glass. Available in 5/8", 7/8", 1 1/8", 1 1/2", or 2 1/4" widths. Interior grilles are available with ovolo or contemporary profile (ovolo profile shown below). Not all widths are shown.



5/8"

7/8"



1 1/8"

1 1/2"

##### Simulated Divided Light

Permanent exterior and interior grilles without grille spacer bars. Available in 5/8", 7/8", 1 1/8", 1 1/2", or 2 1/4" widths. Interior grilles are available with ovolo or contemporary profile (ovolo profile shown below). Not all widths are shown.



7/8"

##### Finelight™ Grilles-Between-the-Glass

Available in 5/8" flat or 1" contoured aluminum profiles. Two-tone colors of pebble tan/colony white, sierra bronze/colony white or forest green/colony white are available on the 1" profile.



5/8" Flat

1" Contoured

##### Removable Interior Wood Grilles

Removable interior wood grilles are available in a 7/8" width and ovolo or contemporary profiles. Optional surround for removable grille and permanent exterior grilles also available.



7/8"

See page 22 for more information on grilles.

\*When properly configured and maintained with a professionally installed security system and/or self monitoring system compatible with Honeywell® 5800 controls. See your Andersen supplier for more information.

# FRENCH CASEMENT WINDOW

## FEATURES

### FRENCH CASEMENT WINDOWS

#### FRAME & SASH

**A** Select wood components are kiln dried and treated with water/insect repellent and preservative. Interior wood surfaces are available in pine, mixed grain Douglas fir, cherry, hickory, mahogany\*, maple, oak, walnut, alder or vertical grain Douglas fir. Interior surfaces are available unfinished or factory primed. Factory-applied finishes are available in a variety of stain and paint options.

**B** Wood components are fitted with aluminum extrusions on the exterior. 50 exterior colors that meet AAMA 2604 and 2605 specifications are available, as well as custom colors. Also available is a selection of seven exterior anodized options.

Vinyl installation flanges are pre-applied into a kerf on the frame exterior to facilitate installation. Optional aluminum flanges and metal installation clips are available.

**C** A Fibrex® material thermal barrier encompasses the interior perimeter of the frame and is a neutral beige color.

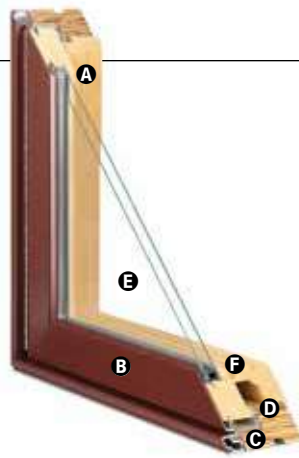
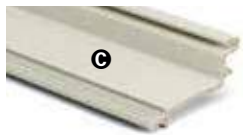

**D** A continuous perimeter bulb weatherstrip around the frame is positioned on the Fibrex material thermal barrier and provides solid surface contact with the sash.

Secondary weatherstrip is applied on three sides of the sash. Available in white or optional black.

#### GLASS

**E** High-Performance Low-E4® glass with a low-conductivity spacer. Tinted, clear dual-pane, high-altitude glass and other special glazing options are available.

**F** Glass is fixed in place from the interior with wood stops that can be removed for easy reglazing if necessary. Glass stops available in ovolo (colonial) and contemporary profiles.

#### HARDWARE

Equipped with stainless steel gear operators and piano hinges.

#### Sash Locks

Concealed, multi-point sash locks provide a positive lock by operating one convenient lever. Stainless steel keepers resist corrosion.\*\*



Antique Brass | **Black**  
Bright Chrome | Bronze  
Polished Brass  
Satin Chrome | White

## HARDWARE OPTIONS



Antique Brass | **Black**  
Bright Chrome | Bronze  
Polished Brass  
Satin Chrome | White  
Bold name denotes finish shown.

#### HARDWARE FINISHES

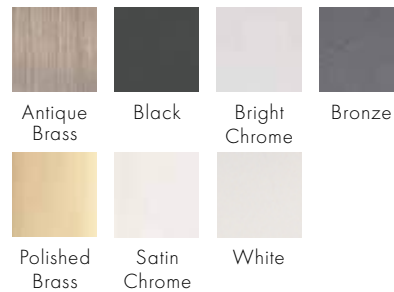

## EXTERIOR & INTERIOR OPTIONS

**EXTERIOR COLORS** 50 exterior colors, 7 anodized finishes and custom colors. See exterior colors on page 11.

#### INTERIOR WOOD SPECIES

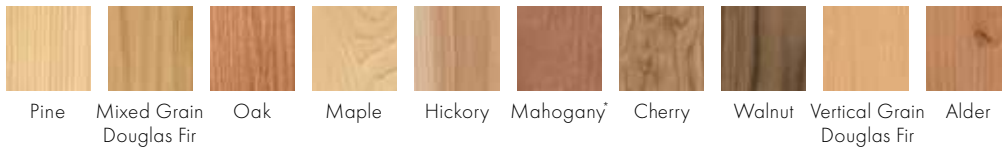

Interior custom stains, paints and color matching available.

Naturally occurring variations in grain, color and texture of wood make each window one of a kind.

All factory-finished options are shown on pine.

#### FACTORY-FINISHED INTERIORS



Painted options available on pine. Dark bronze and black painted options available on pine or maple. Anodized silver painted option available on maple only.

#### INTERIOR PAINTED OPTIONS

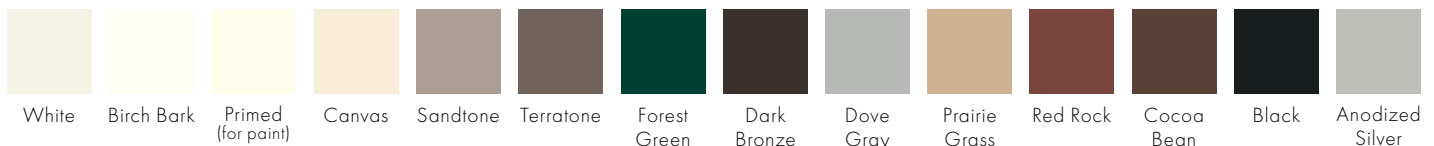

\*Actual wood species is either Sapele or Sipo, both non-endangered species grown in Africa, with color and characteristics similar to Central American mahoganies.

\*\*Visit andersenwindows.com/warranty for details.

Printing limitations prevent exact replication of colors and finishes. Please see your Andersen supplier for actual color and finish samples.

**ACCESSORIES** Sold Separately

**FRENCH CASEMENT  
WINDOWS**

**SENSORS**

**Open/Closed Sensors**

Wireless open/closed sensors are available in four colors. See page 27 for details.

**INSECT SCREENS**

**Conventional Insect Screens**



Charcoal fiberglass screen mesh fits into an aluminum frame in colors of bronze, white or gold as well as optional black. Aluminum screen mesh and wood-veneered insect screen also available as options.

**TruScene® Insect Screens**



TruScene insect screens available in painted aluminum or wood-veneered options.

**Retractable Insect Screens**

Retractable insect screen available in wood-veneered options.

See page 24 for more information on our insect screen options.

**GRILLES**

**Full Divided Light**

Permanent interior and exterior grilles with grille spacer bars between two panes of glass. Available in 5/8", 7/8", 1 1/8", 1 1/2", or 2 1/4" widths. Interior grilles are available with ovolo or contemporary profile (ovolo profile shown below). Not all widths are shown.



5/8"

7/8"



1 1/8"

1 1/2"

**Simulated Divided Light**

Permanent exterior and interior grilles without grille spacer bars. Available in 5/8", 7/8", 1 1/8", 1 1/2", or 2 1/4" widths. Interior grilles are available with ovolo or contemporary profile (ovolo profile shown below). Not all widths are shown.



7/8"

**Finelight™**

**Grilles-Between-the-Glass**

Available in 5/8" flat or 1" contoured aluminum profiles. Two-tone colors of pebble tan/colony white, sierra bronze/colony white or forest green/colony white are available on the 1" profile.



5/8" Flat

1" Contoured

**Removable Interior Wood Grilles**

Removable interior wood grilles are available in a 7/8" width and ovolo or contemporary profiles. Optional surround for removable grille and permanent exterior grilles also available.



7/8"

See page 22 for more information on grilles.

\*When properly configured and maintained with a professionally installed security system and/or self monitoring system compatible with Honeywell® 5800 controls. See your Andersen supplier for more information.

# PUSH OUT CASEMENT WINDOW

## FEATURES

### PUSH OUT CASEMENT WINDOWS

#### FRAME & SASH

**A** Select wood components are kiln dried and treated with water/insect repellent and preservative. Interior wood surfaces are available in pine, mixed grain Douglas fir, cherry, hickory, mahogany\*, maple, oak, walnut, alder or vertical grain Douglas fir. Interior surfaces are available unfinished or factory primed. Factory-applied finishes are available in a variety of stain and paint options.

**B** Wood components are fitted with aluminum extrusions on the exterior. 50 exterior colors that meet AAMA 2604 and 2605 specifications are available, as well as custom colors. Also available is a selection of seven exterior anodized options.

Vinyl installation flanges are pre-applied into a kerf on the frame exterior to facilitate installation. Optional aluminum flanges and metal installation clips are available.

**C** A Fibrex® material thermal barrier encompasses the interior perimeter of the frame and is a neutral beige color.

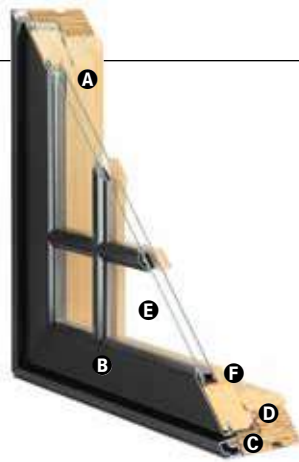
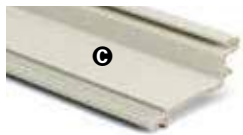

**D** A continuous perimeter bulb weatherstrip around the frame is positioned on the Fibrex material thermal barrier and provides solid surface contact with the sash.

A secondary bulb weatherstrip is applied on three sides of the sash. Available in white or optional black.

#### GLASS

**E** High-Performance Low-E4® glass with a low-conductivity spacer. Tinted, clear dual-pane, high-altitude glass and other special glazing options are available.

**F** Glass is fixed in place from the interior with wood stops that can be removed for easy reglazing if necessary. Glass stops available in ovolo (colonial) and contemporary profiles.

#### HARDWARE

Equipped with a stainless steel 4-bar friction hinge. Larger units use a stainless steel piano hinge with stainless steel stays.

Manual lock system featuring lock handles allows for easy operation. Units under 40" high use a single lock, while units 40" and taller use dual locks.

#### HARDWARE OPTIONS



Antique Brass | Black  
Oil Rubbed Bronze  
Polished Brass  
**Satin Chrome** | White

Bold name denotes finish shown.

#### HARDWARE FINISHES



Oil rubbed bronze is a "living" finish that will change with time and use.

## EXTERIOR & INTERIOR OPTIONS

**EXTERIOR COLORS** 50 exterior colors, 7 anodized finishes and custom colors. See exterior colors on page 11.

#### INTERIOR WOOD SPECIES

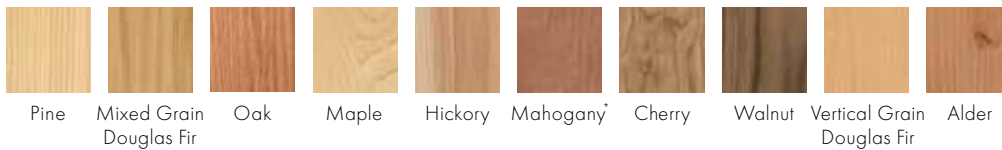

Interior custom stains, paints and color matching available.

Naturally occurring variations in grain, color and texture of wood make each window one of a kind.

All factory-finished options are shown on pine.

#### FACTORY-FINISHED INTERIORS



Painted options available on pine. Dark bronze and black painted options available on pine or maple. Anodized silver painted option available on maple only.

#### INTERIOR PAINTED OPTIONS

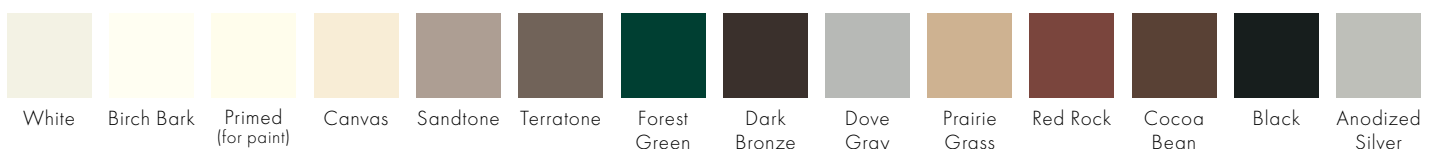

\*Actual wood species is either Sapele or Sipo, both non-endangered species grown in Africa, with color and characteristics similar to Central American mahoganies. Printing limitations prevent exact replication of colors and finishes. Please see your Andersen supplier for actual color and finish samples.



**ACCESSORIES** Sold Separately

**PUSH OUT CASEMENT WINDOWS**

**VeriLock® Security Sensors**

VeriLock sensors are unique as they detect whether the windows are locked or unlocked\* — a feature no other sensors can provide. See page 27 for Smart Home options.

**Open/Closed Sensors**

Wireless open/closed sensors are available in four colors. See page 27 for details.

**INSECT SCREENS**

**Hinged Insect Screens**



Oil Rubbed Bronze\*\*

Hinged insect screen opens to the interior, providing access to the lock handle. Choose from charcoal fiberglass or aluminum screen mesh. Available in wood-veneered options. Insect screen pulls are available in antique brass, black, oil rubbed bronze,\*\* polished brass, satin chrome and white.

**Retractable Insect Screens**

Retractable insect screen available in wood-veneered options. Extension jambs required for push out casement windows with retractable insect screens.

See page 24 for more information on our insect screen options.

**GRILLES**

**Full Divided Light**

Permanent interior and exterior grilles with grille spacer bars between two panes of glass. Available in 5/8", 7/8", 1 1/8", 1 1/2", or 2 1/4" widths. Interior grilles are available with ovolo or contemporary profile (ovolo profile shown below). Not all widths are shown.

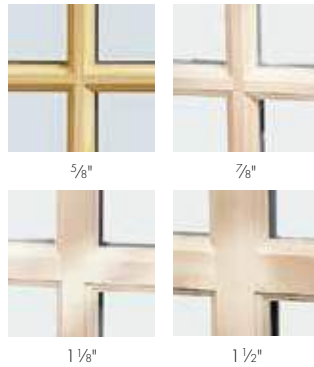

**Simulated Divided Light**

Permanent exterior and interior grilles without grille spacer bars. Available in 5/8", 7/8", 1 1/8", 1 1/2", or 2 1/4" widths. Interior grilles are available with ovolo or contemporary profile (ovolo profile shown below). Not all widths are shown.

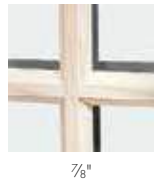

**Finelight™**

**Grilles-Between-the-Glass**

Available in 5/8" flat or 1" contoured aluminum profiles. Two-tone colors of pebble tan/colony white, sierra bronze/colony white or forest green/colony white are available on the 1" profile.



5/8" Flat

1" Contoured

**Removable Interior Wood Grilles**

Removable interior wood grilles are available in a 7/8" width and ovolo or contemporary profiles. Optional surround for removable grille and permanent exterior grilles also available.



7/8"

See page 22 for more information on grilles.

\*When properly configured and maintained with a professionally installed security system and/or self monitoring system compatible with Honeywell® 5800 controls. See your Andersen supplier for more information.

\*\*Oil rubbed bronze is a "living" finish that will change with time and use.

# CASEMENT WINDOWS

## Casement Window Sizes

	1' 6 1/4"	1' 8 1/2"	2' 0 1/2"	2' 4 1/2"	2' 6 1/2"	2' 8 1/2"	3' 0 1/2"
1' 5 3/4"							
2' 0"							
2' 6"							
2' 8 1/2"							
3' 0 1/2"							
3' 4"							
3' 4 1/2"							
3' 6"							
4' 0"							
4' 0 1/2"							
4' 6"							
4' 6 1/2"							
5' 0"							
5' 0 1/2"							
5' 6"							
6' 0"							
6' 0 1/2"							

### NOTES

† These units meet or exceed the following dimensions: Clear Opening Area 5.7 sq. ft., Clear Opening Width 20", Clear Opening Height 24" and 44" maximum floor to sill height (with standard 6' 10-1/2" structural header height).

†† Units meet the stated dimensions above when optional hardware for widest clear opening is used.

\* A sash-limiting device is standard on 2856 and 3050 casement units. See your local code official for requirements in your area.

\*\* A piano hinge and sash limiting device is standard on 2860, 3056 and 3060 casement units.

If glass is positioned within 18" of the finished floor, safety/tempered glass may be required. Local codes may differ. Verify tempered glass requirements with your local building code official.

Use structural joining material when necessary or required by code.

The light patterns illustrated apply to rectangular removable interior wood grilles, Full Divided Light, Simulated Divided Light, Decorelle 100, 150 and 400 and Finelight™ Grilles-Between-the-Glass. All removable interior wood grilles will be installed in the units unless otherwise specified.

For a metric conversion in millimeters, multiply dimensions in inches by 25.4.

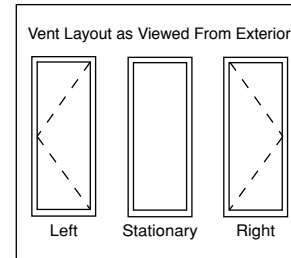

### FORMULA FOR COMBINATION WINDOWS

The overall frame dimension (both width and height) is equal to the sum of the individual unit frame dimensions plus joining material dimension(s).

The overall rough opening (both width and height) is equal to the overall frame dimensions plus 1/4" on all sides.

Any unit within each combination can be operating or stationary.

Joined Casement Combinations	2-Wide		3-Wide		4-Wide		5-Wide		
	Single Unit Frame Width	Rough Opening Width	Frame Width	Rough Opening Width	Frame Width	Rough Opening Width	Frame Width	Rough Opening Width	Frame Width
	1'-5 3/4"	3'-0"	2'-11 1/2"	4'-5 3/4"	4'-5 1/4"	5'-11 1/2"	5'-11"	7'-5 1/4"	7'-4 3/4"
	1'-8"	3'-4 1/2"	3'-4"	5'-0 1/2"	5'-0"	6'-8 1/2"	6'-8"	8'-4 1/2"	8'-4"
	2'-0"	4'-0 1/2"	4'-0"	6'-0 1/2"	6'-0"	8'-0 1/2"	8'-0"	10'-0 1/2"	10'-0"
	2'-4"	4'-8 1/2"	4'-8"	7'-0 1/2"	7'-0"	9'-4 1/2"	9'-4"	11'-8 1/2"	11'-8"
	2'-6"	5'-0 1/2"	5'-0"	7'-6 1/2"	7'-6"	10'-0 1/2"	10'-0"	12'-6 1/2"	12'-6"
	2'-8"	5'-4 1/2"	5'-4"	8'-0 1/2"	8'-0"	10'-8 1/2"	10'-8"	13'-4 1/2"	13'-4"
	3'-0"	6'-0 1/2"	6'-0"	9'-0 1/2"	9'-0"	12'-0 1/2"	12'-0"	15'-0 1/2"	15'-0"

FOR WINDOWS GREATER THAN 30 SQUARE FEET OR RATED HIGHER THAN PG50, ONE OF THESE THREE INSTALLATION METHODS IS REQUIRED: A) THROUGH THE JAMB B) ALUMINUM INSTALLATION FLANGE OR C) INSTALLATION CLIPS. ADDITIONAL CUSTOM SIZES ARE AVAILABLE. CONTACT YOUR LOCAL SUPPLIER FOR MORE INFORMATION. DRAWINGS ARE NOT TO SCALE.

**Casement Picture Window Sizes**

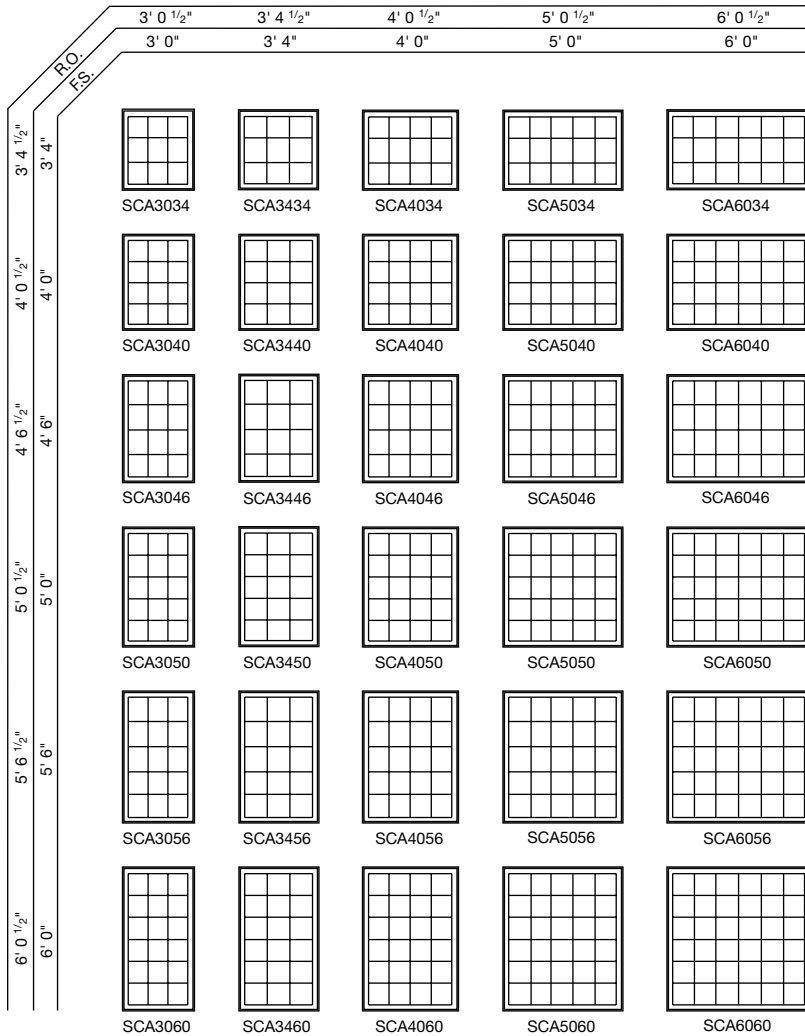

**NOTES**

If glass is positioned within 18" of the finished floor, safety/tempered glass may be required. Local codes may differ. Verify tempered glass requirements with your local building code official.

Use structural joining material when necessary or required by code.

The light patterns illustrated apply to rectangular removable interior wood grilles, Full Divided Light, Simulated Divided Light, Decorelle 100, 150 and 400 and Finelight™ Grilles-Between-the-Glass. All removable interior wood grilles will be installed in the units unless otherwise specified.

For a metric conversion in millimeters, multiply dimensions in inches by 25.4.

**FORMULA FOR COMBINATION WINDOWS**

The overall frame dimension (both width and height) is equal to the sum of the individual unit frame dimensions plus joining material dimension(s).

The overall rough opening (both width and height) is equal to the overall frame dimensions plus 1/4" on all sides.

Any unit within each combination can be operating or stationary.

**Casement Transom Window Sizes**

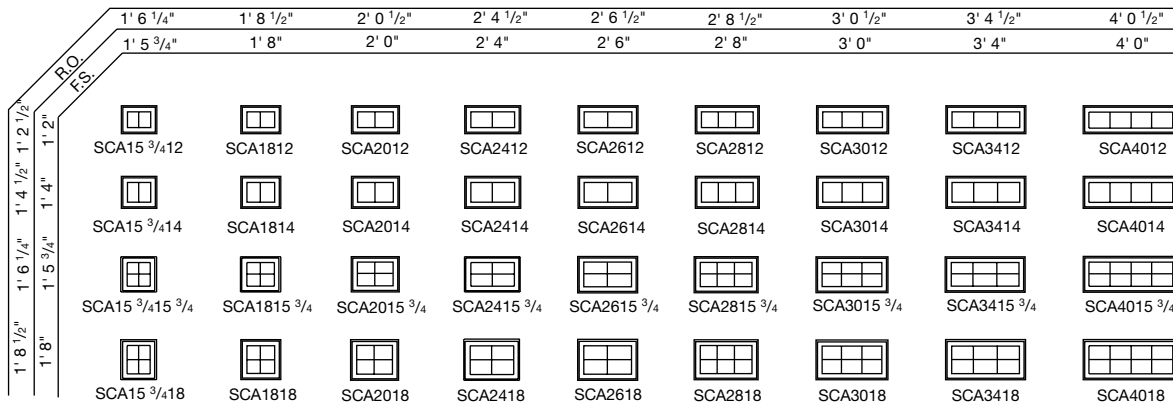

**FOR WINDOWS GREATER THAN 30 SQUARE FEET OR RATED HIGHER THAN PG50, ONE OF THESE THREE INSTALLATION METHODS IS REQUIRED:  
A) THROUGH THE JAMB B) ALUMINUM INSTALLATION FLANGE OR C) INSTALLATION CLIPS.  
ADDITIONAL CUSTOM SIZES ARE AVAILABLE. CONTACT YOUR LOCAL SUPPLIER FOR MORE INFORMATION. DRAWINGS ARE NOT TO SCALE.**

# CASEMENT WINDOWS

## Arch Casement Window Sizes

		2' 0 1/2"	4' 0 1/2"	2' 4 1/2"	4' 8 1/2"	2' 6 1/2"	5' 0 1/2"	2' 8 1/2"	5' 4 1/2"	3' 0 1/2"	6' 0 1/2"
		2' 0"	4' 0"	2' 4"	4' 8"	2' 6"	5' 0"	2' 8"	5' 4"	3' 0"	6' 0"
		3'-0" RAD	6'-0" RAD	3'-0" RAD	6'-0" RAD	3'-0" RAD	6'-0" RAD	3'-0" RAD	6'-0" RAD	3'-0" RAD	6'-0" RAD
R.O. F.S.	2' 0 1/2"										
	2' 0"	RCAX2020	RCAX2020-2	RCAX2420	RCAX2420-2	RCAX2620	RCAX2620-2	RCAX2820	RCAX2820-2	RCAX3020	RCAX3020-2
	2' 6 1/2"										
	2' 6"	RCAX2026	RCAX2026-2	RCAX2426	RCAX2426-2	RCAX2626	RCAX2626-2	RCAX2826	RCAX2826-2	RCAX3026	RCAX3026-2
	2' 8 1/2"										
	2' 8"	RCAX2028	RCAX2028-2	RCAX2428	RCAX2428-2	RCAX2628	RCAX2628-2	RCAX2828	RCAX2828-2	RCAX3028	RCAX3028-2
	3' 0 1/2"										
	3' 0"	RCAX2030	RCAX2030-2	RCAX2430	RCAX2430-2	RCAX2630	RCAX2630-2	RCAX2830	RCAX2830-2	RCAX3030	RCAX3030-2
	3' 4 1/2"										
	3' 4"	RCAX2034	RCAX2034-2	RCAX2434	RCAX2434-2	RCAX2634	RCAX2634-2	RCAX2834	RCAX2834-2	RCAX3034	RCAX3034-2
4' 0 1/2"											
4' 0"	RCAX2040	RCAX2040-2	RCAX2440 †	RCAX2440-2 †	RCAX2640 †	RCAX2640-2 †	RCAX2840 †	RCAX2840-2 †	RCAX3040 †	RCAX3040-2 †	
4' 6 1/2"											
4' 6"	RCAX2046	RCAX2046-2	RCAX2446 †	RCAX2446-2 †	RCAX2646 †	RCAX2646-2 †	RCAX2846 †	RCAX2846-2 †	RCAX3046 †	RCAX3046-2 †	
5' 0 1/2"											
5' 0"	RCAX2050	RCAX2050-2	RCAX2450 †	RCAX2450-2 †	RCAX2650 †	RCAX2650-2 †	RCAX2850 †	RCAX2850-2 †	RCAX3050 *	RCAX3050-2 *	
5' 6 1/2"											
5' 6"	RCAX2056	RCAX2056-2	RCAX2456 †	RCAX2456-2 †	RCAX2656 †	RCAX2656-2 †	RCAX2856 *	RCAX2856-2 *	RCAX3056 *	RCAX3056-2 *	
6' 0 1/2"											
6' 0"	RCAX2060	RCAX2060-2	RCAX2460 †	RCAX2460-2 †	RCAX2660 †	RCAX2660-2 †	RCAX2860 *	RCAX2860-2 *	RCAX3060 *	RCAX3060-2 *	

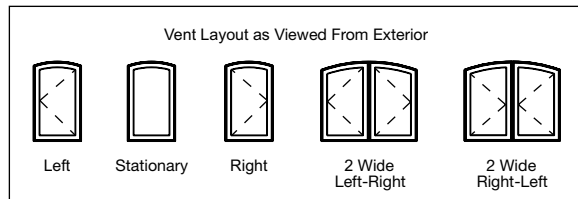

**NOTES**

† These units meet or exceed the following dimensions: Clear Opening Area 5.7 sq. ft., Clear Opening Width 20", Clear Opening Height 24" and 44" maximum floor to sill height (with standard 6' 10-1/2" structural header height).

\* A sash-limiting device is standard on 2856, 2860, 3056 and 3060 casement units. See your local code official for requirements in your area.

Piano hinges are standard on all arch casement units.

See notes on page 43 for more information.

**FOR WINDOWS GREATER THAN 30 SQUARE FEET OR RATED HIGHER THAN PG50, ONE OF THESE THREE INSTALLATION METHODS IS REQUIRED:**  
**A) THROUGH THE JAMB B) ALUMINUM INSTALLATION FLANGE OR C) INSTALLATION CLIPS.**  
**ADDITIONAL CUSTOM SIZES ARE AVAILABLE. CONTACT YOUR LOCAL SUPPLIER FOR MORE INFORMATION. DRAWINGS ARE NOT TO SCALE.**

**French Casement Window Sizes**

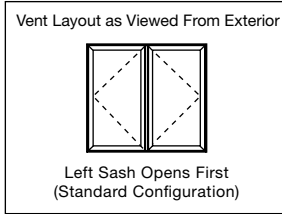
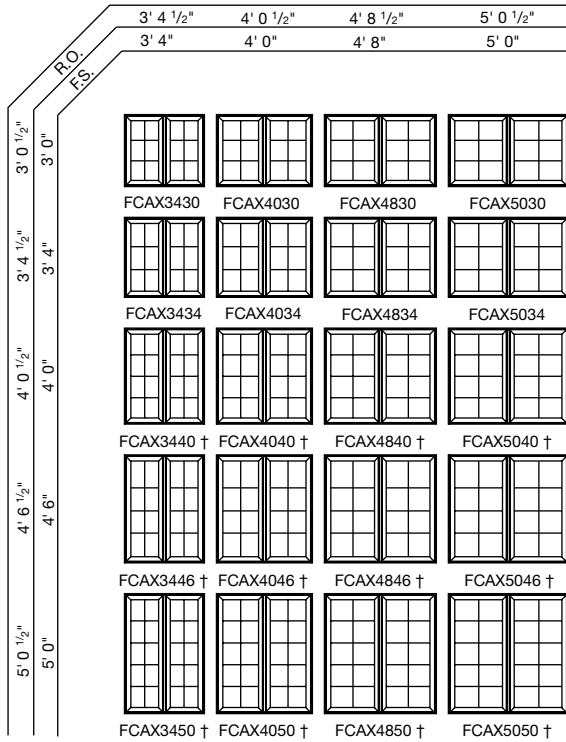

**NOTES**

† These units meet or exceed the following dimensions: Clear Opening Area 5.7 sq. ft., Clear Opening Width 20", Clear Opening Height 24" and 44" maximum floor to sill height (with standard 6' 10-1/2" structural header height). Local codes may differ. Verify egress requirements with your local building code official.

Piano hinges and step jamb are standard on all French casement units.

If glass is positioned within 18" of the finished floor, safety/tempered glass may be required. Local codes may differ. Verify tempered glass requirements with your local building code official.

Use structural joining material when necessary or required by code.

The light patterns illustrated apply to rectangular removable interior wood grilles, Full Divided Light, Simulated Divided Light, Decorelle 100, 150 and 400 and Finelight™ Grilles-Between-the-Glass. All removable interior wood grilles will be installed in the units unless otherwise specified.

For a metric conversion in millimeters, multiply dimensions in inches by 25.4.

**FORMULA FOR COMBINATION WINDOWS**

The overall frame dimension (both width and height) is equal to the sum of the individual unit frame dimensions plus joining material dimension(s).

The overall rough opening (both width and height) is equal to the overall frame dimensions plus 1/4" on all sides.

Any unit within each combination can be operating or stationary.

FOR WINDOWS GREATER THAN 30 SQUARE FEET OR RATED HIGHER THAN PG50, ONE OF THESE THREE INSTALLATION METHODS IS REQUIRED:  
A) THROUGH THE JAMB B) ALUMINUM INSTALLATION FLANGE OR C) INSTALLATION CLIPS.  
ADDITIONAL CUSTOM SIZES ARE AVAILABLE. CONTACT YOUR LOCAL SUPPLIER FOR MORE INFORMATION. DRAWINGS ARE NOT TO SCALE.

# CASEMENT WINDOWS

## Push Out Casement Window Sizes

	1' 6 1/4"	1' 8 1/2"	2' 0 1/2"	2' 4 1/2"	2' 6 1/2"	2' 8 1/2"	3' 0 1/2"
2' 0 1/2"							
2' 6 1/2"							
2' 8 1/2"							
3' 0"							
3' 4 1/2"							
4' 0 1/2"							
4' 6 1/2"							
5' 0 1/2"							
5' 6 1/2"							
6' 0"							

### NOTES

† These units meet or exceed the following dimensions: Clear Opening Area 5.7 sq. ft., Clear Opening Width 20", Clear Opening Height 24" and 44" maximum floor to sill height (with standard 6' 10-1/2" structural header height). Local codes may differ. Verify egress requirements with your local building code official.

Units ≤ 24" Actual Frame Width (AFW) will receive hinges only (no clip or friction arm).  
Units > 24" AFW and ≤ 30" AFW receive clip only.  
Units > 30" AFW receive (2) 14" friction arms.

If glass is positioned within 18" of the finished floor, safety/tempered glass may be required. Local codes may differ. Verify tempered glass requirements with your local building code official.

Use structural joining material when necessary or required by code.

The light patterns illustrated apply to rectangular removable interior wood grilles, Full Divided Light, Simulated Divided Light, Decorelle 100, 150 and 400 and Finelight™ Grilles-Between-the-Glass. All removable interior wood grilles will be installed in the units unless otherwise specified.

For a metric conversion in millimeters, multiply dimensions in inches by 25.4.

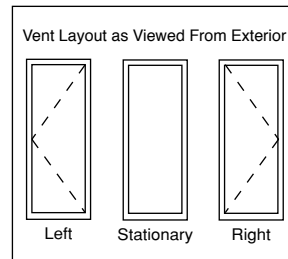

### FORMULA FOR COMBINATION WINDOWS

The overall frame dimension (both width and height) is equal to the sum of the individual unit frame dimensions plus joining material dimension(s).

The overall rough opening (both width and height) is equal to the overall frame dimensions plus 1/4" on all sides.

Any unit within each combination can be operating or stationary.

Joined Casement Combinations	2-Wide		3-Wide		4-Wide		5-Wide		
	Single Unit Frame Width	Rough Opening Width	Frame Width	Rough Opening Width	Frame Width	Rough Opening Width	Frame Width	Rough Opening Width	Frame Width
	1'-5 3/4"	3'-0"	2'-11 1/2"	4'-5 3/4"	4'-5 1/4"	5'-11 1/2"	5'-11"	7'-5 1/4"	7'-4 3/4"
	1'-8"	3'-4 1/2"	3'-4"	5'-0 1/2"	5'-0"	6'-8 1/2"	6'-8"	8'-4 1/2"	8'-4"
	2'-0"	4'-0 1/2"	4'-0"	6'-0 1/2"	6'-0"	8'-0 1/2"	8'-0"	10'-0 1/2"	10'-0"
	2'-4"	4'-8 1/2"	4'-8"	7'-0 1/2"	7'-0"	9'-4 1/2"	9'-4"	11'-8 1/2"	11'-8"
	2'-6"	5'-0 1/2"	5'-0"	7'-6 1/2"	7'-6"	10'-0 1/2"	10'-0"	12'-6 1/2"	12'-6"
	2'-8"	5'-4 1/2"	5'-4"	8'-0 1/2"	8'-0"	10'-8 1/2"	10'-8"	13'-4 1/2"	13'-4"
	3'-0"	6'-0 1/2"	6'-0"	9'-0 1/2"	9'-0"	12'-0 1/2"	12'-0"	15'-0 1/2"	15'-0"

FOR WINDOWS GREATER THAN 30 SQUARE FEET OR RATED HIGHER THAN PG50, ONE OF THESE THREE INSTALLATION METHODS IS REQUIRED:  
A) THROUGH THE JAMB B) ALUMINUM INSTALLATION FLANGE OR C) INSTALLATION CLIPS.  
ADDITIONAL CUSTOM SIZES ARE AVAILABLE. CONTACT YOUR LOCAL SUPPLIER FOR MORE INFORMATION. DRAWINGS ARE NOT TO SCALE.

**Casement Windows**

**Casement**

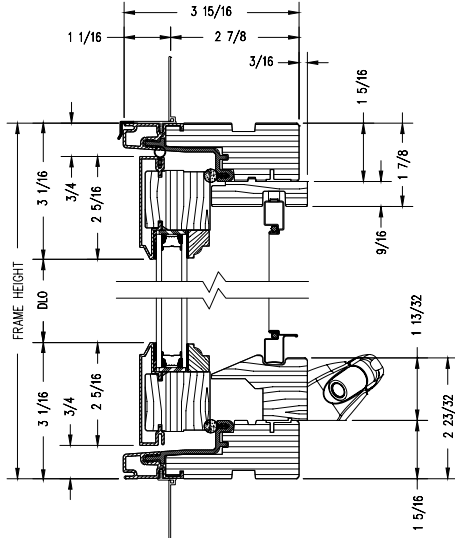

Vertical Section

**Sash-Set (2-Piece) Casement**

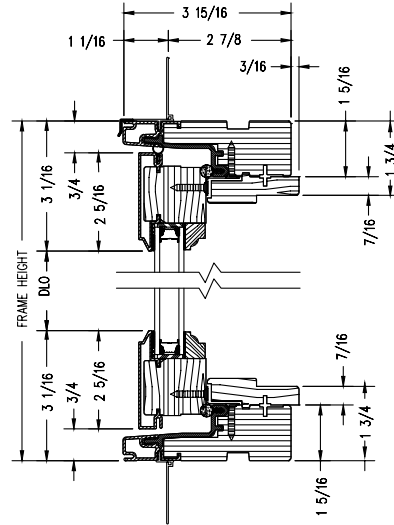

Vertical Section

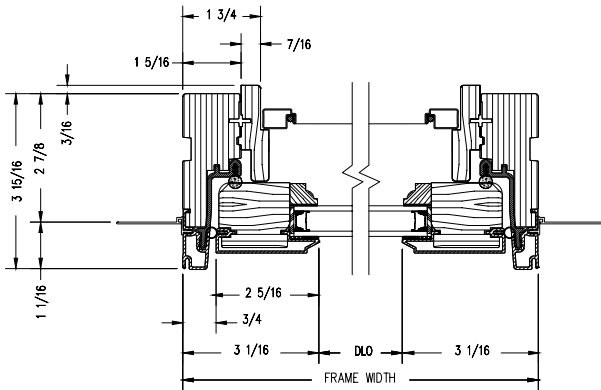

Horizontal Section

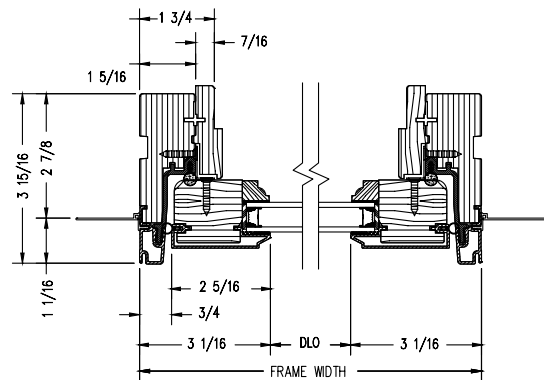

Horizontal Section

Shown with ovolo (colonial) glass stops.

PROPER INSTALLATION AND MAINTENANCE OF E-SERIES PRODUCTS IS ESSENTIAL TO ATTAIN OPTIMUM PERFORMANCE AND OPERATION. WRITTEN INSTALLATION INSTRUCTIONS THAT PROVIDE GUIDELINES FOR PROPER INSTALLATION ARE AVAILABLE BY VISITING [ANDERSENWINDOWS.COM](http://ANDERSENWINDOWS.COM). CUSTOM SIZES ARE AVAILABLE. CONTACT YOUR LOCAL SUPPLIER FOR MORE INFORMATION. DRAWINGS ARE NOT TO SCALE.

## Casement Windows

### Direct-Set (1-Piece) Casement

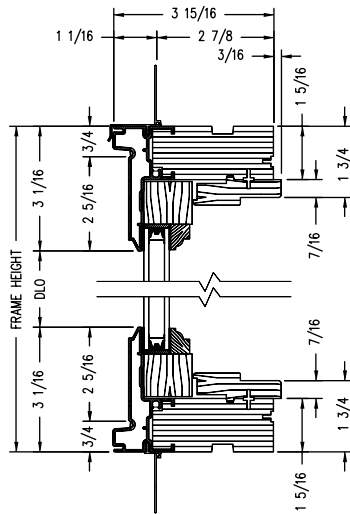

Vertical Section

### Arch Casement

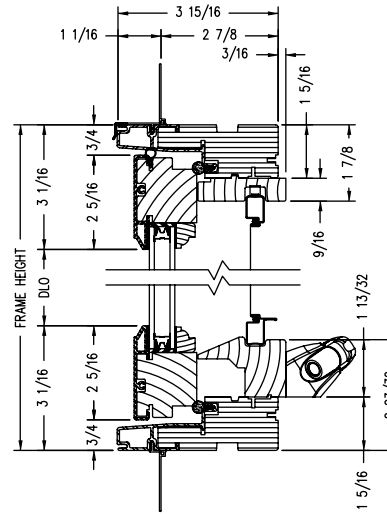

Vertical Section

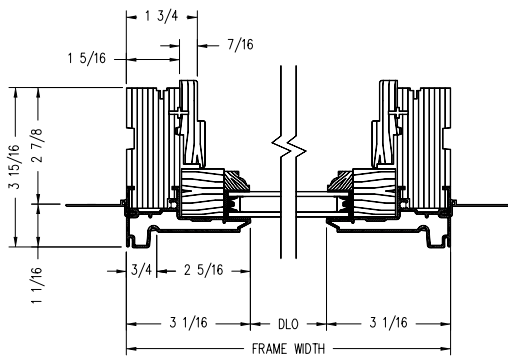

Horizontal Section

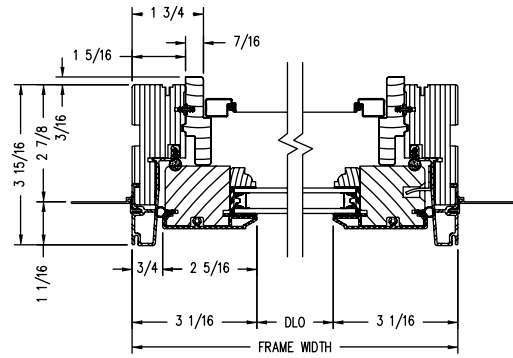

Horizontal Section

Shown with ovolo (colonial) glass stops.

PROPER INSTALLATION AND MAINTENANCE OF E-SERIES PRODUCTS IS ESSENTIAL TO ATTAIN OPTIMUM PERFORMANCE AND OPERATION. WRITTEN INSTALLATION INSTRUCTIONS THAT PROVIDE GUIDELINES FOR PROPER INSTALLATION ARE AVAILABLE BY VISITING [ANDERSENWINDOWS.COM](http://ANDERSENWINDOWS.COM). CUSTOM SIZES ARE AVAILABLE. CONTACT YOUR LOCAL SUPPLIER FOR MORE INFORMATION. DRAWINGS ARE NOT TO SCALE.



**French Casement Windows**

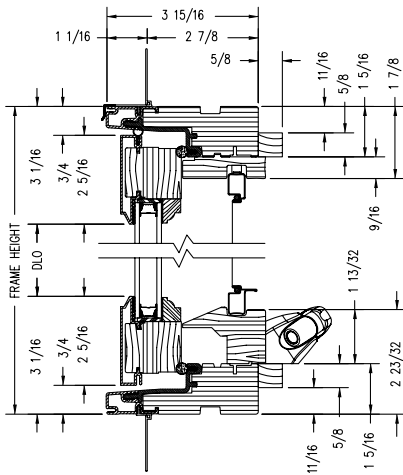

Vertical Section

**Push Out Casement Windows**

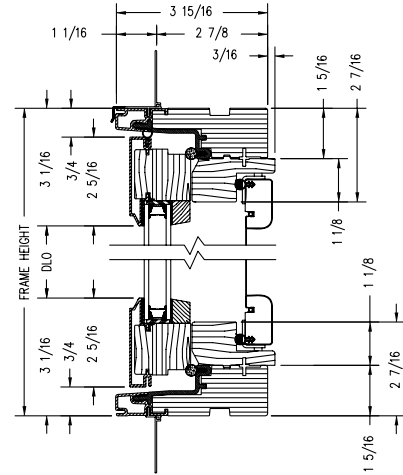

Vertical Section

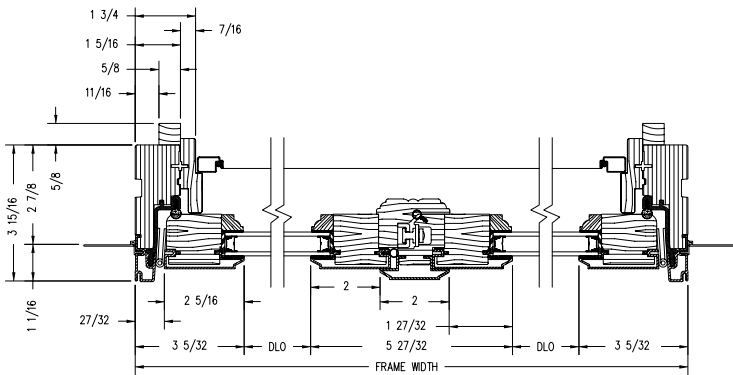

Horizontal Section

Shown with ovolo (colonial) glass stops.

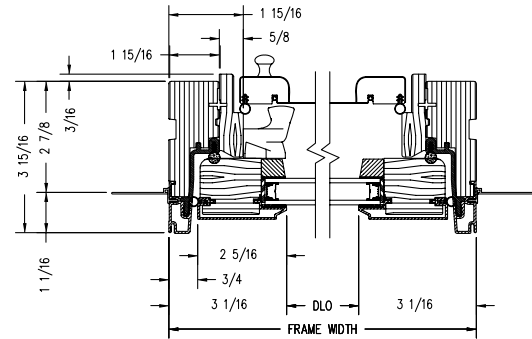

Horizontal Section

Shown with contemporary glass stops.

**PROPER INSTALLATION AND MAINTENANCE OF E-SERIES PRODUCTS IS ESSENTIAL TO ATTAIN OPTIMUM PERFORMANCE AND OPERATION. WRITTEN INSTALLATION INSTRUCTIONS THAT PROVIDE GUIDELINES FOR PROPER INSTALLATION ARE AVAILABLE BY VISITING [ANDERSENWINDOWS.COM](http://ANDERSENWINDOWS.COM). CUSTOM SIZES ARE AVAILABLE. CONTACT YOUR LOCAL SUPPLIER FOR MORE INFORMATION. DRAWINGS ARE NOT TO SCALE.**

# AWNING WINDOWS

Used alone or as an accent window, E-Series awning windows add visual interest and ventilation. Plus, they are easy to clean from the inside, while still offering a weathertight seal for outstanding performance. They include stainless steel hardware with the operator located on the sill for a true awning style and feature the same sight lines as our casement window for design flexibility when creating large window combinations.

---

<b>Awning Overview</b> .....	<b>50</b>
<b>Push Out Casement Overview</b> .....	<b>52</b>
Sizing	
Awning .....	54
Push Out Awning .....	54
Details .....	55
Installation Materials .....	154
Product Performance .....	158





# AWNING WINDOW

## FEATURES

### AWNING WINDOWS

#### FRAME & SASH

**A** Select wood components are kiln dried and treated with water/insect repellent and preservative. Interior wood surfaces are available in pine, mixed grain Douglas fir, cherry, hickory, mahogany\*, maple, oak, walnut, alder or vertical grain Douglas fir. Interior surfaces are available unfinished or factory primed. Factory-applied finishes are available in a variety of stain and paint options.

**B** Wood components are fitted with aluminum extrusions on the exterior. 50 exterior colors that meet AAMA 2604 and 2605 specifications are available, as well as custom colors. Also available is a selection of seven exterior anodized options. Integral, butyl-backed corner keys provide a positive, tight seal.

Vinyl installation flanges are pre-applied into a kerf on the frame exterior to facilitate installation. Optional aluminum flanges and metal installation clips are available.

**C** A Fibrex® material thermal barrier encompasses the interior perimeter of the frame and is a neutral beige color.

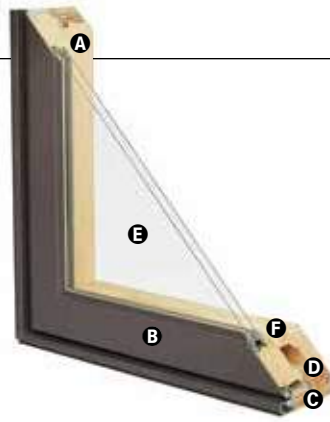
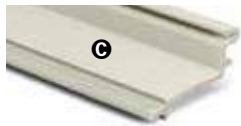

**D** A continuous perimeter bulb weatherstrip around the frame is positioned on the Fibrex material thermal barrier and provides solid surface contact with the sash.

A secondary bulb weatherstrip is applied on three sides of the sash into a stand-alone kerf on the aluminum extrusion. Available in white or optional black.

#### GLASS

**E** High-Performance Low-E4® glass with a low-conductivity spacer. Triple-pane glass, tinted, clear dual-pane, high-altitude glass and other special glazing options are available.

**F** Glass is fixed in place from the interior with wood stops that can be removed for easy reglazing if necessary. Glass stops available in ovolo (colonial) and contemporary profiles.

#### HARDWARE

Equipped with a stainless steel gear operator, concealed hinges and hinge track.

Locks, handles and operator covers are available in 10 finishes and can be shipped separately closer to job completion.



Concealed sash locks provide a positive lock. Stainless steel keepers resist corrosion.\*\* Available in finishes to match operator handles.

### HARDWARE OPTIONS



Antique Brass | **Black**  
Bright Chrome | Bronze  
Gold | Oil Rubbed Bronze  
Pewter | Polished Brass  
Satin Chrome | White

Bold name denotes finish shown.

#### HARDWARE FINISHES



Oil rubbed bronze is a "living" finish that will change with time and use.

## EXTERIOR & INTERIOR OPTIONS

**EXTERIOR COLORS** 50 exterior colors, 7 anodized finishes and custom colors. See exterior colors on page 11.

#### INTERIOR WOOD SPECIES

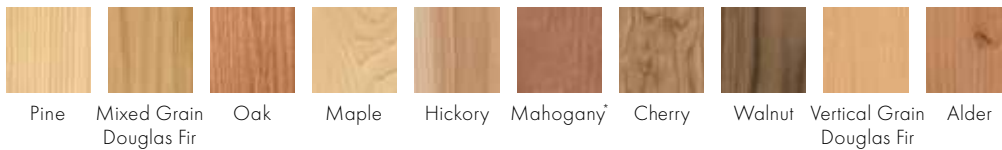

Naturally occurring variations in grain, color and texture of wood make each window one of a kind.

All factory-finished options are shown on pine.

Painted options available on pine. Dark bronze and black painted options available on pine or maple. Anodized silver painted option available on maple only.

#### FACTORY-FINISHED INTERIORS

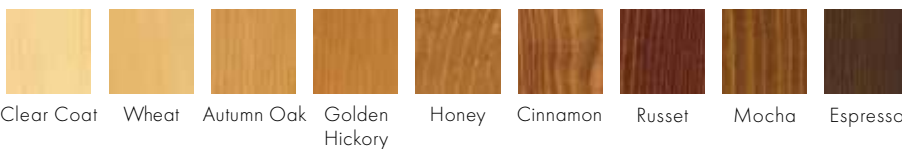

Interior custom stains, paints and color matching available.

#### INTERIOR PAINTED OPTIONS



\*Actual wood species is either Sapele or Sipo, both non-endangered species grown in Africa, with color and characteristics similar to Central American mahoganies.

\*\*Visit andersenwindows.com/warranty for details.

Printing limitations prevent exact replication of colors and finishes. Please see your Andersen supplier for actual color and finish samples.

**ACCESSORIES** Sold Separately

**AWNING WINDOWS**

**HARDWARE**

**Power Operator**



Power operators are available in bronze, white, black or gold.

**Window Opening Control Device Kit**

An optional Window Opening Control Device Kit is available, which limits opening the sash to less than 4" when the window is first opened. Available in stone and white.

**Construction Hardware**



Construction locks and operator handles keep your permanent window hardware away from the construction process and possible damage yet allow operation of windows during construction.

**SENSORS**

**VeriLock® Security Sensors**

VeriLock sensors are unique as they detect whether the windows are locked or unlocked\* — a feature no other sensors can provide. See page 27 for Smart Home options.

**Open/Closed Sensors**

Wireless open/closed sensors are available in four colors. See page 27 for details.

**PRIVACY OPTIONS**

**System 3 Blinds**



A 5/8" aluminum slat blind is mounted to an extruded aluminum blind panel and applied to the window, creating a triple-glazed window boasting privacy and energy efficiency. Available in three colors. Blind panels are offered in white, tan, gold or an optional wood veneer to match your interior.

**System 3 Shades**

Pleated fabric shades are available in four colors to effortlessly and beautifully filter the light. See page 25 for more details.

**INSECT SCREENS**

**Conventional Insect Screens**



Charcoal fiberglass screen mesh fits into an aluminum frame in colors of bronze, white or gold as well as optional black. Aluminum screen mesh and wood-veneered insect screen also available as options.

**TruScene® Insect Screens**



TruScene insect screens available in painted aluminum or wood-veneered options.

**Retractable Insect Screens**

Retractable insect screen available in wood-veneered options.

See page 24 for more information on our insect screen options.

**GRILLES**

**Full Divided Light**

Permanent interior and exterior grilles with grille spacer bars between two panes of glass. Available in 5/8", 7/8", 1 1/8", 1 1/2", or 2 1/4" widths. Interior grilles are available with ovolo or contemporary profile (ovolo profile shown below). Not all widths are shown.



5/8"

7/8"



1 1/8"

1 1/2"

**Simulated Divided Light**

Permanent exterior and interior grilles without grille spacer bars. Available in 5/8", 7/8", 1 1/8", 1 1/2", or 2 1/4" widths. Interior grilles are available with ovolo or contemporary profile (ovolo profile shown below). Not all widths are shown.



7/8"

**Finelight™ Grilles-Between-the-Glass**

Available in 5/8" flat or 1" contoured aluminum profiles. Two-tone colors of pebble tan/colony white, sierra bronze/colony white or forest green/colony white are available on the 1" profile.



5/8" Flat

1" Contoured

**Removable Interior Wood Grilles**

Removable interior wood grilles are available in a 7/8" width and ovolo or contemporary profiles. Optional surround for removable grille and permanent exterior grilles also available.



7/8"

See page 22 for more information on grilles.

\*When properly configured and maintained with a professionally installed security system and/or self monitoring system compatible with Honeywell® 5800 controls. See your Andersen supplier for more information.

# PUSH OUT AWNING WINDOW

## FEATURES

### PUSH OUT AWNING WINDOWS

#### FRAME & SASH

**A** Select wood components are kiln dried and treated with water/insect repellent and preservative. Interior wood surfaces are available in pine, mixed grain Douglas fir, cherry, hickory, mahogany\*, maple, oak, walnut, alder or vertical grain Douglas fir. Interior surfaces are available unfinished or factory primed. Factory-applied finishes are available in a variety of stain and paint options.

**B** Wood components are fitted with aluminum extrusions on the exterior. 50 exterior colors that meet AAMA 2604 and 2605 specifications are available, as well as custom colors. Also available is a selection of seven exterior anodized options.

Vinyl installation flanges are pre-applied into a kerf on the frame exterior to facilitate installation. Optional aluminum flanges and metal installation clips are available.

**C** A Fibrex® material thermal barrier encompasses the interior perimeter of the frame and is a neutral beige color.

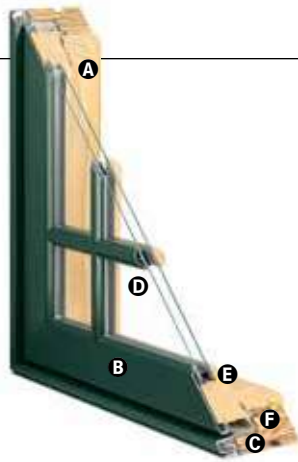

**D** A continuous perimeter bulb weatherstrip around the frame is positioned on the Fibrex material thermal barrier and provides solid surface contact with the sash.

A secondary bulb weatherstrip is applied on three sides of the sash. Available in white or optional black.

#### GLASS

**E** High-Performance Low-E4® glass with a low-conductivity spacer. Triple-pane glass, tinted, clear dual-pane, high-altitude glass and other special glazing options are available.

**F** Glass is fixed in place from the interior with wood stops that can be removed for easy reglazing if necessary. Glass stops available in ovolo (colonial) and contemporary profiles.

#### HARDWARE

Manual lock system featuring lock handles allows for easy operation. Units under 40" high use a single lock, while units 40" and taller use dual locks. Lock handles are available in six finishes.

Equipped with a stainless steel 4-bar friction hinge.

#### HARDWARE OPTIONS



Antique Brass | Black  
Oil Rubbed Bronze  
Polished Brass  
**Satin Chrome** | White

Bold name denotes finish shown.

#### HARDWARE FINISHES



Antique Brass    Black    Oil Rubbed Bronze    Polished Brass    Satin Chrome    White

Oil rubbed bronze is a "living" finish that will change with time and use.

## EXTERIOR & INTERIOR OPTIONS

**EXTERIOR COLORS** 50 exterior colors, 7 anodized finishes and custom colors. See exterior colors on page 11.

#### INTERIOR WOOD SPECIES

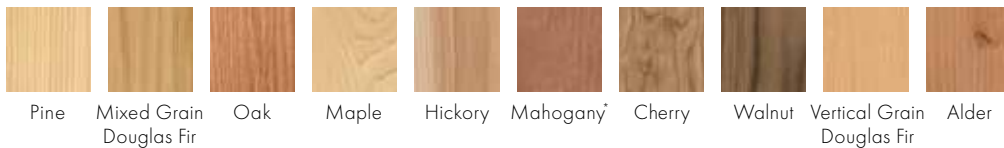

Naturally occurring variations in grain, color and texture of wood make each window one of a kind.

All factory-finished options are shown on pine.

Painted options available on pine. Dark bronze and black painted options available on pine or maple.

Anodized silver painted option available on maple only.

Interior custom stains, paints and color matching available.

#### FACTORY-FINISHED INTERIORS

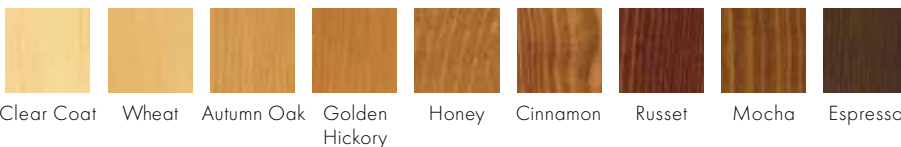

#### INTERIOR PAINTED OPTIONS

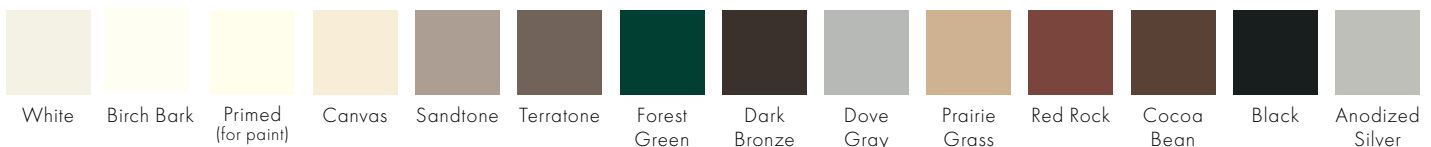

\*Actual wood species is either Sapele or Sipo, both non-endangered species grown in Africa, with color and characteristics similar to Central American mahoganies. Printing limitations prevent exact replication of colors and finishes. Please see your Andersen supplier for actual color and finish samples.

**ACCESSORIES** Sold Separately

**PUSH OUT AWNING WINDOWS**

**SENSORS**

**VeriLock® Security Sensors**

VeriLock sensors are unique as they detect whether the windows are locked or unlocked\* — a feature no other sensors can provide. See page 27 for Smart Home options.

**INSECT SCREENS**

**Hinged Insect Screens**



Oil Rubbed Bronze\*\*

Hinged insect screen opens to the interior, providing access to the lock handle. Choose from charcoal fiberglass or aluminum screen mesh. Available in wood-veneered options. Insect screen pulls are available in antique brass, black, oil rubbed bronze,\*\* polished brass, satin chrome and white.

**Retractable Insect Screens**

Retractable insect screen available in wood-veneered options. Extension jambs required for push out awning windows with retractable insect screens.

See page 24 for more information on our insect screen options.

**GRILLES**

**Full Divided Light**

Permanent interior and exterior grilles with grille spacer bars between two panes of glass. Available in 5/8", 7/8", 1 1/8", 1 1/2", or 2 1/4" widths. Interior grilles are available with ovolo or contemporary profile (ovolo profile shown below). Not all widths are shown.

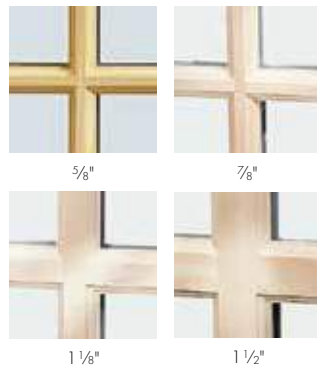

**Simulated Divided Light**

Permanent exterior and interior grilles without grille spacer bars. Available in 5/8", 7/8", 1 1/8", 1 1/2", or 2 1/4" widths. Interior grilles are available with ovolo or contemporary profile (ovolo profile shown below). Not all widths are shown.



**Finelight™ Grilles-Between-the-Glass**

Available in 5/8" flat or 1" contoured aluminum profiles. Two-tone colors of pebble tan/colony white, sierra bronze/colony white or forest green/colony white are available on the 1" profile.



**Removable Interior Wood Grilles**

Removable interior wood grilles are available in a 7/8" width and ovolo or contemporary profiles. Optional surround for removable grille and permanent exterior grilles also available.



See page 22 for more information on grilles.

\*When properly configured and maintained with a professionally installed security system and/or self monitoring system compatible with Honeywell® 5800 controls. See your Andersen supplier for more information.

\*\*Oil rubbed bronze is a "living" finish that will change with time and use.

# AWNING WINDOWS

## Awning Window Sizes

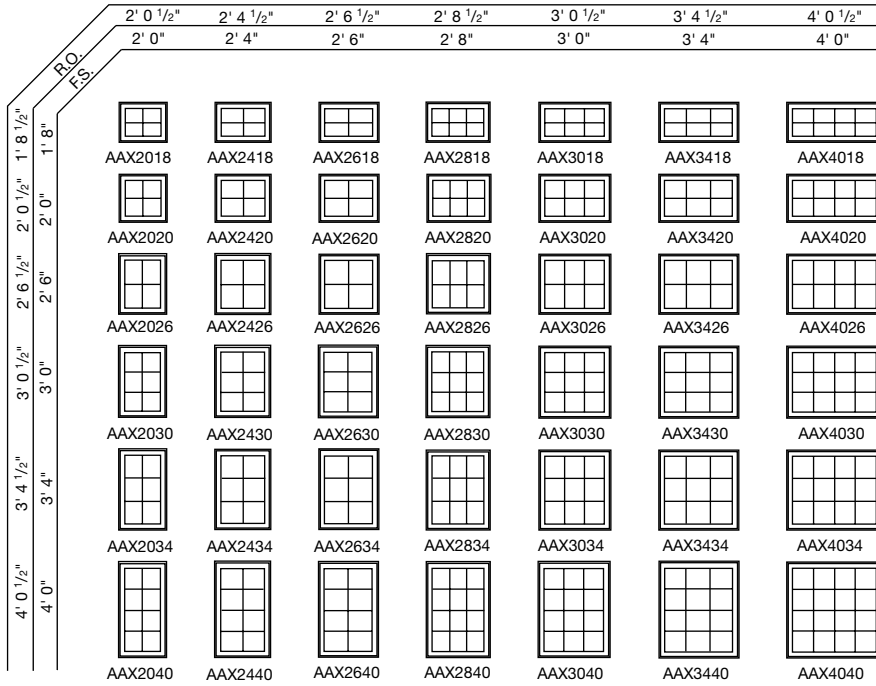

### NOTES

If glass is positioned within 18" of the finished floor, safety/tempered glass may be required. Local codes may differ. Verify tempered glass requirements with your local building code official.

Use structural joining material when necessary or required by code.

The light patterns illustrated apply to rectangular removable interior wood grilles, Full Divided Light, Simulated Divided Light, Decorelle 100, 150 and 400 and Finelight™ Grilles-Between-the-Glass. All removable interior wood grilles will be installed in the units unless otherwise specified.

For a metric conversion in millimeters, multiply dimensions in inches by 25.4.

Vent Layout as Viewed From Exterior

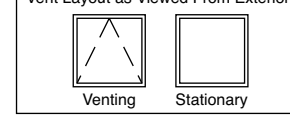

### FORMULA FOR COMBINATION WINDOWS

The overall frame dimension (both width and height) is equal to the sum of the individual unit frame dimensions plus joining material dimension(s).

The overall rough opening (both width and height) is equal to the overall frame dimensions plus 1/4" on all sides.

Any unit within each combination can be operating or stationary.

### PUSH OUT AWNING

Units ≥ 36" Actual Frame Height receive (2) friction stays.

## Push Out Awning Window Sizes

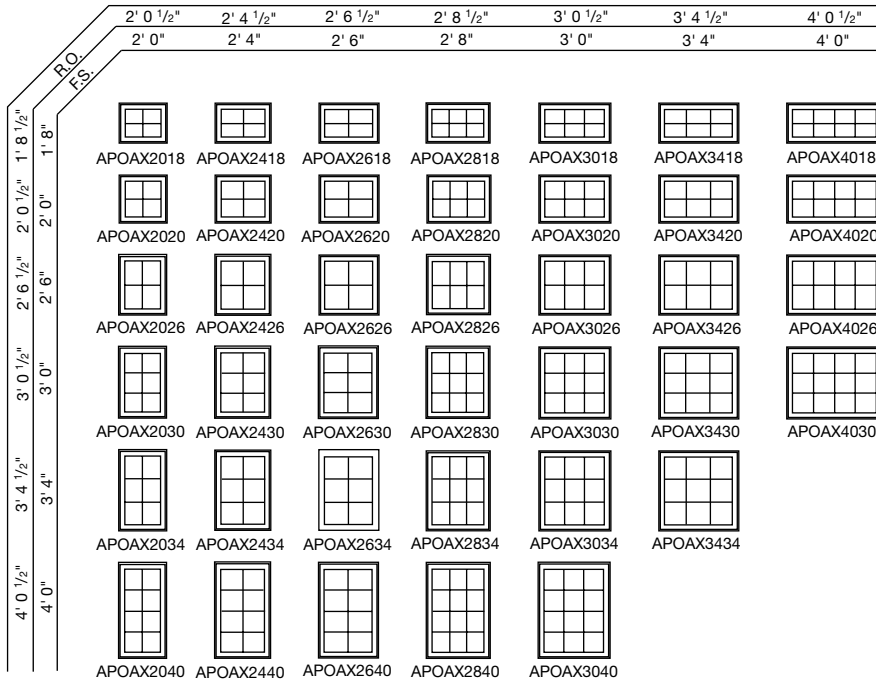

FOR WINDOWS GREATER THAN 30 SQUARE FEET OR RATED HIGHER THAN PG50, ONE OF THESE THREE INSTALLATION METHODS IS REQUIRED:  
 A) THROUGH THE JAMB B) ALUMINUM INSTALLATION FLANGE OR C) INSTALLATION CLIPS.  
 ADDITIONAL CUSTOM SIZES ARE AVAILABLE. CONTACT YOUR LOCAL SUPPLIER FOR MORE INFORMATION. DRAWINGS ARE NOT TO SCALE.



**Awning Windows**

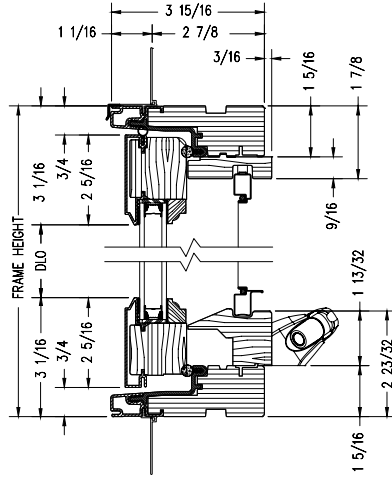

Vertical Section

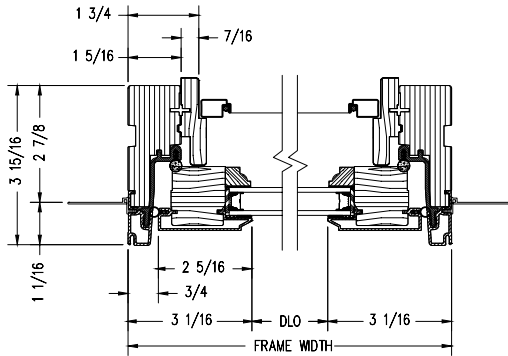

Horizontal Section

Shown with ovolo (colonial) glass stops.

**Push Out Awning Windows**

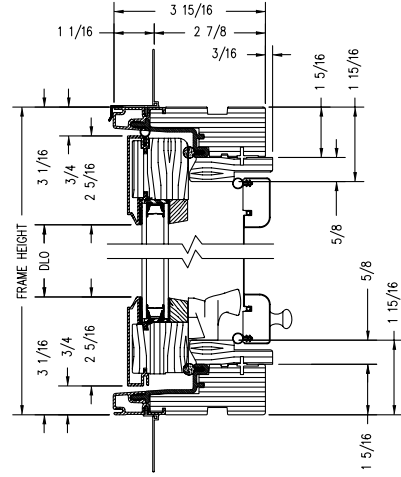

Vertical Section

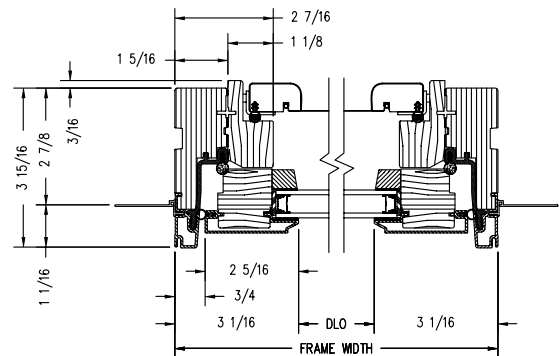

Horizontal Section

Shown with contemporary glass stops.

Joined Awning Width Combinations	2-Wide		3-Wide		
	Single Unit Frame Width	Rough Opening Width	Frame Width	Rough Opening Width	Frame Width
	2'-0"	4'-0 1/2"	4'-0"	6'-0 1/2"	6'-0"
	2'-4"	4'-8 1/2"	4'-8"	7'-0 1/2"	7'-0"
	2'-6"	5'-0 1/2"	5'-0"	7'-6 1/2"	7'-6"
	2'-8"	5'-4 1/2"	5'-4"	8'-0 1/2"	8'-0"
	3'-0"	6'-0 1/2"	6'-0"	9'-0 1/2"	9'-0"
	3'-4"	6'-8 1/2"	6'-8"	10'-0 1/2"	10'-0"
	4'-0"	8'-0 1/2"	8'-0"	12'-0 1/2"	12'-0"

Joined Awning Height Combinations	2-High		3-High		
	Single Unit Frame Height	Rough Opening Height	Frame Height	Rough Opening Height	Frame Height
	1'-8"	3'-4 1/2"	3'-4"	5'-0 1/2"	5'-0"
	2'-0"	4'-0 1/2"	4'-0"	6'-0 1/2"	6'-0"
	2'-6"	5'-0 1/2"	5'-0"	7'-6 1/2"	7'-6"
	3'-0"	6'-0 1/2"	6'-0"	9'-0 1/2"	9'-0"
	3'-4"	6'-8 1/2"	6'-8"	10'-0 1/2"	10'-0"
	4'-0"	8'-0 1/2"	8'-0"	12'-0 1/2"	12'-0"

PROPER INSTALLATION AND MAINTENANCE OF E-SERIES PRODUCTS IS ESSENTIAL TO ATTAIN OPTIMUM PERFORMANCE AND OPERATION. WRITTEN INSTALLATION INSTRUCTIONS THAT PROVIDE GUIDELINES FOR PROPER INSTALLATION ARE AVAILABLE BY VISITING [ANDERSENWINDOWS.COM](http://ANDERSENWINDOWS.COM). CUSTOM SIZES ARE AVAILABLE. CONTACT YOUR LOCAL SUPPLIER FOR MORE INFORMATION. DRAWINGS ARE NOT TO SCALE.

E-Series Awning Windows

# DOUBLE-HUNG WINDOWS

A classic beauty, double-hung windows offer a sleek design with ventilation options from the top, bottom or both. Add a TruScene® insect screen to let the outside in, maximizing your view, not limiting it. E-Series double-hung windows give you the option to select aluminum or wood jamb liner inserts for added visual appeal and include flush-mounted hardware that allows for easy tilt-in operation.

---

<b>Double-Hung Overview</b> .....	<b>58</b>
<b>Double-Hung Insert Overview</b> .....	<b>60</b>
<b>Double-Hung Sash Replacement Kit Overview</b> .....	<b>62</b>
Sizing	
Double-Hung .....	64
Double-Hung Cottage & Reverse Cottage .....	66
Double-Hung Picture & Transom .....	67
Arch Single-Hung .....	68
Arch Single-Hung Reverse Cottage .....	70
Direct-Set Double-Hung Transom .....	71
Monumental Single-Hung .....	72
Details .....	74
Installation Materials .....	154
Product Performance .....	158





# DOUBLE-HUNG WINDOW

## FEATURES

### DOUBLE-HUNG WINDOWS

#### FRAME & SASH

**A** Select wood components are kiln dried and treated with water/insect repellent and preservative. Interior wood surfaces are available in pine, mixed grain Douglas fir, cherry, hickory, mahogany\*, maple, oak, walnut, alder or vertical grain Douglas fir. Interior surfaces are available unfinished or factory primed. Factory-applied finishes are available in a variety of stain and paint options.

**B** Wood components are fitted with aluminum extrusions on the exterior. 50 exterior colors that meet AAMA 2604 and 2605 specifications are available, as well as custom colors. Also available is a selection of seven exterior anodized options.

Optional vinyl installation flanges are pre-applied into a kerf on the frame exterior to facilitate installation. Optional aluminum flanges or metal installation clips are available.

**C** Compression bulb weatherstrip is applied on the bottom sash, head jamb, at the meeting rail and on side jambs for a maximum weather seal.

Jamb liners encase balancer assemblies that allow each sash to be tilted 90° inward from a bottom pivot and stay securely in place for washing.

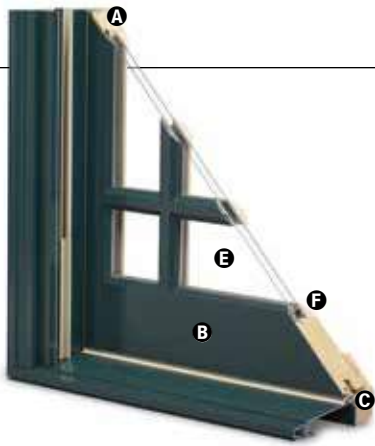

**D** Double-hung jamb liners incorporate synthetic interior and exterior inserts or optional painted aluminum exterior and wood-veneered interior inserts.

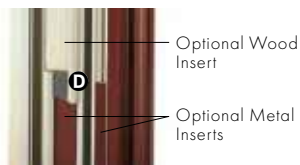

#### GLASS

**E** High-Performance Low-E4® glass with a low-conductivity spacer. Triple-pane glass, tinted, clear dual-pane, high-altitude glass and other special glazing options are available.

**F** Glass is fixed in place from the interior with wood stops that can be removed for easy reglazing if necessary. Glass stops available in ovolo (colonial) and contemporary profiles.

#### HARDWARE

Sash lock/tilt mechanisms and keepers give a slim, more traditional design and allow opening and tilting of the window in one operation. Tilting the sash from the inside for cleaning is effortless.

Optional surface mount sash lifts allow for easy operation. Units less than 3' wide use one lift. Units 3' wide and greater use two lifts.

#### HARDWARE OPTIONS



Lock



Sash Lift

Antique Brass | **Black** | Bright Chrome | Bronze | Gold  
Oil Rubbed Bronze | Pewter | Polished Brass | Satin Chrome | White

Windows with VeriLock® sensors use a different sash lock. See the next page for details.

#### HARDWARE FINISHES



Antique Brass | Black | Bright Chrome | Bronze | Gold  
Oil Rubbed Bronze | Pewter | Polished Brass | Satin Chrome | White

Oil rubbed bronze is a "living" finish that will change with time and use.

## EXTERIOR & INTERIOR OPTIONS

**EXTERIOR COLORS** 50 exterior colors, 7 anodized finishes and custom colors. See exterior colors on page 11.

#### INTERIOR WOOD SPECIES

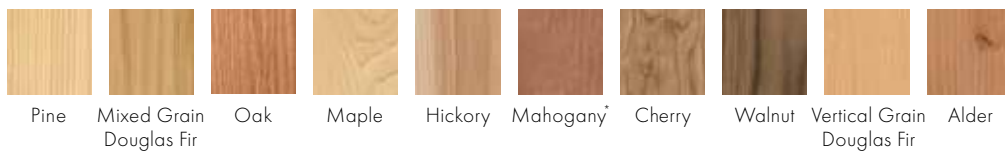

Pine | Mixed Grain Douglas Fir | Oak | Maple | Hickory | Mahogany\* | Cherry | Walnut | Vertical Grain Douglas Fir | Alder

#### FACTORY-FINISHED INTERIORS



Clear Coat | Wheat | Autumn Oak | Golden Hickory | Honey | Cinnamon | Russet | Mocha | Espresso

#### INTERIOR PAINTED OPTIONS

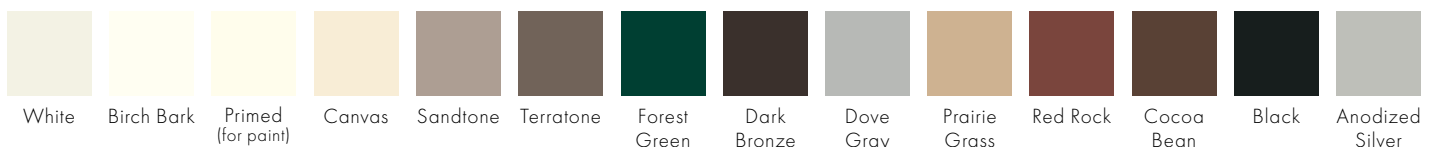

White | Birch Bark | Primed (for paint) | Canvas | Sandtone | Terratone | Forest Green | Dark Bronze | Dove Gray | Prairie Grass | Red Rock | Cocoa Bean | Black | Anodized Silver

Naturally occurring variations in grain, color and texture of wood make each window one of a kind.

All factory-finished options are shown on pine.

Painted options available on pine. Dark bronze and black painted options available on pine or maple. Anodized silver painted option available on maple only.

Interior custom stains, paints and color matching available.

\*Actual wood species is either Sapele or Sipo, both non-endangered species grown in Africa, with color and characteristics similar to Central American mahoganies. Printing limitations prevent exact replication of colors and finishes. Please see your Andersen supplier for actual color and finish samples.

**ACCESSORIES** Sold Separately

**DOUBLE-HUNG WINDOWS**
**HARDWARE**
**Window Opening Control Device Kit**

An optional Window Opening Control Device Kit is available, which limits opening the sash to less than 4" when the window is first opened. Available in stone and white.

**SENSORS**
**VeriLock® Security Sensors**

VeriLock sensors are unique as they detect whether the windows are locked or unlocked\* — a feature no other sensors can provide. See page 27 for Smart Home options.

**Open/Closed Sensors**

Wireless open/closed sensors are available in four colors. See page 27 for details.

**INSECT SCREENS**
**Conventional Insect Screens**

Charcoal fiberglass screen mesh fits into an aluminum frame in all 50 exterior colors and seven anodized finishes. Available in half or full insect screens. Aluminum screen mesh is available as an option.

**TruScene® Insect Screens**

TruScene insect screens available in all 50 exterior colors and seven anodized finishes.

See page 24 for more information on our insect screen options.

**GRILLES**
**Full Divided Light**

Permanent interior and exterior grilles with grille spacer bars between two panes of glass. Available in 5/8", 7/8", 1 1/8", 1 1/2", or 2 1/4" widths. Interior grilles are available with ovolo or contemporary profile (ovolo profile shown below). Not all widths are shown.



5/8"

7/8"



1 1/8"

1 1/2"

**Simulated Divided Light**

Permanent exterior and interior grilles without grille spacer bars. Available in 5/8", 7/8", 1 1/8", 1 1/2", or 2 1/4" widths. Interior grilles are available with ovolo or contemporary profile (ovolo profile shown below). Not all widths are shown.



7/8"

**Finelight™**
**Grilles-Between-the-Glass**

Available in 5/8" flat or 1" contoured aluminum profiles. Two-tone colors of pebble tan/colony white, sierra bronze/colony white or forest green/colony white are available on the 1" profile.



5/8" Flat

1" Contoured

**Removable Interior Wood Grilles**

Removable interior wood grilles are available in a 7/8" width and ovolo or contemporary profiles. Optional surround for removable grille and permanent exterior grilles also available.



7/8"

See page 22 for more information on grilles.

\*When properly configured and maintained with a professionally installed security system and/or self monitoring system compatible with Honeywell® 5800 controls. See your Andersen supplier for more information.

# DOUBLE-HUNG INSERT WINDOW

## FEATURES

### DOUBLE-HUNG INSERT WINDOWS

Double-hung insert window fits into an existing window frame making installation a breeze. The appearance of the interior and exterior of the home are maintained because the existing frame, wall coverings and trim work stay completely intact.

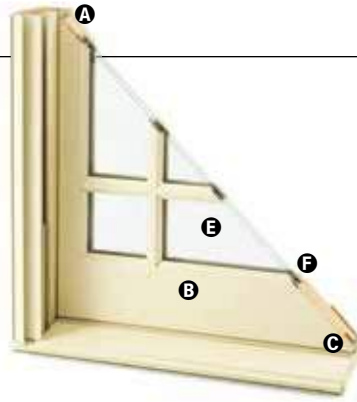

### FRAME & SASH

**A** Select wood components are kiln dried and treated with water/insect repellent and preservative. Interior wood surfaces are available in pine, mixed grain Douglas fir, cherry, hickory, mahogany\*, maple, oak, walnut, alder or vertical grain Douglas fir. Interior surfaces are available unfinished or factory primed. Factory-applied finishes are available in a variety of stain and paint options.

**B** Wood components are fitted with aluminum extrusions on the exterior. 50 exterior colors that meet AAMA 2604 and 2605 specifications are available, as well as custom colors. Also available is a selection of seven exterior anodized options.

**C** Compression bulb weatherstrip is applied on the bottom sash, head jamb, at the meeting rail and on side jambs for a maximum weather seal.

Jamb liners encase balancer assemblies that allow each sash to be tilted 90° inward from a bottom pivot and stay securely in place for washing.

**D** Basic jamb liners are available in beige or white and are made of synthetic material. Optional painted aluminum exterior inserts and wood-veneered interior inserts also available.

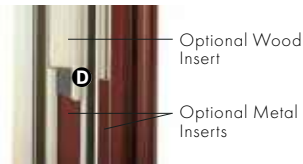

### SILL

8 degrees is the standard slope. Filler block is used on existing window sill angles of less than 8 degrees.

### GLASS

**E** High-Performance Low-E4® glass with a low-conductivity spacer. Triple-pane glass, tinted, clear dual-pane, high-altitude glass and other special glazing options are available.

**F** Glass is fixed in place from the interior with wood stops that can be removed for easy reglazing if necessary. Glass stops available in ovolo (colonial) and contemporary profiles.

## HARDWARE OPTIONS



Lock



Sash Lift

Antique Brass | **Black** | Bright Chrome | Bronze | Gold  
Oil Rubbed Bronze | Pewter | Polished Brass | Satin Chrome | White

Windows with VeriLock® sensors use a different sash lock. See the next page for details.  
Bold name denotes finish shown.

### HARDWARE FINISHES



Oil rubbed bronze is a "living" finish that will change with time and use.

## EXTERIOR & INTERIOR OPTIONS

**EXTERIOR COLORS** 50 exterior colors, 7 anodized finishes and custom colors. See exterior colors on page 11.

### INTERIOR WOOD SPECIES

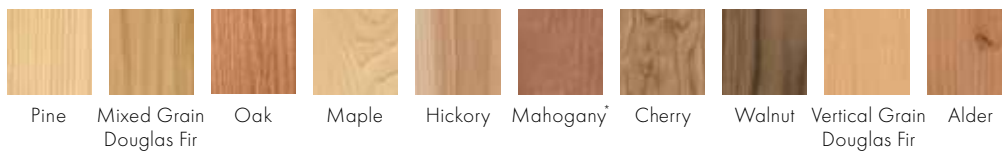

Naturally occurring variations in grain, color and texture of wood make each window one of a kind.

All factory-finished options are shown on pine.

Painted options available on pine. Dark bronze and black painted options available on pine or maple. Anodized silver painted option available on maple only.

Interior custom stains, paints and color matching available.

### FACTORY-FINISHED INTERIORS



### INTERIOR PAINTED OPTIONS

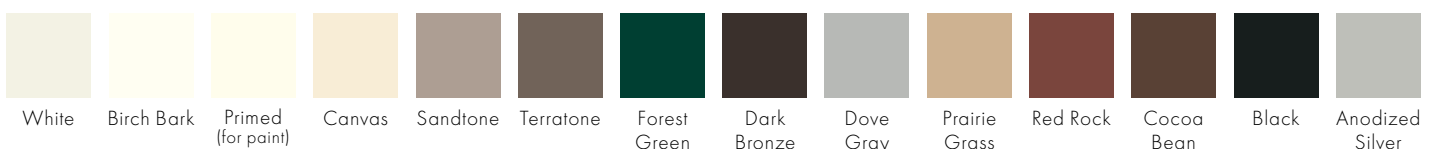

\*Actual wood species is either Sapele or Sipo, both non-endangered species grown in Africa, with color and characteristics similar to Central American mahoganies. Printing limitations prevent exact replication of colors and finishes. Please see your Andersen supplier for actual color and finish samples.

**HARDWARE**

Sash lock/tilt mechanisms and keepers give a slim, more traditional design and allow opening and tilting of the window in one operation. Tilting the sash from the inside for cleaning is effortless.

Surface mount sash lifts allow for easy operation. Units less than 3' wide use one lift. Units 3' wide and greater use two lifts.

**MEASURING GUIDELINES**

Measuring guidelines for double-hung insert and picture insert windows can be found on [andersenwindows.com/measure](http://andersenwindows.com/measure).

**ACCESSORIES** Sold Separately

**DOUBLE-HUNG INSERT WINDOWS**

**HARDWARE**

**Window Opening Control Device Kit**

An optional Window Opening Control Device Kit is available, which limits opening the sash to less than 4" when the window is first opened. Available in stone and white.

**SENSORS**

**VeriLock® Security Sensors**



VeriLock sensors are unique as they detect whether the windows are locked or unlocked\* — a feature no other sensors can provide. See page 27 for Smart Home options.

**Open/Closed Sensors**

Wireless open/closed sensors are available in four colors. See page 27 for details.

**INSECT SCREENS**

**Conventional Insect Screens**



Charcoal fiberglass screen mesh fits into an aluminum frame in all 50 exterior colors and seven anodized finishes. Available in half or full insect screens. Aluminum screen mesh is available as an option.

**TruScene® Insect Screens**

TruScene insect screens available in all 50 exterior colors and seven anodized finishes.

See page 24 for more information on our insect screen options.

**GRILLES**

**Full Divided Light**

Permanent interior and exterior grilles with grille spacer bars between two panes of glass. Available in 5/8", 7/8", 1 1/8", 1 1/2", or 2 1/4" widths. Interior grilles are available with ovolo or contemporary profile (ovolo profile shown below). Not all widths are shown.



5/8"

7/8"



1 1/8"

1 1/2"

**Simulated Divided Light**

Permanent exterior and interior grilles without grille spacer bars. Available in 5/8", 7/8", 1 1/8", 1 1/2", or 2 1/4" widths. Interior grilles are available with ovolo or contemporary profile (ovolo profile shown below). Not all widths are shown.



7/8"

**Finelight™ Grilles-Between-the-Glass**

Available in 5/8" flat or 1" contoured aluminum profiles. Two-tone colors of pebble tan/colony white, sierra bronze/colony white or forest green/colony white are available on the 1" profile.



5/8" Flat

1" Contoured

**Removable Interior Wood Grilles**

Removable interior wood grilles are available in a 7/8" width and ovolo or contemporary profiles. Optional surround for removable grille and permanent exterior grilles also available.



7/8"

See page 22 for more information on grilles.

\*When properly configured and maintained with a professionally installed security system and/or self monitoring system compatible with Honeywell® 5800 controls. See your Andersen supplier for more information.

# DOUBLE-HUNG SASH REPLACEMENT KIT

## FEATURES

### DOUBLE-HUNG SASH REPLACEMENT KITS

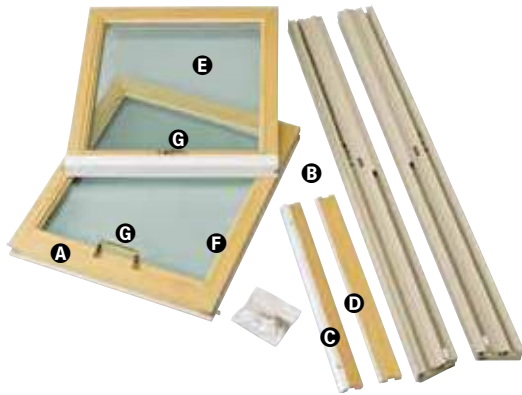

Double-hung sash replacement kits are complete with window sash, locking hardware and sash lifts, compression jamb liners and balancer systems, sill filler, head parting stop and installation hardware. Each kit is built to your exact measurements.

The kits were designed to replace older sash with a new energy-efficient sash without removing the trim and the window frame. The sash replacement will fit a double-hung window with a jamb pocket depth of 2 1/4" or larger.

Kits are also available in a picture window design. The sash depth is 1 7/32". Picture window sash replacement kit consists of one sash and one sill filler.

#### SASH

**A** Select wood components are kiln dried and treated with water/insect repellent and preservative. Interior wood surfaces are available in pine, mixed grain Douglas fir, cherry, hickory, mahogany\*, maple, oak, walnut, alder or vertical grain Douglas fir. Interior surfaces are available unfinished or factory primed. Factory-applied finishes are available in a variety of stain and paint options.

**B** Wood components are fitted with aluminum extrusions on the exterior. 50 exterior colors that meet AAMA 2604 and 2605 specifications are available, as well as custom colors. Also available is a selection of seven exterior anodized options.

**C** The sash replacement kit utilizes a two-piece foam weatherstrip on the bottom of the lower sash that forms a weather-tight seal against the sill filler when closed.

**D** Hollow bulb weatherstrip forms a compression seal at the meeting rails and at the head.

Each kit utilizes a two-piece foam-backed jamb liner and a block and tackle balancer system. The sash tilt inward for easy cleaning. Beige or white jamb liners are available and are cut to the sill slope specified at time of order.

## HARDWARE OPTIONS



Lock



Sash Lift

Bronze | Polished Brass | Gold | White | **Black**

Bold name denotes finish shown.

#### HARDWARE FINISHES



Oil rubbed bronze is a "living" finish that will change with time and use.

## EXTERIOR & INTERIOR OPTIONS

**EXTERIOR COLORS** 50 exterior colors, 7 anodized finishes and custom colors. See exterior colors on page 11.

#### INTERIOR WOOD SPECIES

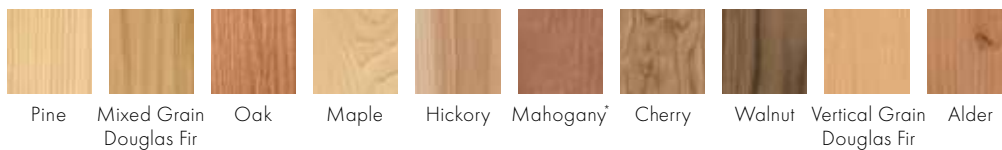

Naturally occurring variations in grain, color and texture of wood make each window one of a kind.

All factory-finished options are shown on pine.

Painted options available on pine. Dark bronze and black painted options available on pine or maple.

Anodized silver painted option available on maple only.

Interior custom stains, paints and color matching available.

#### FACTORY-FINISHED INTERIORS

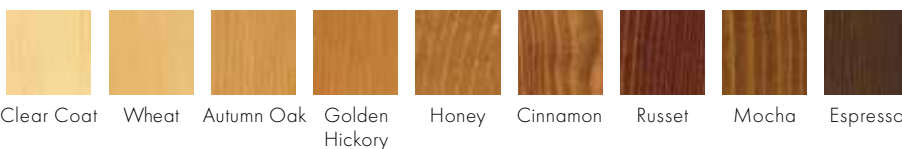

#### INTERIOR PAINTED OPTIONS

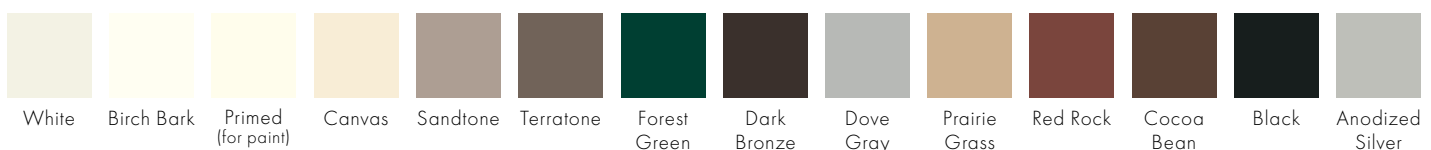

\*Actual wood species is either Sapele or Sipo, both non-endangered species grown in Africa, with color and characteristics similar to Central American mahoganies. Printing limitations prevent exact replication of colors and finishes. Please see your Andersen supplier for actual color and finish samples.



**GLASS**

**E** High-Performance Low-E4® glass with a low-conductivity spacer. Triple-pane glass, tinted, clear dual-pane, high-altitude glass and other special glazing options are available.

**F** Glass is fixed in place from the interior with wood stops that can be removed for easy reglazing if necessary. Glass stops available in ovolo (colonial) and contemporary profiles.

**HARDWARE**

**G** Sash replacement kits under 36" in width will receive one lock and one sash lift. Kits 36" to 48" in width will receive two locks and two sash lifts. Kits 48" and wider will require three locks and two sash lifts.

**MEASURING GUIDELINES**

Measuring guidelines for double-hung and picture sash replacement kits can be found on [andersenwindows.com/measure](http://andersenwindows.com/measure).

**ACCESSORIES** Sold Separately

**DOUBLE-HUNG SASH REPLACEMENT KITS**

**INSECT SCREENS**

**Conventional Insect Screens**



Charcoal fiberglass screen mesh fits into an aluminum frame in all 50 exterior colors and seven anodized finishes. Available in half or full insect screens. Aluminum screen mesh is available as an option.

**TruScene® Insect Screens**

TruScene insect screens available in all 50 exterior colors and seven anodized finishes.

See page 24 for more information on our insect screen options.

**GRILLES**

**Full Divided Light**

Permanent interior and exterior grilles with grille spacer bars between two panes of glass. Available in 5/8", 7/8", 1 1/8", 1 1/2", or 2 1/4" widths. Interior grilles are available with ovolo or contemporary profile (ovolo profile shown below). Not all widths are shown.



**Simulated Divided Light**

Permanent exterior and interior grilles without grille spacer bars. Available in 5/8", 7/8", 1 1/8", 1 1/2", or 2 1/4" widths. Interior grilles are available with ovolo or contemporary profile (ovolo profile shown below). Not all widths are shown.



**Finelight™**

**Grilles-Between-the-Glass**

Available in 5/8" flat or 1" contoured aluminum profiles. Two-tone colors of pebble tan/colony white, sierra bronze/colony white or forest green/colony white are available on the 1" profile.



**Removable Interior Wood Grilles**

Removable interior wood grilles are available in a 7/8" width and ovolo or contemporary profiles. Optional surround for removable grille and permanent exterior grilles also available.



See page 22 for more information on grilles.

# DOUBLE-HUNG WINDOWS

## Double-Hung Window Sizes

	1' 8 1/2"	2' 0 1/2"	2' 4 1/2"	2' 6 1/2"	2' 8 1/2"	3' 0 1/2"	3' 2 1/2"	3' 4 1/2"	3' 8 1/2"	4' 0 1/2"
	1' 8"	2' 0"	2' 4"	2' 6"	2' 8"	3' 0"	3' 2"	3' 4"	3' 8"	4' 0"
3' 0 1/2"										
	TCLDH1830	TCLDH2030	TCLDH2430	TCLDH2630	TCLDH2830	TCLDH3030	TCLDH3230	TCLDH3430	TCLDH3830	
3' 4 1/2"										
	TCLDH1834	TCLDH2034	TCLDH2434	TCLDH2634	TCLDH2834	TCLDH3034	TCLDH3234	TCLDH3434	TCLDH3834	
4' 0 1/2"										
	TCLDH1840	TCLDH2040	TCLDH2440	TCLDH2640	TCLDH2840	TCLDH3040	TCLDH3240	TCLDH3440	TCLDH3840	TCLDH4040
4' 6 1/2"										
	TCLDH1846	TCLDH2046	TCLDH2446	TCLDH2646	TCLDH2846	TCLDH3046	TCLDH3246	TCLDH3446	TCLDH3846	TCLDH4046
4' 9 1/2"										
	TCLDH1849	TCLDH2049	TCLDH2449	TCLDH2649	TCLDH2849	TCLDH3049	TCLDH3249	TCLDH3449	TCLDH3849	TCLDH4049
5' 0 1/2"										
	TCLDH1850	TCLDH2050	TCLDH2450	TCLDH2650	TCLDH2850	TCLDH3050	TCLDH3250	TCLDH3450	TCLDH3850	TCLDH4050
5' 1 1/2"										
	TCLDH1851	TCLDH2051	TCLDH2451	TCLDH2651	TCLDH2851	TCLDH3051	TCLDH3251 †	TCLDH3451 †	TCLDH3851 †	TCLDH4051 †

Joined Double-Hung Combinations					
2-Wide			3-Wide		
Single Unit Frame Width	Rough Opening Width	Frame Width	Single Unit Frame Width	Rough Opening Width	Frame Width
1'-8"	3'-4 1/2"	3'-4"	1'-8"	5'-0 1/2"	5'-0"
2'-0"	4'-0 1/2"	4'-0"	2'-0"	6'-0 1/2"	6'-0"
2'-4"	4'-8 1/2"	4'-8"	2'-4"	7'-0 1/2"	7'-0"
2'-6"	5'-0 1/2"	5'-0"	2'-6"	7'-6 1/2"	7'-6"
2'-8"	5'-4 1/2"	5'-4"	2'-8"	8'-0 1/2"	8'-0"
3'-0"	6'-0 1/2"	6'-0"	3'-0"	9'-0 1/2"	9'-0"
3'-2"	6'-4 1/2"	6'-4"	3'-2"	9'-6 1/2"	9'-6"
3'-4"	6'-8 1/2"	6'-8"	3'-4"	10'-0 1/2"	10'-0"
3'-8"	7'-4 1/2"	7'-4"	3'-8"	11'-0 1/2"	11'-0"
4'-0"	8'-0 1/2"	8'-0"	4'-0"	12'-0 1/2"	12'-0"

### NOTES

† These units meet or exceed the following dimensions:  
 Clear Opening Area 5.7 sq. ft., Clear Opening Width 20",  
 Clear Opening Height 24" and 44" maximum floor to sill  
 height (with standard 6' 10-1/2" structural header height).  
 See your local code official for requirements in your area.

Units may be ordered with sash lifts if desired. Units 3' 0" and wider will use two sash lifts.

If glass is positioned within 18" of the finished floor, safety/tempered glass may be required. Local codes may differ. Verify tempered glass requirements with your local building code official.

Use structural joining material when necessary or required by code.

The light patterns illustrated apply to rectangular removable interior wood grilles, Full Divided Light, Simulated Divided Light, Decorelle 100, 150 and 400 and Finelight™ Grilles-Between-the-Glass. All removable interior wood grilles will be installed in the units unless otherwise specified.

For a metric conversion in millimeters, multiply dimensions in inches by 25.4.

### FORMULA FOR COMBINATION WINDOWS

The overall frame dimension (both width and height) is equal to the sum of the individual unit frame dimensions plus joining material dimension(s).

The overall rough opening (both width and height) is equal to the overall frame dimensions plus 1/4" on all sides.

**FOR WINDOWS GREATER THAN 30 SQUARE FEET OR RATED HIGHER THAN PG50, ONE OF THESE THREE INSTALLATION METHODS IS REQUIRED:  
 A) THROUGH THE JAMB B) ALUMINUM INSTALLATION FLANGE OR C) INSTALLATION CLIPS.  
 ADDITIONAL CUSTOM SIZES ARE AVAILABLE. CONTACT YOUR LOCAL SUPPLIER FOR MORE INFORMATION. DRAWINGS ARE NOT TO SCALE.**

**Double-Hung Window Sizes**

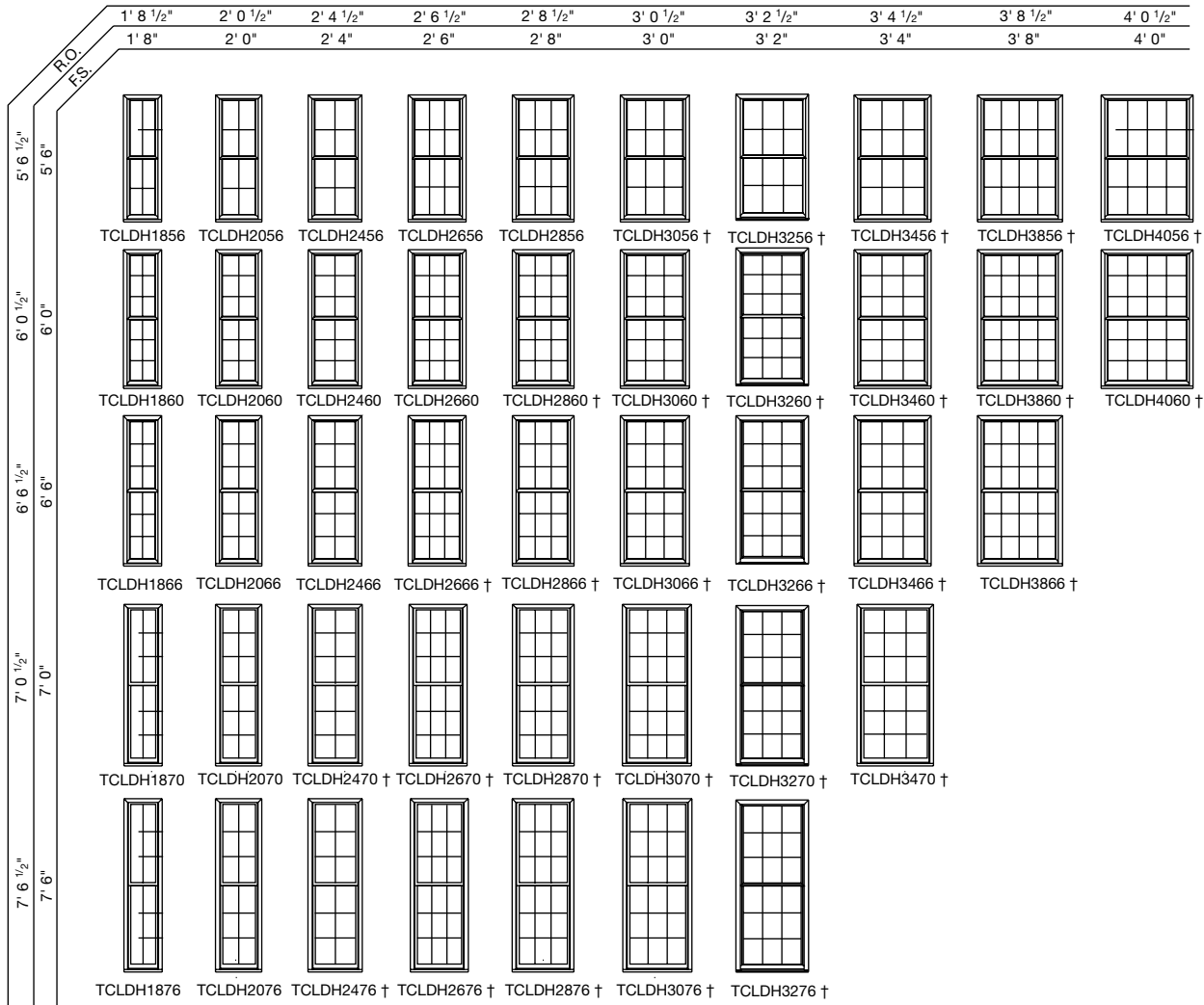

E-Series Double-Hung Windows

**NOTES**

† These units meet or exceed the following dimensions: Clear Opening Area 5.7 sq. ft., Clear Opening Width 20", Clear Opening Height 24" and 44" maximum floor to sill height (with standard 6' 10-1/2" structural header height). See your local code official for requirements in your area.

Units may be ordered with sash lifts if desired. Units 3'0" and wider will use two sash lifts.

If glass is positioned within 18" of the finished floor, safety/tempered glass may be required. Local codes may differ. Verify tempered glass requirements with your local building code official.

Use structural joining material when necessary or required by code.

The light patterns illustrated apply to rectangular removable interior wood grilles, Full Divided Light, Simulated Divided Light, Decorelle 100, 150 and 400 and Finelight™ Grilles-Between-the-Glass. All removable interior wood grilles will be installed in the units unless otherwise specified.

For a metric conversion in millimeters, multiply dimensions in inches by 25.4.

**FORMULA FOR COMBINATION WINDOWS**

The overall frame dimension (both width and height) is equal to the sum of the individual unit frame dimensions plus joining material dimension(s).

The overall rough opening (both width and height) is equal to the overall frame dimensions plus 1/4" on all sides.

**FOR WINDOWS GREATER THAN 30 SQUARE FEET OR RATED HIGHER THAN PG50, ONE OF THESE THREE INSTALLATION METHODS IS REQUIRED:  
A) THROUGH THE JAMB B) ALUMINUM INSTALLATION FLANGE OR C) INSTALLATION CLIPS.  
ADDITIONAL CUSTOM SIZES ARE AVAILABLE. CONTACT YOUR LOCAL SUPPLIER FOR MORE INFORMATION. DRAWINGS ARE NOT TO SCALE.**

# DOUBLE-HUNG WINDOWS

## Cottage & Reverse Cottage Double-Hung Window Sizes

	1' 8 1/2"	2' 0 1/2"	2' 4 1/2"	2' 6 1/2"	2' 8 1/2"	3' 0 1/2"	3' 2 1/2"	3' 4 1/2"	3' 8 1/2"
	1' 8"	2' 0"	2' 4"	2' 6"	2' 8"	3' 0"	3' 2"	3' 4"	3' 8"
4' 6 1/2"									
	TCLDH1846C	TCLDH2046C	TCLDH2446C	TCLDH2646C	TCLDH2846C	TCLDH3046C	TCLDH3246C	TCLDH3446C	TCLDH3846C
4' 6"									
	TCLDH1846RC	TCLDH2046RC	TCLDH2446RC	TCLDH2646RC	TCLDH2846RC	TCLDH3046RC	TCLDH3246RC	TCLDH3446RC	TCLDH3846RC
5' 0 1/2"									
	TCLDH1850C	TCLDH2050C	TCLDH2450C	TCLDH2650C	TCLDH2850C	TCLDH3050C	TCLDH3250C	TCLDH3450C	TCLDH3850C
5' 0"									
	TCLDH1850RC	TCLDH2050RC	TCLDH2450RC	TCLDH2650RC	TCLDH2850RC	TCLDH3050RC	TCLDH3250RC	TCLDH3450RC	TCLDH3850RC
5' 1 1/2"									
	TCLDH1851C	TCLDH2051C	TCLDH2451C	TCLDH2651C	TCLDH2851C	TCLDH3051C	TCLDH3251C	TCLDH3451C	TCLDH3851C
5' 1"									
	TCLDH1851RC	TCLDH2051RC	TCLDH2451RC	TCLDH2651RC	TCLDH2851RC	TCLDH3051RC	TCLDH3251RC	TCLDH3451RC	TCLDH3851RC
5' 6 1/2"									
	TCLDH1856C	TCLDH2056C	TCLDH2456C	TCLDH2656C	TCLDH2856C	TCLDH3056C	TCLDH3256C	TCLDH3456C	TCLDH3856C
5' 6"									
	TCLDH1856RC	TCLDH2056RC	TCLDH2456RC	TCLDH2656RC	TCLDH2856RC	TCLDH3056RC	TCLDH3256RC	TCLDH3456RC	TCLDH3856RC
6' 0 1/2"									
	TCLDH1860C	TCLDH2060C	TCLDH2460C	TCLDH2660C	TCLDH2860C	TCLDH3060C	TCLDH3260C	TCLDH3460C	TCLDH3860C
6' 0"									
	TCLDH1860RC	TCLDH2060RC	TCLDH2460RC	TCLDH2660RC	TCLDH2860RC	TCLDH3060RC	TCLDH3260RC	TCLDH3460RC	TCLDH3860RC

**NOTES**

Units may be ordered with sash lifts if desired. Units 3' 0" and wider will use two sash lifts.

If glass is positioned within 18" of the finished floor, safety/tempered glass may be required. Local codes may differ. Verify tempered glass requirements with your local building code official.

Use structural joining material when necessary or required by code.

The light patterns illustrated apply to rectangular removable interior wood grilles, Full Divided Light, Simulated Divided Light, Decorelle 100, 150 and 400 and Finelight™ Grilles-Between-the-Glass. All removable interior wood grilles will be installed in the units unless otherwise specified.

For a metric conversion in millimeters, multiply dimensions in inches by 25.4.

**FORMULA FOR COMBINATION WINDOWS**

The overall frame dimension (both width and height) is equal to the sum of the individual unit frame dimensions plus joining material dimension(s).

The overall rough opening (both width and height) is equal to the overall frame dimensions plus 1/4" on all sides.

**FOR WINDOWS GREATER THAN 30 SQUARE FEET OR RATED HIGHER THAN PG50, ONE OF THESE THREE INSTALLATION METHODS IS REQUIRED:  
A) THROUGH THE JAMB B) ALUMINUM INSTALLATION FLANGE OR C) INSTALLATION CLIPS.  
ADDITIONAL CUSTOM SIZES ARE AVAILABLE. CONTACT YOUR LOCAL SUPPLIER FOR MORE INFORMATION. DRAWINGS ARE NOT TO SCALE.**

### Double-Hung Picture Window Sizes

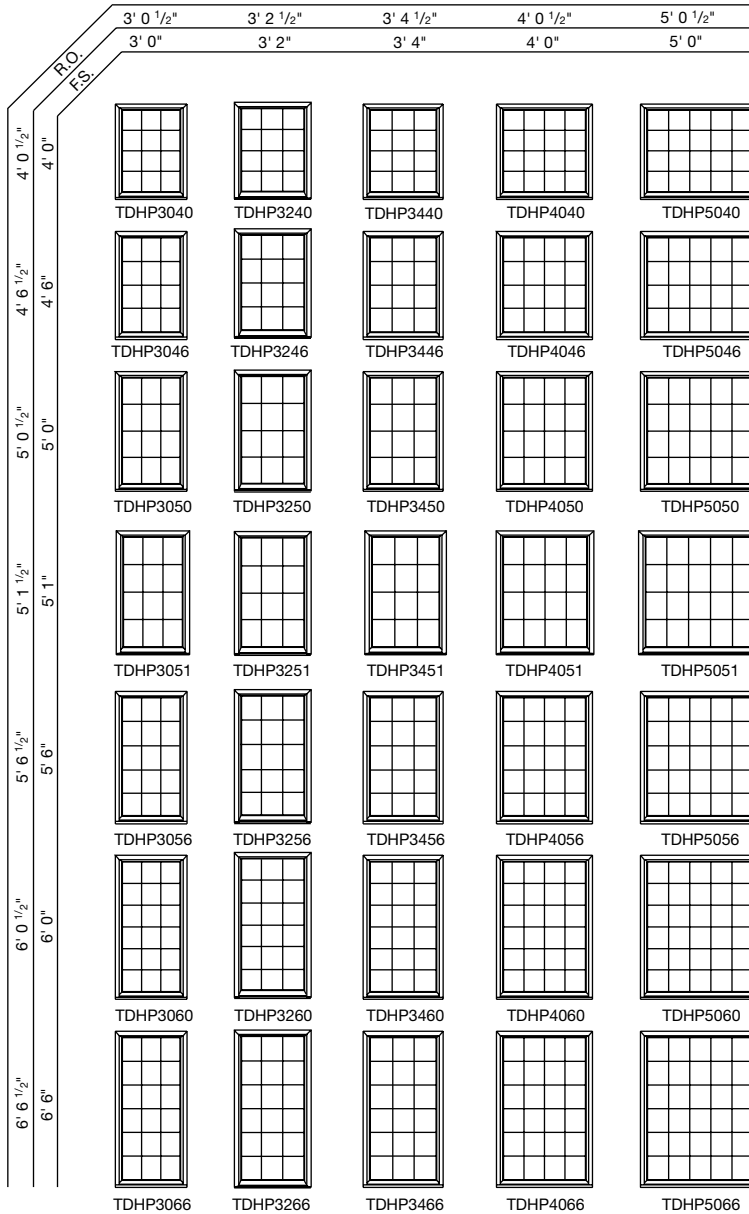

**NOTES**

If glass is positioned within 18" of the finished floor, safety/tempered glass may be required. Local codes may differ. Verify tempered glass requirements with your local building code official.

Use structural joining material when necessary or required by code.

The light patterns illustrated apply to rectangular removable interior wood grilles, Full Divided Light, Simulated Divided Light, Decorelle 100, 150 and 400 and Finelight™ Grilles-Between-the-Glass. All removable interior wood grilles will be installed in the units unless otherwise specified.

For a metric conversion in millimeters, multiply dimensions in inches by 25.4.

**FORMULA FOR COMBINATION WINDOWS**

The overall frame dimension (both width and height) is equal to the sum of the individual unit frame dimensions plus joining material dimension(s).

The overall rough opening (both width and height) is equal to the overall frame dimensions plus 1/4" on all sides.

E-Series Double-Hung Windows



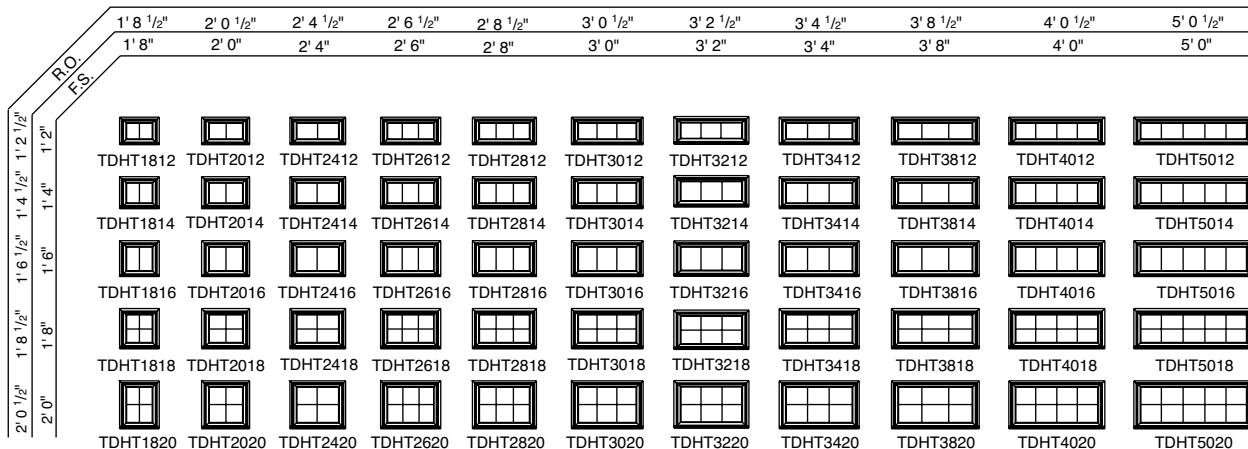













































### Double-Hung Transom Window Sizes



FOR WINDOWS GREATER THAN 30 SQUARE FEET OR RATED HIGHER THAN PG50, ONE OF THESE THREE INSTALLATION METHODS IS REQUIRED:  
A) THROUGH THE JAMB B) ALUMINUM INSTALLATION FLANGE OR C) INSTALLATION CLIPS.  
ADDITIONAL CUSTOM SIZES ARE AVAILABLE. CONTACT YOUR LOCAL SUPPLIER FOR MORE INFORMATION. DRAWINGS ARE NOT TO SCALE.

# DOUBLE-HUNG WINDOWS

## Arch Single-Hung Window Sizes

		2'-0" <sup>1</sup> / <sub>2</sub> "	4'-0" <sup>1</sup> / <sub>2</sub> "	2'-4" <sup>1</sup> / <sub>2</sub> "	4'-8" <sup>1</sup> / <sub>2</sub> "	2'-6" <sup>1</sup> / <sub>2</sub> "	5'-0" <sup>1</sup> / <sub>2</sub> "
		2'-0"	4'-0"	2'-4"	4'-8"	2'-6"	5'-0"
		3'-0" RAD	6'-0" RAD	3'-0" RAD	6'-0" RAD	3'-0" RAD	6'-0" RAD
R.O. F.S.	3'-0" <sup>1</sup> / <sub>2</sub> "						
		TCLR DH2030	TCLR DH2030-2	TCLR DH2430	TCLR DH2430-2	TCLR DH2630	TCLR DH2630-2
	3'-4" <sup>1</sup> / <sub>2</sub> "						
		TCLR DH2034	TCLR DH2034-2	TCLR DH2434	TCLR DH2434-2	TCLR DH2634	TCLR DH2634-2
	4'-0" <sup>1</sup> / <sub>2</sub> "						
		TCLR DH2040	TCLR DH2040-2	TCLR DH2440	TCLR DH2440-2	TCLR DH2640	TCLR DH2640-2
	4'-6" <sup>1</sup> / <sub>2</sub> "						
	TCLR DH2046	TCLR DH2046-2	TCLR DH2446	TCLR DH2446-2	TCLR DH2646	TCLR DH2646-2	
5'-0" <sup>1</sup> / <sub>2</sub> "							
	TCLR DH2050	TCLR DH2050-2	TCLR DH2450	TCLR DH2450-2	TCLR DH2650	TCLR DH2650-2	
5'-1" <sup>1</sup> / <sub>2</sub> "							
	TCLR DH2051	TCLR DH2051-2	TCLR DH2451	TCLR DH2451-2	TCLR DH2651	TCLR DH2651-2	
5'-6" <sup>1</sup> / <sub>2</sub> "							
	TCLR DH2056	TCLR DH2056-2	TCLR DH2456	TCLR DH2456-2	TCLR DH2656	TCLR DH2656-2	
6'-0" <sup>1</sup> / <sub>2</sub> "							
	TCLR DH2060	TCLR DH2060-2	TCLR DH2460	TCLR DH2460-2	TCLR DH2660	TCLR DH2660-2	

### NOTES

Units may be ordered with sash lifts if desired. Units 3' 0" and wider will use two sash lifts.

Bottom sash operates up and down and tilts inward for cleaning. Top sash is fixed.

If glass is positioned within 18" of the finished floor, safety/tempered glass may be required. Local codes may differ. Verify tempered glass requirements with your local building code official.

Use structural joining material when necessary or required by code.

The light patterns illustrated apply to rectangular removable interior wood grilles, Full Divided Light, Simulated Divided Light, Decorelle 100, 150 and 400 and Finelight™ Grilles-Between-the-Glass. All removable interior wood grilles will be installed in the units unless otherwise specified.

For a metric conversion in millimeters, multiply dimensions in inches by 25.4.

### FORMULA FOR COMBINATION WINDOWS

The overall frame dimension (both width and height) is equal to the sum of the individual unit frame dimensions plus joining material dimension(s).

The overall rough opening (both width and height) is equal to the overall frame dimensions plus 1/4" on all sides.

FOR WINDOWS GREATER THAN 30 SQUARE FEET OR RATED HIGHER THAN PG50, ONE OF THESE THREE INSTALLATION METHODS IS REQUIRED:  
 A) THROUGH THE JAMB B) ALUMINUM INSTALLATION FLANGE OR C) INSTALLATION CLIPS.  
 ADDITIONAL CUSTOM SIZES ARE AVAILABLE. CONTACT YOUR LOCAL SUPPLIER FOR MORE INFORMATION. DRAWINGS ARE NOT TO SCALE.

**Arch Single-Hung Window Sizes**

	2'-8 1/2"	5'-4 1/2"	3'-0 1/2"	6'-0 1/2"	3'-2 1/2"	6'-4 1/2"
	2'-8"	5'-4"	3'-0"	6'-0"	3'-2"	6'-4"
	3'-0" RAD	6'-0" RAD	3'-0" RAD	6'-0" RAD	3'-0" RAD	6'-0" RAD
3'-0" 1/2"						
3'-0"	TCLRDH2830	TCLRDH2830-2	TCLRDH3030	TCLRDH3030-2	TCLRDH3230	
3'-4 1/2"						
3'-4"	TCLRDH2834	TCLRDH2834-2	TCLRDH3034	TCLRDH3034-2	TCLRDH3234	
4'-0 1/2"						
4'-0"	TCLRDH2840	TCLRDH2840-2	TCLRDH3040	TCLRDH3040-2	TCLRDH3240	TCLRDH3240-2
4'-6 1/2"						
4'-6"	TCLRDH2846	TCLRDH2846-2	TCLRDH3046	TCLRDH3046-2	TCLRDH3246	TCLRDH3246-2
5'-0 1/2"						
5'-0"	TCLRDH2850	TCLRDH2850-2	TCLRDH3050	TCLRDH3050-2	TCLRDH3250	TCLRDH3250-2
5'-1 1/2"						
5'-1"	TCLRDH2851	TCLRDH2851-2	TCLRDH3051	TCLRDH3051-2	TCLRDH3251	TCLRDH3251-2
5'-6 1/2"						
5'-6"	TCLRDH2856	TCLRDH2856-2	TCLRDH3056	TCLRDH3056-2	TCLRDH3256	TCLRDH3256
6'-0 1/2"						
6'-0"	TCLRDH2860	TCLRDH2860-2	TCLRDH3060	TCLRDH3060-2	TCLRDH3260	TCLRDH3260-2

E-Series Double-Hung Windows

**NOTES**

Units may be ordered with sash lifts if desired. Units 3'0" and wider will use two sash lifts.

Bottom sash operates up and down and tilts inward for cleaning. Top sash is fixed.

If glass is positioned within 18" of the finished floor, safety/tempered glass may be required. Local codes may differ. Verify tempered glass requirements with your local building code official.

Use structural joining material when necessary or required by code.

The light patterns illustrated apply to rectangular removable interior wood grilles, Full Divided Light, Simulated Divided Light, Decorelle 100, 150 and 400 and Finelight™ Grilles-Between-the-Glass. All removable interior wood grilles will be installed in the units unless otherwise specified.

For a metric conversion in millimeters, multiply dimensions in inches by 25.4.

**FORMULA FOR COMBINATION WINDOWS**











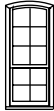
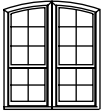
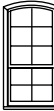

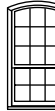
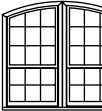
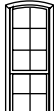
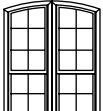

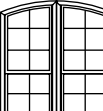

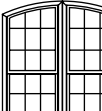

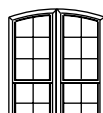
The overall frame dimension (both width and height) is equal to the sum of the individual unit frame dimensions plus joining material dimension(s).

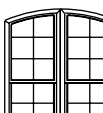
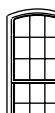
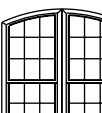
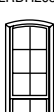
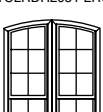
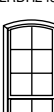
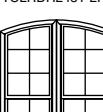
The overall rough opening (both width and height) is equal to the overall frame dimensions plus 1/4" on all sides.

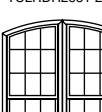
**FOR WINDOWS GREATER THAN 30 SQUARE FEET OR RATED HIGHER THAN PG50, ONE OF THESE THREE INSTALLATION METHODS IS REQUIRED: A) THROUGH THE JAMB B) ALUMINUM INSTALLATION FLANGE OR C) INSTALLATION CLIPS. ADDITIONAL CUSTOM SIZES ARE AVAILABLE. CONTACT YOUR LOCAL SUPPLIER FOR MORE INFORMATION. DRAWINGS ARE NOT TO SCALE.**

# DOUBLE-HUNG WINDOWS

## Arch Reverse Cottage Single-Hung Window Sizes

		2'-0 1/2"	4'-0 1/2"	2'-4 1/2"	4'-8 1/2"	2'-6 1/2"	5'-0 1/2"
		2'-0"	4'-0"	2'-4"	4'-8"	2'-6"	5'-0"
		3'-0" RAD	6'-0" RAD	3'-0" RAD	6'-0" RAD	3'-0" RAD	6'-0" RAD
R.O. F.S.	4'-6 1/2" 4'-6"						
		TCLRDH2046RC	TCLRDH2046-2RC	TCLRDH2446RC	TCLRDH2446-2RC	TCLRDH2646RC	TCLRDH2646-2RC
	5'-0 1/2" 5'-0"						
		TCLRDH2050RC	TCLRDH2050-2RC	TCLRDH2450RC	TCLRDH2450-2RC	TCLRDH2650RC	TCLRDH2650-2RC
	5'-1 1/2" 5'-1"						
	TCLRDH2051RC	TCLRDH2051-2RC	TCLRDH2451RC	TCLRDH2451-2RC	TCLRDH2651RC	TCLRDH2651-2RC	
5'-6 1/2" 5'-6"							
	TCLRDH2056RC	TCLRDH2056-2RC	TCLRDH2456RC	TCLRDH2456-2RC	TCLRDH2656RC	TCLRDH2656-2RC	
6'-0 1/2" 6'-0"							
	TCLRDH2060RC	TCLRDH2060-2RC	TCLRDH2460RC	TCLRDH2460-2RC	TCLRDH2660RC	TCLRDH2660-2RC	

### NOTES

Units may be ordered with sash lifts if desired. Units 3'0" and wider will use two sash lifts.

Bottom sash operates up and down and tilts inward for cleaning. Top sash is fixed.

If glass is positioned within 18" of the finished floor, safety/tempered glass may be required. Local codes may differ. Verify tempered glass requirements with your local building code official.

Use structural joining material when necessary or required by code.

The light patterns illustrated apply to rectangular removable interior wood grilles, Full Divided Light, Simulated Divided Light, Decorelle 100, 150 and 400 and Finelight™ Grilles-Between-the-Glass. All removable interior wood grilles will be installed in the units unless otherwise specified.

For a metric conversion in millimeters, multiply dimensions in inches by 25.4.

### FORMULA FOR COMBINATION WINDOWS

The overall frame dimension (both width and height) is equal to the sum of the individual unit frame dimensions plus joining material dimension(s).

The overall rough opening (both width and height) is equal to the overall frame dimensions plus 1/4" on all sides.

FOR WINDOWS GREATER THAN 30 SQUARE FEET OR RATED HIGHER THAN PG50, ONE OF THESE THREE INSTALLATION METHODS IS REQUIRED:  
 A) THROUGH THE JAMB B) ALUMINUM INSTALLATION FLANGE OR C) INSTALLATION CLIPS.  
 ADDITIONAL CUSTOM SIZES ARE AVAILABLE. CONTACT YOUR LOCAL SUPPLIER FOR MORE INFORMATION. DRAWINGS ARE NOT TO SCALE.



### Arch Reverse Cottage Single-Hung Window Sizes

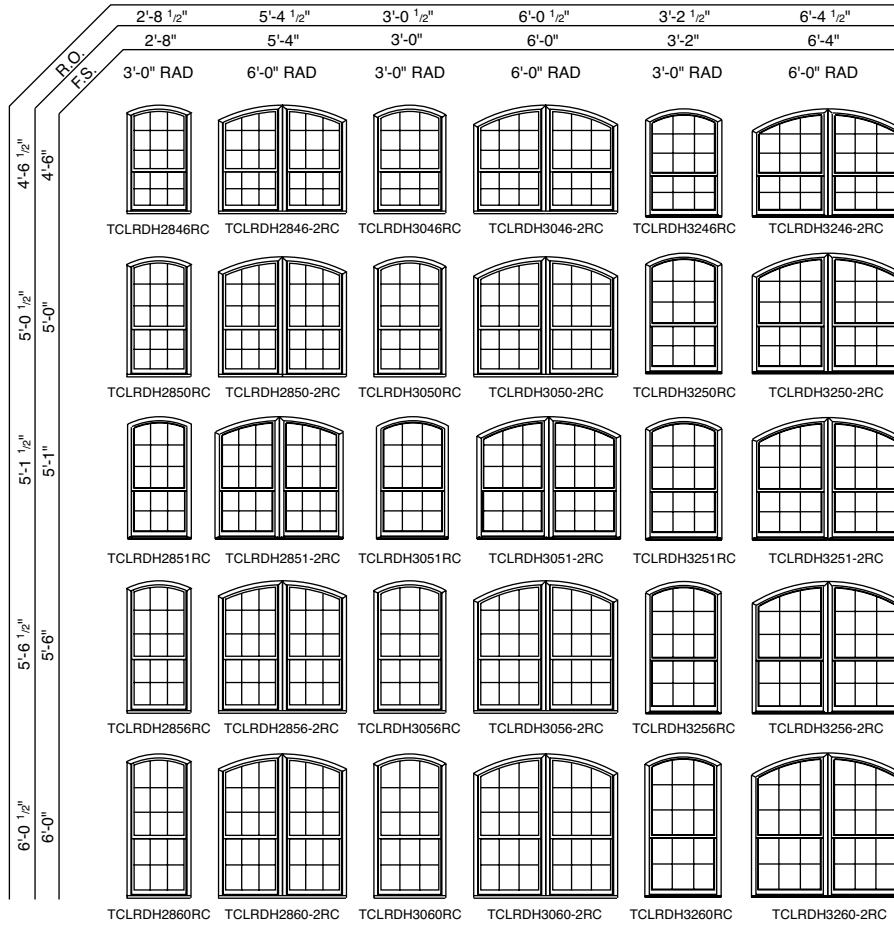

**NOTES**

Units may be ordered with sash lifts if desired. Units 3' 0" and wider will use two sash lifts.

Bottom sash operates up and down and tilts inward for cleaning. Top sash is fixed.

If glass is positioned within 18" of the finished floor, safety/tempered glass may be required. Local codes may differ. Verify tempered glass requirements with your local building code official.

Use structural joining material when necessary or required by code.

The light patterns illustrated apply to rectangular removable interior wood grilles, Full Divided Light, Simulated Divided Light, Decorelle 100, 150 and 400 and Finelight™ Grilles-Between-the-Glass. All removable interior wood grilles will be installed in the units unless otherwise specified.

For a metric conversion in millimeters, multiply dimensions in inches by 25.4.

**FORMULA FOR COMBINATION WINDOWS**

The overall frame dimension (both width and height) is equal to the sum of the individual unit frame dimensions plus joining material dimension(s).

The overall rough opening (both width and height) is equal to the overall frame dimensions plus 1/4" on all sides.

E-Series Double-Hung Windows

### Double-Hung Direct-Set Transom Window Sizes

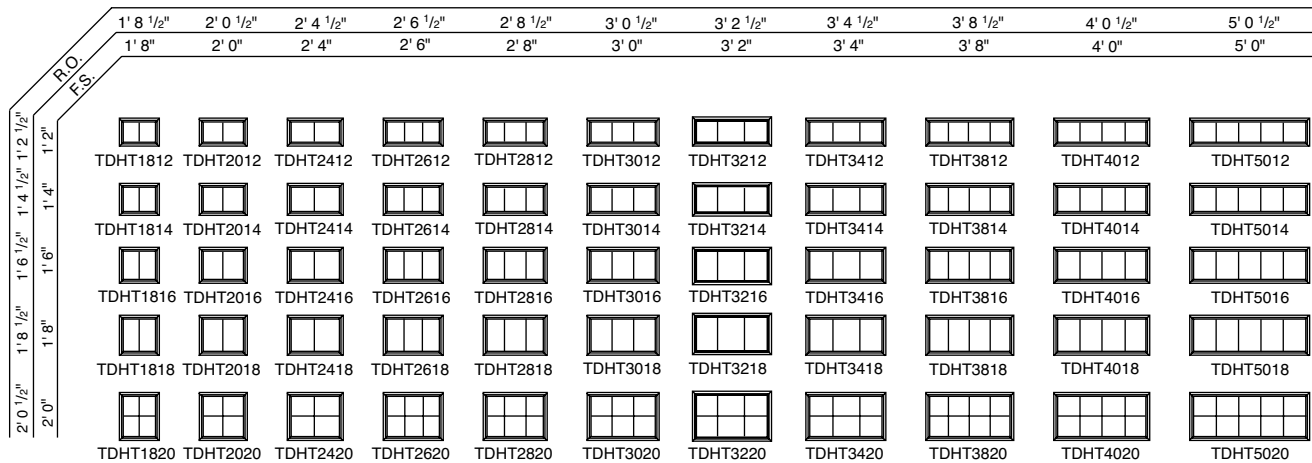

FOR WINDOWS GREATER THAN 30 SQUARE FEET OR RATED HIGHER THAN PG50, ONE OF THESE THREE INSTALLATION METHODS IS REQUIRED:  
A) THROUGH THE JAMB B) ALUMINUM INSTALLATION FLANGE OR C) INSTALLATION CLIPS.  
ADDITIONAL CUSTOM SIZES ARE AVAILABLE. CONTACT YOUR LOCAL SUPPLIER FOR MORE INFORMATION. DRAWINGS ARE NOT TO SCALE.

# DOUBLE-HUNG WINDOWS

## Monumental Single-Hung Window Sizes

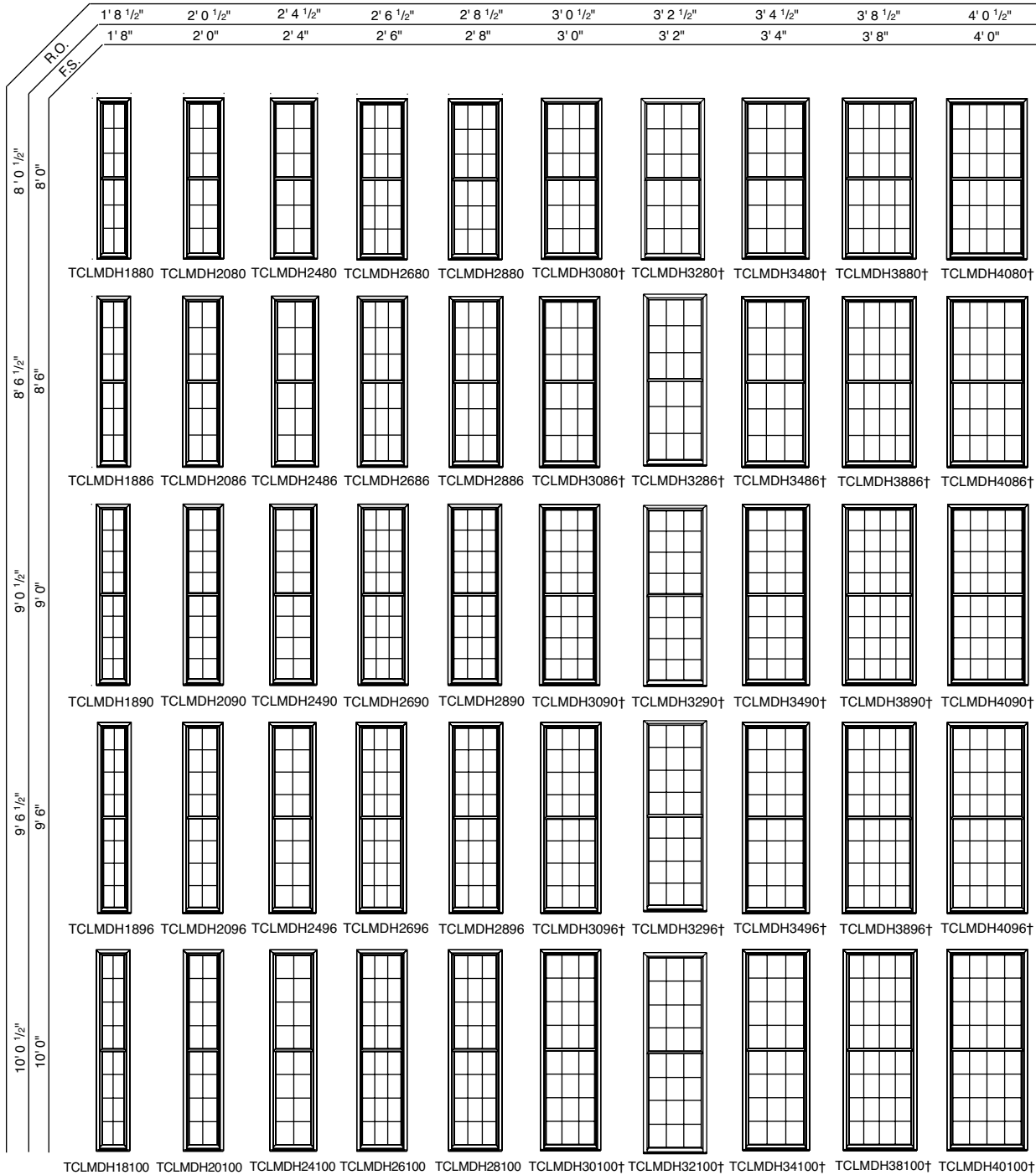

### NOTES

† These units meet or exceed the following dimensions: Clear Opening Area 5.7 sq. ft., Clear Opening Width 20", Clear Opening Height 24" and 44" maximum floor to sill height (with standard 6' 10-1/2" structural header height). See your local code official for requirements in your area.

Units may be ordered with sash lifts if desired. Units 3' 0" and wider will use two sash lifts.

Bottom sash operates up and down but does not tilt. Top sash is fixed.

Units equal to or greater than 8' 0" tall are limited to 24" of clear opening height.

Sash Ratio: Standard units are equal sash. However, Cottage and Reverse Cottage are available as an option with some limitations. Contact your local supplier for more information.

See notes on page 73 for more information.

**FOR WINDOWS GREATER THAN 30 SQUARE FEET OR RATED HIGHER THAN PG50, ONE OF THESE THREE INSTALLATION METHODS IS REQUIRED:  
A) THROUGH THE JAMB B) ALUMINUM INSTALLATION FLANGE OR C) INSTALLATION CLIPS.  
ADDITIONAL CUSTOM SIZES ARE AVAILABLE. CONTACT YOUR LOCAL SUPPLIER FOR MORE INFORMATION. DRAWINGS ARE NOT TO SCALE.**

**Monumental Single-Hung Window Sizes**

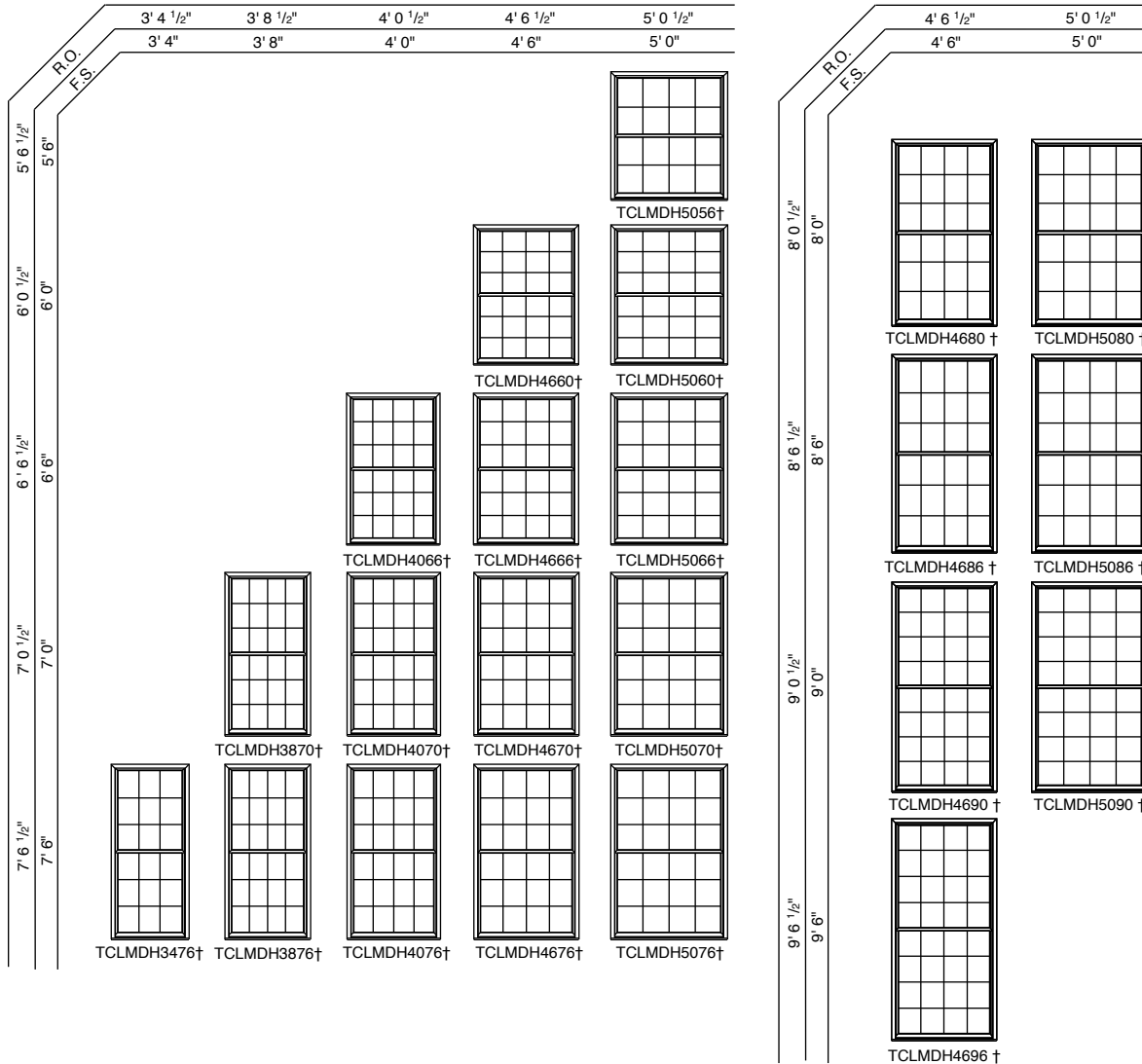

**NOTES**

† These units meet or exceed the following dimensions: Clear Opening Area 5.7 sq. ft., Clear Opening Width 20", Clear Opening Height 24" and 44" maximum floor to sill height (with standard 6' 10-1/2" structural header height). See your local code official for requirements in your area.

Units may be ordered with sash lifts if desired. Units 3' 0" and wider will use two sash lifts.

Bottom sash operates up and down but does not tilt. Top sash is fixed.

Units equal to or greater than 8' 0" tall are limited to 24" of clear opening height.

Sash Ratio: Standard units are equal sash. However, Cottage and Reverse Cottage are available as an option with some limitations. Contact your local supplier for more information.

If glass is positioned within 18" of the finished floor, safety/tempered glass may be required. Local codes may differ. Verify tempered glass requirements with your local building code official.

Use structural joining material when necessary or required by code.

The light patterns illustrated apply to rectangular removable interior wood grilles, Full Divided Light, Simulated Divided Light, Decorelle 100, 150 and 400 and Finelight™ Grilles-Between-the-Glass. All removable interior wood grilles will be installed in the units unless otherwise specified.

For a metric conversion in millimeters, multiply dimensions in inches by 25.4.

**FORMULA FOR COMBINATION WINDOWS**

The overall frame dimension (both width and height) is equal to the sum of the individual unit frame dimensions plus joining material dimension(s).

The overall rough opening (both width and height) is equal to the overall frame dimensions plus 1/4" on all sides.

**FOR WINDOWS GREATER THAN 30 SQUARE FEET OR RATED HIGHER THAN PG50, ONE OF THESE THREE INSTALLATION METHODS IS REQUIRED:  
A) THROUGH THE JAMB B) ALUMINUM INSTALLATION FLANGE OR C) INSTALLATION CLIPS.  
ADDITIONAL CUSTOM SIZES ARE AVAILABLE. CONTACT YOUR LOCAL SUPPLIER FOR MORE INFORMATION. DRAWINGS ARE NOT TO SCALE.**

## Double-Hung Windows

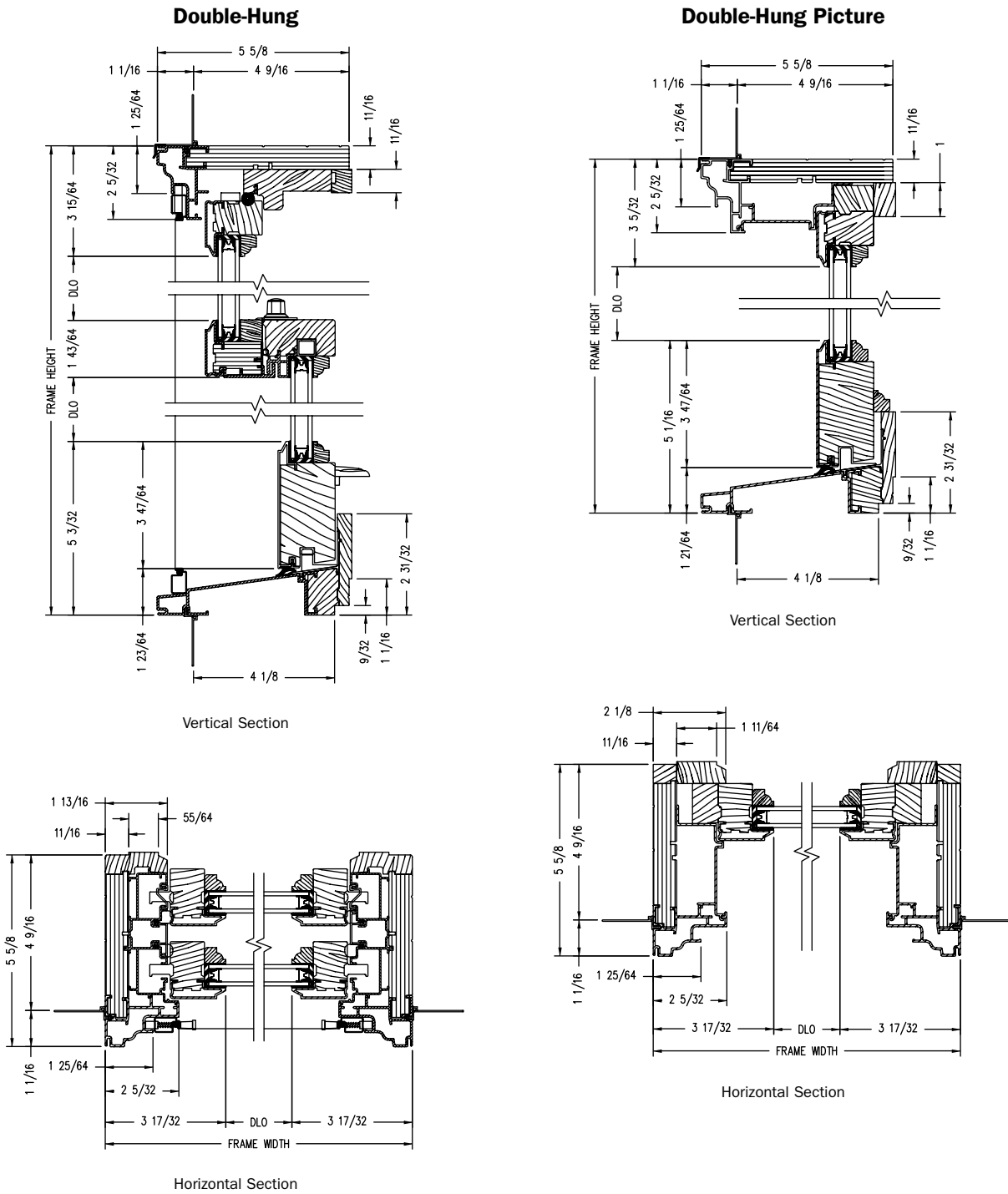

Shown with ovolo (colonial) glass stops.

PROPER INSTALLATION AND MAINTENANCE OF E-SERIES PRODUCTS IS ESSENTIAL TO ATTAIN OPTIMUM PERFORMANCE AND OPERATION. WRITTEN INSTALLATION INSTRUCTIONS THAT PROVIDE GUIDELINES FOR PROPER INSTALLATION ARE AVAILABLE BY VISITING [ANDERSENWINDOWS.COM](http://ANDERSENWINDOWS.COM). CUSTOM SIZES ARE AVAILABLE. CONTACT YOUR LOCAL SUPPLIER FOR MORE INFORMATION. DRAWINGS ARE NOT TO SCALE.

**Double-Hung Windows**

**Double-Hung Transom**

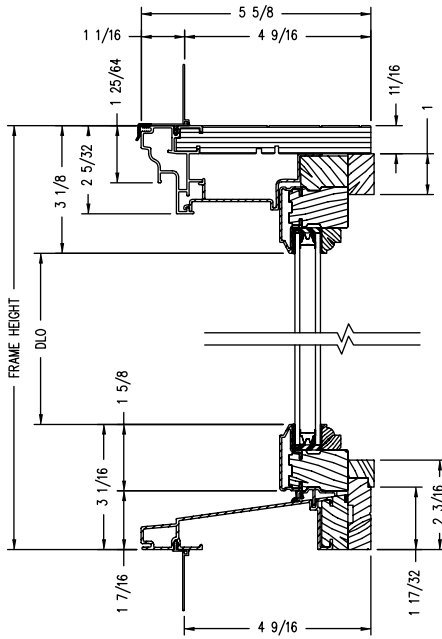

Vertical Section

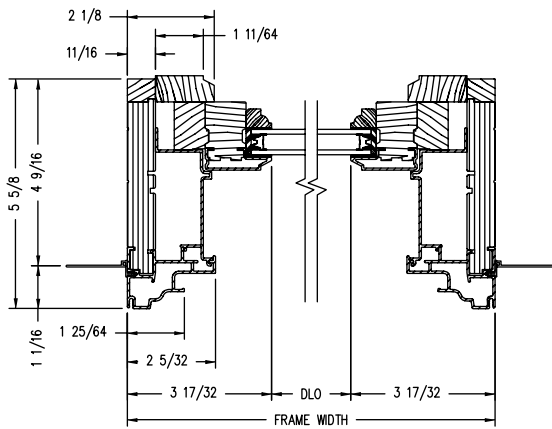

Horizontal Section

**Monumental Single-Hung**

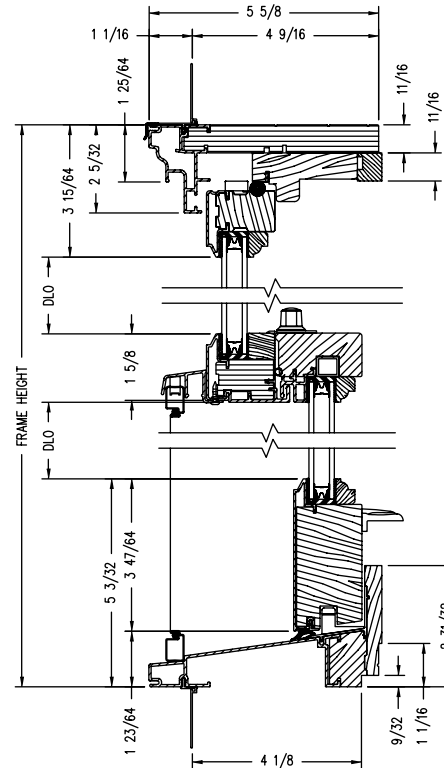

Vertical Section

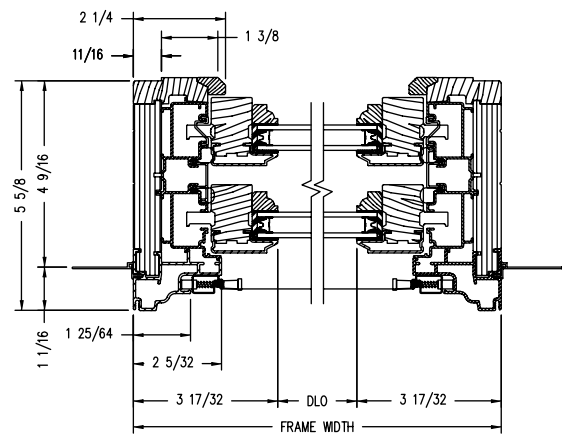

Horizontal Section

Shown with ovolo (colonial) glass stops.

PROPER INSTALLATION AND MAINTENANCE OF E-SERIES PRODUCTS IS ESSENTIAL TO ATTAIN OPTIMUM PERFORMANCE AND OPERATION. WRITTEN INSTALLATION INSTRUCTIONS THAT PROVIDE GUIDELINES FOR PROPER INSTALLATION ARE AVAILABLE BY VISITING [ANDERSENWINDOWS.COM](http://ANDERSENWINDOWS.COM). CUSTOM SIZES ARE AVAILABLE. CONTACT YOUR LOCAL SUPPLIER FOR MORE INFORMATION. DRAWINGS ARE NOT TO SCALE.

E-Series Double-Hung Windows

## Double-Hung Insert Windows

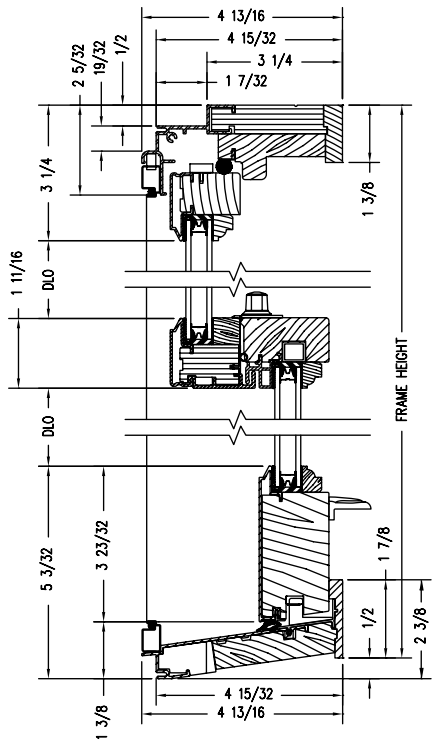

Vertical Section  
(For sill angles 8° and greater)

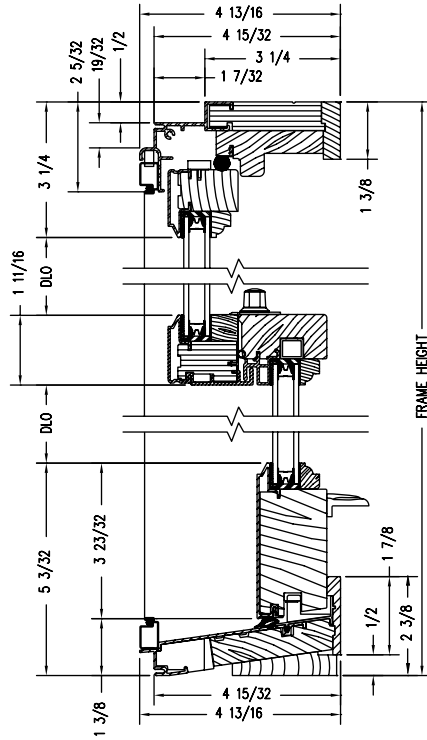

Vertical Section  
(For sill angles less than 8°)

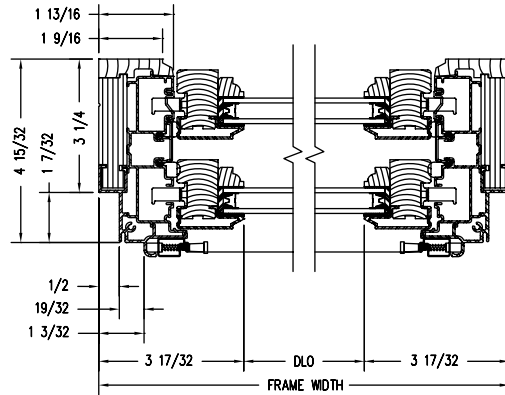

Horizontal Section

Shown with ovolo (colonial) glass stops.

PROPER INSTALLATION AND MAINTENANCE OF E-SERIES PRODUCTS IS ESSENTIAL TO ATTAIN OPTIMUM PERFORMANCE AND OPERATION. WRITTEN INSTALLATION INSTRUCTIONS THAT PROVIDE GUIDELINES FOR PROPER INSTALLATION ARE AVAILABLE BY VISITING [ANDERSENWINDOWS.COM](http://ANDERSENWINDOWS.COM). CUSTOM SIZES ARE AVAILABLE. CONTACT YOUR LOCAL SUPPLIER FOR MORE INFORMATION. DRAWINGS ARE NOT TO SCALE.

**Double-Hung Picture Insert Windows**

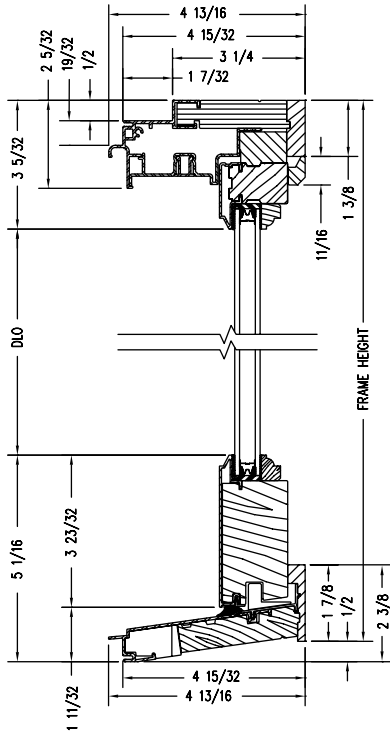

Vertical Section  
(For sill angles 8° and greater)

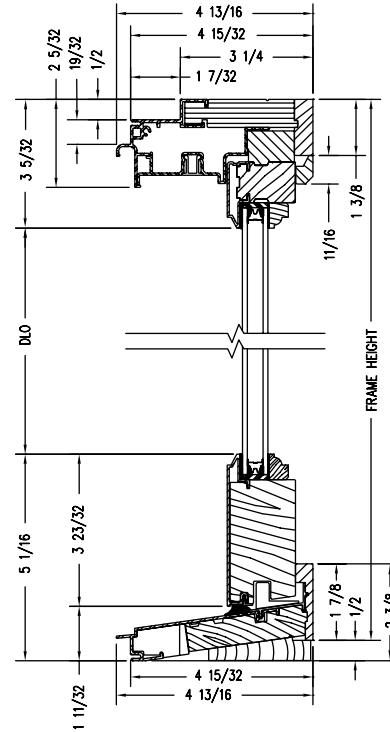

Vertical Section  
(For sill angles less than 8°)

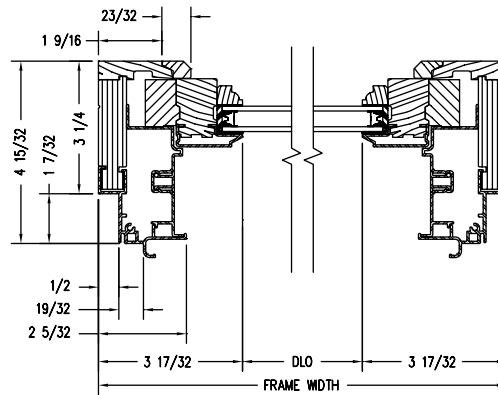

Horizontal Section

Shown with ovolo (colonial) glass stops.

E-Series Double-Hung  
Windows

PROPER INSTALLATION AND MAINTENANCE OF E-SERIES PRODUCTS IS ESSENTIAL TO ATTAIN OPTIMUM PERFORMANCE AND OPERATION. WRITTEN INSTALLATION INSTRUCTIONS THAT PROVIDE GUIDELINES FOR PROPER INSTALLATION ARE AVAILABLE BY VISITING [ANDERSENWINDOWS.COM](http://ANDERSENWINDOWS.COM). CUSTOM SIZES ARE AVAILABLE. CONTACT YOUR LOCAL SUPPLIER FOR MORE INFORMATION. DRAWINGS ARE NOT TO SCALE.

## Double-Hung Sash Replacement Kits

### Double-Hung Sash Replacement

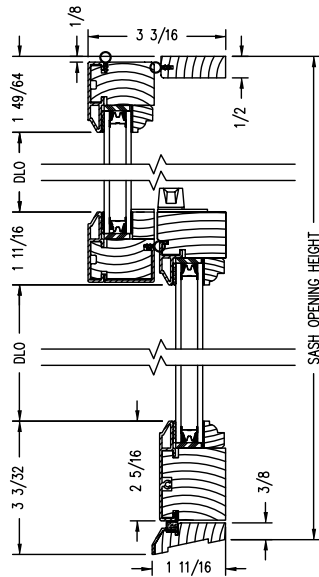

Vertical Section

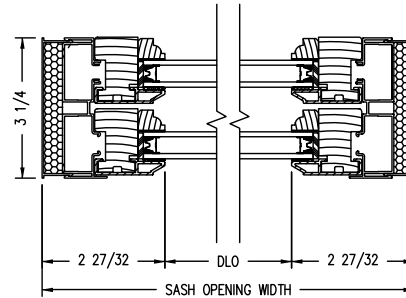

Horizontal Section

### Double-Hung Picture Sash Replacement

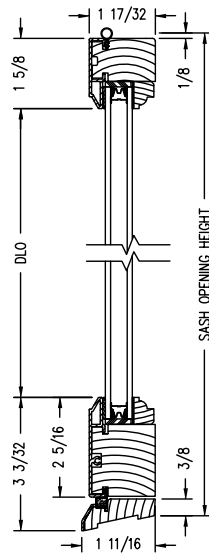

Vertical Section

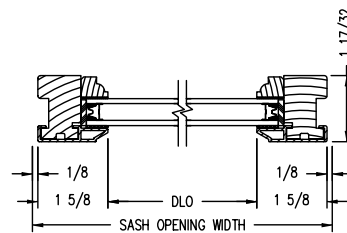

Horizontal Section

Shown with ovolo (colonial) glass stops.

PROPER INSTALLATION AND MAINTENANCE OF E-SERIES PRODUCTS IS ESSENTIAL TO ATTAIN OPTIMUM PERFORMANCE AND OPERATION. WRITTEN INSTALLATION INSTRUCTIONS THAT PROVIDE GUIDELINES FOR PROPER INSTALLATION ARE AVAILABLE BY VISITING [ANDERSENWINDOWS.COM](http://ANDERSENWINDOWS.COM). CUSTOM SIZES ARE AVAILABLE. CONTACT YOUR LOCAL SUPPLIER FOR MORE INFORMATION. DRAWINGS ARE NOT TO SCALE.



## Notes

A large grid area for taking notes, consisting of a 30x40 grid of small squares.

# BAY & BOW WINDOWS

E-Series bay and bow windows provide a focal point that is architecturally consistent inside and out, making any room feel spacious. They feature consistent sight lines when integrated with double-hung or casement windows, head and seat boards in birch or oak and an all-inclusive accessory package when ordered as a kit.

---

<b>Bay &amp; Bow Overview</b> .....	<b>82</b>
Sizing	
10° Casement Bow .....	84
30° & 45° Casement Bay .....	85
90° Casement Box Bay .....	86
30° Double-Hung Bay .....	89
45° Double-Hung Bay .....	90
Details	
Casement .....	87
Double-Hung .....	91
Installation Materials .....	154
Product Performance .....	158





# BAY & BOW WINDOWS

## FEATURES

### BAY & BOW WINDOWS

**A** Select wood components are kiln dried and treated with water/insect repellent and preservative. Interior wood surfaces are available in pine, mixed grain Douglas fir, cherry, hickory, mahogany\*, maple, oak, walnut, alder or vertical grain Douglas fir. Interior surfaces are available unfinished or factory primed. Factory-applied finishes are available in a variety of stain and paint options.

Wood components are fitted with aluminum extrusions on the exterior. 50 exterior colors that meet AAMA 2604 and 2605 specifications are available, as well as custom colors. Also available is a selection of seven exterior anodized options.

Compression bulb weatherstrip is applied for a maximum weather seal.

### GLASS

**B** High-Performance Low-E4® glass with a low-conductivity spacer. Triple-pane glass, tinted, clear dual-pane, high-altitude glass and other special glazing options are available.

Glass is fixed in place from the interior with wood stops that can be removed for easy reglazing if necessary. Glass stops available in ovolo (colonial) and contemporary profiles.



Double-Hung Bay Window

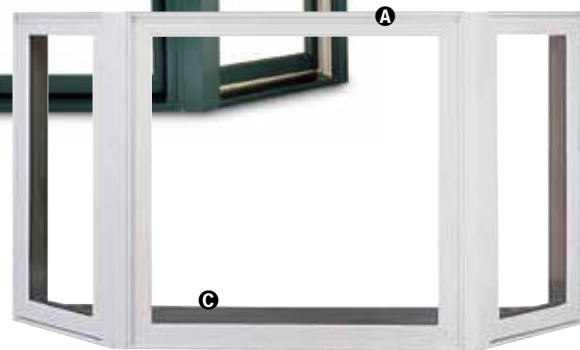

Casement Bay Window

### CABLE SUPPORT SYSTEM

Support is required underneath all bay and bow units. We offer a cable support system for your use. Insulated platforms and brackets are not included.



### HEAD & SEAT BOARDS

**C** Wood head and seat boards are available in birch or oak.

## EXTERIOR & INTERIOR OPTIONS

**EXTERIOR COLORS** 50 exterior colors, 7 anodized finishes and custom colors. See exterior colors on page 11.

### INTERIOR WOOD SPECIES

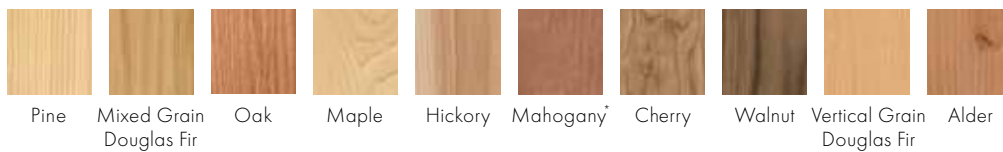

Naturally occurring variations in grain, color and texture of wood make each window one of a kind.

All factory-finished options are shown on pine.

Painted options available on pine. Dark bronze and black painted options available on pine or maple. Anodized silver painted option available on maple only.

Interior custom stains, paints and color matching available.

### FACTORY-FINISHED INTERIORS

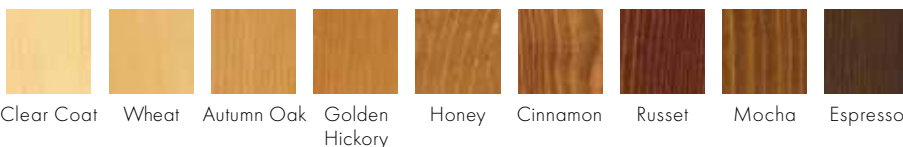

### INTERIOR PAINTED OPTIONS

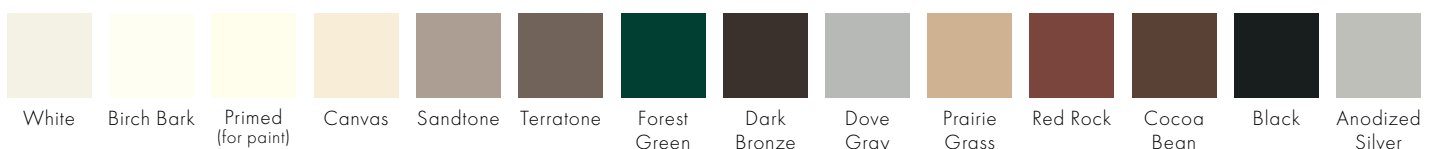

\*Actual wood species is either Sapele or Sipo, both non-endangered species grown in Africa, with color and characteristics similar to Central American mahoganies. Printing limitations prevent exact replication of colors and finishes. Please see your Andersen supplier for actual color and finish samples.

**ACCESSORIES** Sold Separately

**BAY & BOW WINDOWS**

**SENSORS**

**VeriLock® Security Sensors**



VeriLock sensors are unique as they detect whether the windows are locked or unlocked\* — a feature no other sensors can provide. Available in all hardware finishes. VeriLock sensors for double-hung sash lock shown above. Also available for casement windows. See page 27 for Smart Home options.

**INSECT SCREENS**

Charcoal fiberglass screen mesh fits into an aluminum frame. Aluminum screen mesh is available as an option.

See casement or double-hung sections for additional insect screen options.

**PRIVACY OPTIONS**

**System 3 Blinds for Casement Windows**



A 5/8" aluminum slat blind is mounted to an extruded aluminum blind panel and applied to the window, creating a triple-glazed window boasting privacy and energy efficiency. Available in three colors. Blind panels are offered in white, tan, gold or an optional wood veneer to match your interior.

**System 3 Shades for Casement Windows**

Pleated fabric shades are available in four colors to effortlessly and beautifully filter the light. See page 25 for more details.

**GRILLES**

**Full Divided Light**

Permanent interior and exterior grilles with grille spacer bars between two panes of glass. Available in 5/8", 7/8", 1 1/8", 1 1/2", or 2 1/4" widths. Interior grilles are available with ovolo or contemporary profile (ovolo profile shown below). Not all widths are shown.



**Simulated Divided Light**

Permanent exterior and interior grilles without grille spacer bars. Available in 5/8", 7/8", 1 1/8", 1 1/2", or 2 1/4" widths. Interior grilles are available with ovolo or contemporary profile (ovolo profile shown below). Not all widths are shown.



**Finelight™ Grilles-Between-the-Glass**

Available in 5/8" flat or 1" contoured aluminum profiles. Two-tone colors of pebble tan/colony white, sierra bronze/colony white or forest green/colony white are available on the 1" profile.



5/8" Flat | 1" Contoured

**Removable Interior Wood Grilles**

Removable interior wood grilles are available in a 7/8" width and ovolo or contemporary profiles. Optional surround for removable grille and permanent exterior grilles also available.



7/8"

See page 22 for more information on grilles.

E-Series Bay & Bow Windows

**HARDWARE OPTIONS**

**Double-Hung**



Lock



Sash Lift

Antique Brass | Black | **Bright Chrome** | Bronze | Gold  
Oil Rubbed Bronze | Pewter | Polished Brass | Satin Chrome | White

Windows with VeriLock sensors use a different sash lock. See above for details.

**Casement**



Folding Handle

Antique Brass | **Black** | Bright Chrome | Bronze | Gold  
Oil Rubbed Bronze | Pewter | Polished Brass | Satin Chrome | White

Bold name denotes finish shown.

**HARDWARE FINISHES**



Antique Brass | Black | Bright Chrome | Bronze | Gold | Oil Rubbed Bronze | Pewter | Polished Brass | Satin Chrome | White

Oil rubbed bronze is a "living" finish that will change with time and use.

\*When properly configured and maintained with a professionally installed security system and/or self monitoring system compatible with Honeywell® 5800 controls. See your Andersen supplier for more information.

# BAY & BOW WINDOWS

## 10° Casement Bow Window Sizes

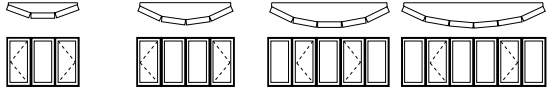

		WIDTH			
Rough Opg.	3-WIDE 4'-6 3/16"	4-WIDE 5'-11 5/8"	5-WIDE 7'-4 9/16"	6-WIDE 8'-8 3/4"	
3'-0 1/2"	15 3/4 30-3	15 3/4 30-4	15 3/4 30-5	15 3/4 30-6	
3'-4 1/2"	15 3/4 34-3	15 3/4 34-4	15 3/4 34-5	15 3/4 34-6	
4'-0 1/2"	15 3/4 40-3	15 3/4 40-4	15 3/4 40-5	15 3/4 40-6	
4'-6 1/2"	15 3/4 46-3	15 3/4 46-4	15 3/4 46-5	15 3/4 46-6	
5'-0 1/2"	15 3/4 50-3	15 3/4 50-4	15 3/4 50-5	15 3/4 50-6	
5'-6 1/2"	15 3/4 56-3	15 3/4 56-4	15 3/4 56-5	15 3/4 56-6	
6'-0 1/2"	15 3/4 60-3	15 3/4 60-4	15 3/4 60-5	15 3/4 60-6	
Projection	0'-3 5/32"	0'-6 1/4"	0'-9 11/32"	1'-1 15/16"	
Rough Opg.	5'-0 7/8"	6'-8 1/2"	8'-3 7/16"	9'-9 11/16"	
3'-0 1/2"	1830-3	1830-4	1830-5	1830-6	
3'-4 1/2"	1834-3	1834-4	1834-5	1834-6	
4'-0 1/2"	1840-3	1840-4	1840-5	1840-6	
4'-6 1/2"	1846-3	1846-4	1846-5	1846-6	
5'-0 1/2"	1850-3	1850-4	1850-5	1850-6	
5'-6 1/2"	1856-3	1856-4	1856-5	1856-6	
6'-0 1/2"	1860-3	1860-4	1860-5	1860-6	
Projection	0'-3 9/16"	0'-7 1/32"	0'-10 1/2"	1'-3 21/32"	
Rough Opg.	6'-0 3/4"	8'-0 3/16"	9'-10 7/8"	11'-8 5/8"	
3'-0 1/2"	2030-3	2030-4	2030-5	2030-6	
3'-4 1/2"	2034-3	2034-4	2034-5	2034-6	
4'-0 1/2"	2040-3	2040-4	2040-5	2040-6	
4'-6 1/2"	2046-3	2046-4	2046-5	2046-6	
5'-0 1/2"	2050-3	2050-4	2050-5	2050-6	
5'-6 1/2"	2056-3	2056-4	2056-5	2056-6	
6'-0 1/2"	2060-3	2060-4	2060-5	2060-6	
Projection	0'-4 1/4"	0'-8 13/32"	1'-0 9/16"	1'-6 3/4"	
Rough Opg.	7'-0 5/8"	9'-3 7/8"	11'-6 1/4"		
3'-0 1/2"	2430-3	2430-4	2430-5	-----	
3'-4 1/2"	2434-3	2434-4	2434-5	-----	
4'-0 1/2"	2440-3	2440-4	2440-5	-----	
4'-6 1/2"	2446-3	2446-4	2446-5	-----	
5'-0 1/2"	2450-3	2450-4	2450-5	-----	
5'-6 1/2"	2456-3	2456-4	2456-5	-----	
6'-0 1/2"	2460-3	2460-4	2460-5	-----	
Projection	0'-4 15/16"	0'-9 13/16"	1'-2 5/8"	-----	
Rough Opg.	7'-6 9/16"	9'-11 11/16"	12'-3 15/16"		
3'-0 1/2"	2630-3	2630-4	2630-5	-----	
3'-4 1/2"	2634-3	2634-4	2634-5	-----	
4'-0 1/2"	2640-3	2640-4	2640-5	-----	
4'-6 1/2"	2646-3	2646-4	2646-5	-----	
5'-0 1/2"	2650-3	2650-4	2650-5	-----	
5'-6 1/2"	2656-3	2656-4	2656-5	-----	
6'-0 1/2"	2660-3	2660-4	2660-5	-----	
Projection	0'-5 5/16"	0'-10 1/2"	1'-3 21/32"	-----	

### NOTES

Projection is measured from the outside of the exterior sheathing to the exterior sheathing line of the outermost unit.

Support is required underneath all bay and bow units. For additional support, we offer a cable support system.

Insulated platforms and brackets are not included.

HEIGHT

FOR WINDOWS GREATER THAN 30 SQUARE FEET OR RATED HIGHER THAN PG50, ONE OF THESE THREE INSTALLATION METHODS IS REQUIRED:  
 A) THROUGH THE JAMB B) ALUMINUM INSTALLATION FLANGE OR C) INSTALLATION CLIPS.  
 ADDITIONAL CUSTOM SIZES ARE AVAILABLE. CONTACT YOUR LOCAL SUPPLIER FOR MORE INFORMATION. DRAWINGS ARE NOT TO SCALE.

### 30° Casement Angle Bay Window Sizes

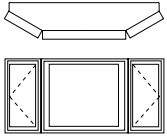

**NOTES**

Projection is measured from the outside of the exterior sheathing to the exterior sheathing line of the outermost unit.

Support is required underneath all bay and bow units. For additional support, we offer a cable support system.

Insulated platforms and brackets are not included.

		WIDTH					
		30 Degree Casement Angle Bay Units					
HEIGHT	Rough Opg.	6'-5 11/16"	7'-1 11/16"	8'-1 11/16"	7'-0 5/8"	7'-8 5/8"	8'-8 5/8"
		1'-8" Wide Flanker Units			2'-0" Wide Flanker Units		
		3'-4" Center	4'-0" Center	5'-0" Center	3'-4" Center	4'-0" Center	5'-0" Center
	4'-0 1/2"	1840-3440-1840	1840-4040-1840	1840-5040-1840	2040-3440-2040	2040-4040-2040	2040-5040-2040
	4'-6 1/2"	1846-3446-1846	1846-4046-1846	1846-5046-1846	2046-3446-2046	2046-4046-2046	2046-5046-2046
	5'-0 1/2"	1850-3450-1850	1850-4050-1850	1850-5050-1850	2050-3450-2050	2050-4050-2050	2050-5050-2050
	5'-6 1/2"	1856-3456-1856	1856-4056-1856	1856-5056-1856	2056-3456-2056	2056-4056-2056	2056-5056-2056
	6'-0 1/2"	1860-3460-1860	1860-4060-1860	1860-5060-1860	2060-3460-2060	2060-4060-2060	2060-5060-2060
	Projection	0'-10 17/32"	0'-10 17/32"	0'-10 17/32"	1'-0 17/32"	1'-0 17/32"	1'-0 17/32"
		7'-7 9/16"					
HEIGHT	Rough Opg.	7'-7 9/16"	8'-3 9/16"	9'-3 9/16"	7'-11"	8'-7"	9'-7"
		2'-4" Wide Flanker Units			2'-6" Wide Flanker Units		
		3'-4" Center	4'-0" Center	5'-0" Center	3'-4" Center	4'-0" Center	5'-0" Center
	4'-0 1/2"	2440-3440-2440	2440-4040-2440	2440-5040-2440	2640-3440-2640	2640-4040-2640	2640-5040-2640
	4'-6 1/2"	2446-3446-2446	2446-4046-2446	2446-5046-2446	2646-3446-2646	2646-4046-2646	2646-5046-2646
	5'-0 1/2"	2450-3450-2450	2450-4050-2450	2450-5050-2450	2650-3450-2650	2650-4050-2650	2650-5050-2650
	5'-6 1/2"	2456-3456-2456	2456-4056-2456	2456-5056-2456	2656-3456-2656	2656-4056-2656	2656-5056-2656
	6'-0 1/2"	2460-3460-2460	2460-4060-2460	2460-5060-2460	2660-3460-2660	2660-4060-2660	2660-5060-2660
	Projection	1'-2 17/32"	1'-2 17/32"	1'-2 17/32"	1'-3 17/32"	1'-3 17/32"	1'-3 17/32"

### 45° Casement Angle Bay Window Sizes

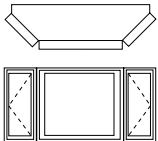

		WIDTH					
		45 Degree Casement Angle Bay Units					
HEIGHT	Rough Opg.	6'-0 3/4"	6'-8 3/4"	7'-8 3/4"	6'-6 3/8"	7'-2 3/8"	8'-2 3/8"
		1'-8" Wide Flanker Units			2'-0" Wide Flanker Units		
		3'-4" Center	4'-0" Center	5'-0" Center	3'-4" Center	4'-0" Center	5'-0" Center
	4'-0 1/2"	1840-3440-1840	1840-4040-1840	1840-5040-1840	2040-3440-2040	2040-4040-2040	2040-5040-2040
	4'-6 1/2"	1846-3446-1846	1846-4046-1846	1846-5046-1846	2046-3446-2046	2046-4046-2046	2046-5046-2046
	5'-0 1/2"	1850-3450-1850	1850-4050-1850	1850-5050-1850	2050-3450-2050	2050-4050-2050	2050-5050-2050
	5'-6 1/2"	1856-3456-1856	1856-4056-1856	1856-5056-1856	2056-3456-2056	2056-4056-2056	2056-5056-2056
	6'-0 1/2"	1860-3460-1860	1860-4060-1860	1860-5060-1860	2060-3460-2060	2060-4060-2060	2060-5060-2060
	Projection	1'-3 5/32"	1'-3 5/32"	1'-3 5/32"	1'-6"	1'-6"	1'-6"
		7'-0"					
HEIGHT	Rough Opg.	7'-0"	7'-8"	8'-8"	7'-2 7/8"	7'-10 7/8"	8'-10 7/8"
		2'-4" Wide Flanker Units			2'-6" Wide Flanker Units		
		3'-4" Center	4'-0" Center	5'-0" Center	3'-4" Center	4'-0" Center	5'-0" Center
	4'-0 1/2"	2440-3440-2440	2440-4040-2440	2440-5040-2440	2640-3440-2640	2640-4040-2640	2640-5040-2640
	4'-6 1/2"	2446-3446-2446	2446-4046-2446	2446-5046-2446	2646-3446-2646	2646-4046-2646	2646-5046-2646
	5'-0 1/2"	2450-3450-2450	2450-4050-2450	2450-5050-2450	2650-3450-2650	2650-4050-2650	2650-5050-2650
	5'-6 1/2"	2456-3456-2456	2456-4056-2456	2456-5056-2456	2656-3456-2656	2656-4056-2656	2656-5056-2656
	6'-0 1/2"	2460-3460-2460	2460-4060-2460	2460-5060-2460	2660-3460-2660	2660-4060-2660	2660-5060-2660
	Projection	1'-8 13/16"	1'-8 13/16"	1'-8 13/16"	1'-10 7/32"	1'-10 7/32"	1'-10 7/32"

FOR WINDOWS GREATER THAN 30 SQUARE FEET OR RATED HIGHER THAN PG50, ONE OF THESE THREE INSTALLATION METHODS IS REQUIRED:  
A) THROUGH THE JAMB B) ALUMINUM INSTALLATION FLANGE OR C) INSTALLATION CLIPS.  
ADDITIONAL CUSTOM SIZES ARE AVAILABLE. CONTACT YOUR LOCAL SUPPLIER FOR MORE INFORMATION. DRAWINGS ARE NOT TO SCALE.

# BAY & BOW WINDOWS

## 90° Casement Box Bay Window Sizes

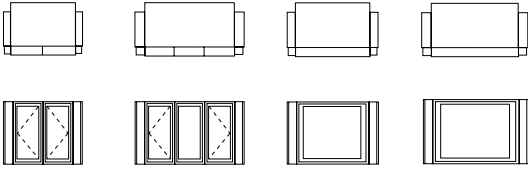

		WIDTH			
		3'-0"	4'-5 3/4"	4'-0 1/2"	5'-0 1/2"
HEIGHT	Rough Openings				
		<b>15 3/4-2 Center</b>	<b>15 3/4 -3 Center</b>	<b>4'-0" Center</b>	<b>5'-0" Center</b>
	3'-0 1/2"	15 3/4 30-2	15 3/4 30-3	4030	5030
	4'-0 1/2"	15 3/4 40-2	15 3/4 40-3	4040	5040
	5'-0 1/2"	15 3/4 50-2	15 3/4 50-3	4050	5050
	Projection	1'-10 7/8"	1'-10 7/8"	1'-10 7/8"	1'-10 7/8"
1'-5 3/4" wide operating casement flankers are standard on all box bay units.					

### NOTES

Projection is measured from the outside of the exterior sheathing to the exterior sheathing line of the outermost unit.

Support is required underneath all bay and bow units. For additional support, we offer a cable support system.

Insulated platforms and brackets are not included.

FOR WINDOWS GREATER THAN 30 SQUARE FEET OR RATED HIGHER THAN PG50, ONE OF THESE THREE INSTALLATION METHODS IS REQUIRED:  
 A) THROUGH THE JAMB B) ALUMINUM INSTALLATION FLANGE OR C) INSTALLATION CLIPS.  
 ADDITIONAL CUSTOM SIZES ARE AVAILABLE. CONTACT YOUR LOCAL SUPPLIER FOR MORE INFORMATION. DRAWINGS ARE NOT TO SCALE.



**3-Wide 10° Casement Bow Windows**

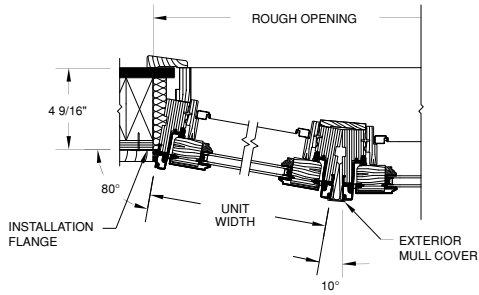

Horizontal Section

**4-Wide 10° Casement Bow Windows**

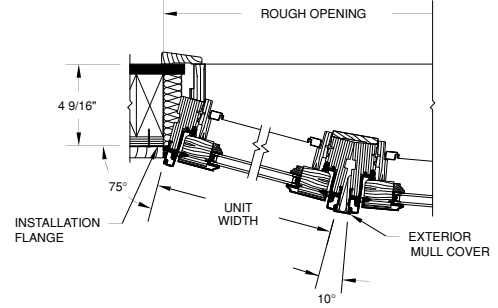

Horizontal Section

**5-Wide 10° Casement Bow Windows**

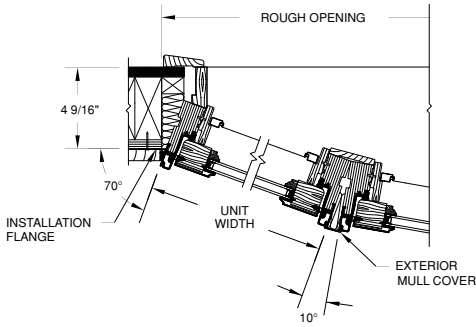

Horizontal Section

**6-Wide 10° Casement Bow Windows**

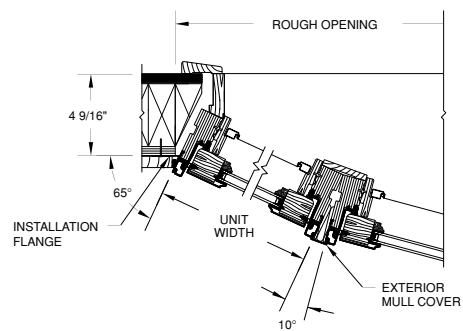

Horizontal Section

**30° Casement Angle Bay Windows**

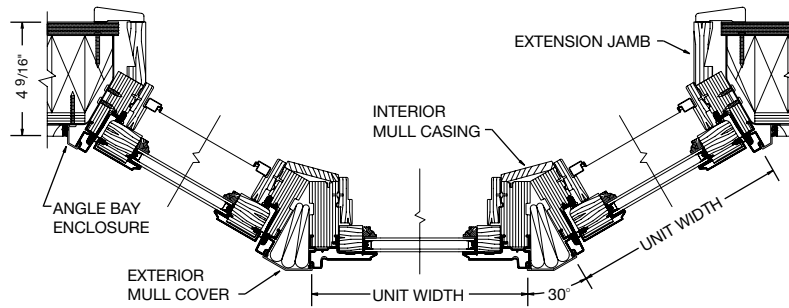

Horizontal Section

Shown with ovolo (colonial) glass stops.

PROPER INSTALLATION AND MAINTENANCE OF E-SERIES PRODUCTS IS ESSENTIAL TO ATTAIN OPTIMUM PERFORMANCE AND OPERATION. WRITTEN INSTALLATION INSTRUCTIONS THAT PROVIDE GUIDELINES FOR PROPER INSTALLATION ARE AVAILABLE BY VISITING [ANDERSENWINDOWS.COM](http://ANDERSENWINDOWS.COM). CUSTOM SIZES ARE AVAILABLE. CONTACT YOUR LOCAL SUPPLIER FOR MORE INFORMATION. DRAWINGS ARE NOT TO SCALE.

# BAY & BOW WINDOWS

## 45° Casement Angle Bay Windows

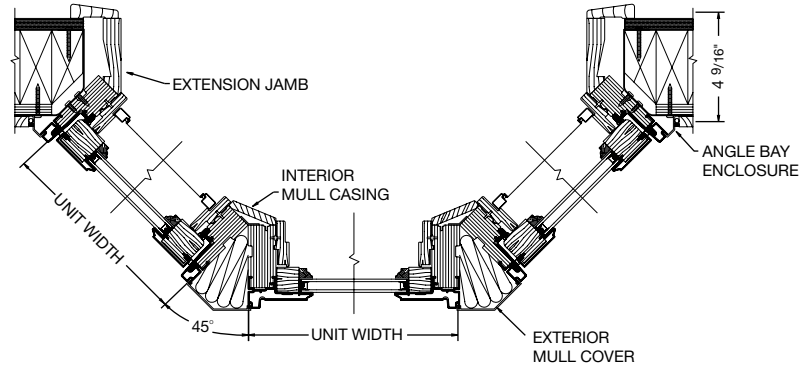

Horizontal Section

## Casement Bay/Bow Windows

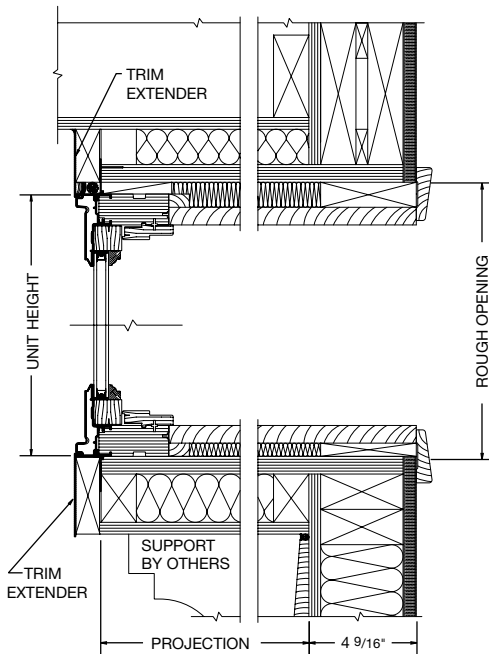

Vertical Section

## 90° Casement Box Bay Windows

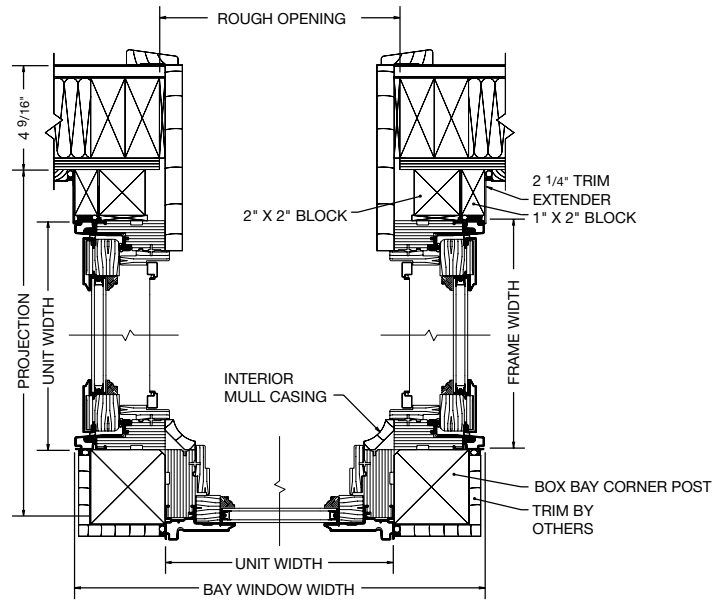

Horizontal Section

Shown with ovolo (colonial) glass stops.

PROPER INSTALLATION AND MAINTENANCE OF E-SERIES PRODUCTS IS ESSENTIAL TO ATTAIN OPTIMUM PERFORMANCE AND OPERATION. WRITTEN INSTALLATION INSTRUCTIONS THAT PROVIDE GUIDELINES FOR PROPER INSTALLATION ARE AVAILABLE BY VISITING [ANDERSENWINDOWS.COM](http://ANDERSENWINDOWS.COM). CUSTOM SIZES ARE AVAILABLE. CONTACT YOUR LOCAL SUPPLIER FOR MORE INFORMATION. DRAWINGS ARE NOT TO SCALE.

### 30° Double-Hung Angle Bay Window Sizes

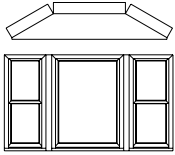

		WIDTH				
		30 Degree Double-Hung Angle Bay Units				
HEIGHT	Rough Opp.	6'-3 11/16"	6'-5 11/16"	6'-7 11/16"	7'-3 11/16"	8'-3 11/16"
		1'-8" Wide Flanker Units				
		3'-0" Center	3'-2" Center	3'-4" Center	4'-0" Center	5'-0" Center
	4'-0 1/2"	1840-3040-1840	1840-3240-1840	1840-3440-1840	1840-4040-1840	1840-5040-1840
	4'-6 1/2"	1846-3046-1846	1846-3246-1846	1846-3446-1846	1846-4046-1846	1846-5046-1846
	4'-9 1/2"	1849-3049-1849	1849-3249-1849	1849-3449-1849	1849-4049-1849	1849-5049-1849
	5'-0 1/2"	1850-3050-1850	1850-3250-1850	1850-3450-1850	1850-4050-1850	1850-5050-1850
	5'-1 1/2"	1851-3051-1851	1851-3251-1851	1851-3451-1851	1851-4051-1851	1851-5051-1851
	5'-6 1/2"	1856-3056-1856	1856-3256-1856	1856-3456-1856	1856-4056-1856	1856-5056-1856
	6'-0 1/2"	1860-3060-1860	1860-3260-1860	1860-3460-1860	1860-4060-1860	1860-5060-1860
	Projection	0'-10 3/4"	0'-10 3/4"	0'-10 3/4"	0'-10 3/4"	0'-10 3/4"
HEIGHT	Rough Opp.	6'-10 5/8"	7'-0 5/8"	7'-2 5/8"	7'-10 5/8"	8'-10 5/8"
		2'-0" Wide Flanker Units				
		3'-0" Center	3'-2" Center	3'-4" Center	4'-0" Center	5'-0" Center
	4'-0 1/2"	2040-3040-2040	2040-3240-2040	2040-3440-2040	2040-4040-2040	2040-5040-2040
	4'-6 1/2"	2046-3046-2046	2046-3246-2046	2046-3446-2046	2046-4046-2046	2046-5046-2046
	4'-9 1/2"	2049-3049-2049	2049-3249-2049	2049-3449-2049	2049-4049-2049	2049-5049-2049
	5'-0 1/2"	2050-3050-2050	2050-3250-2050	2050-3450-2050	2050-4050-2050	2050-5050-2050
	5'-1 1/2"	2051-3051-2051	2051-3251-2051	2051-3451-2051	2051-4051-2051	2051-5051-2051
	5'-6 1/2"	2056-3056-2056	2056-3256-2056	2056-3456-2056	2056-4056-2056	2056-5056-2056
	6'-0 1/2"	2060-3060-2060	2060-3260-2060	2060-3460-2060	2060-4060-2060	2060-5060-2060
	Projection	1'-0 3/4"	1'-0 3/4"	1'-0 3/4"	1'-0 3/4"	1'-0 3/4"
HEIGHT	Rough Opp.	7'-5 1/2"	7'-7 1/2"	7'-9 1/2"	8'-5 1/2"	9'-5 1/2"
		2'-4" Wide Flanker Units				
		3'-0" Center	3'-2" Center	3'-4" Center	4'-0" Center	5'-0" Center
	4'-0 1/2"	2440-3040-2440	2440-3240-2440	2440-3440-2440	2440-4040-2440	2440-5040-2440
	4'-6 1/2"	2446-3046-2446	2446-3246-2446	2446-3446-2446	2446-4046-2446	2446-5046-2446
	4'-9 1/2"	2449-3049-2449	2449-3249-2449	2449-3449-2449	2449-4049-2449	2449-5049-2449
	5'-0 1/2"	2450-3050-2450	2450-3250-2450	2450-3450-2450	2450-4050-2450	2450-5050-2450
	5'-1 1/2"	2451-3051-2451	2451-3251-2451	2451-3451-2451	2451-4051-2451	2451-5051-2451
	5'-6 1/2"	2456-3056-2456	2456-3256-2456	2456-3456-2456	2456-4056-2456	2456-5056-2456
	6'-0 1/2"	2460-3060-2460	2460-3260-2460	2460-3460-2460	2460-4060-2460	2460-5060-2460
	Projection	1'-2 3/4"	1'-2 3/4"	1'-2 3/4"	1'-2 3/4"	1'-2 3/4"

**NOTES**

Projection is measured from the outside of the exterior sheathing to the exterior sheathing line of the outermost unit.

Support is required underneath all bay and bow units. For additional support, we offer a cable support system.

Insulated platforms and brackets are not included.

FOR WINDOWS GREATER THAN 30 SQUARE FEET OR RATED HIGHER THAN PG50, ONE OF THESE THREE INSTALLATION METHODS IS REQUIRED:  
A) THROUGH THE JAMB B) ALUMINUM INSTALLATION FLANGE OR C) INSTALLATION CLIPS.  
ADDITIONAL CUSTOM SIZES ARE AVAILABLE. CONTACT YOUR LOCAL SUPPLIER FOR MORE INFORMATION. DRAWINGS ARE NOT TO SCALE.

# BAY & BOW WINDOWS

## 45° Double-Hung Angle Bay Window Sizes

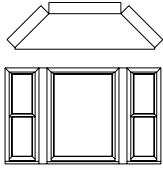

		WIDTH				
		45 Degree Double-Hung Angle Bay Units				
Rough Opg.		5'-11 1/16"	6'-1 1/16"	6'-3 1/16"	6'-11 1/16"	7'-11 1/16"
			1'-8" Wide Flanker Units			
		3'-0" Center	3'-2" Center	3'-4" Center	4'-0" Center	5'-0" Center
4'-0 1/2"		1840-3040-1840	1840-3240-1840	1840-3440-1840	1840-4040-1840	1840-5040-1840
4'-6 1/2"		1846-3046-1846	1846-3246-1846	1846-3446-1846	1846-4046-1846	1846-5046-1846
4'-9 1/2"		1849-3049-1849	1849-3249-1849	1849-3449-1849	1849-4049-1849	1849-5049-1849
5'-0 1/2"		1850-3050-1850	1850-3250-1850	1850-3450-1850	1850-4050-1850	1850-5050-1850
5'-1 1/2"		1851-3051-1851	1851-3251-1851	1851-3451-1851	1851-4051-1851	1851-5051/1851
5'-6 1/2"		1856-3056-1856	1856-3256-1856	1856-3456-1856	1856-4056-1856	1856-5056-1856
6'-0 1/2"		1860-3060-1860	1860-3260-1860	1860-3460-1860	1860-4060-1860	1860-5060-1860
Projection		1'-3 11/16"	1'-3 11/16"	1'-3 11/16"	1'-3 11/16"	1'-3 11/16"
Rough Opg.		6'-4 3/4"	6'-6 3/4"	6'-8 3/4"	7'-4 3/4"	8'-4 3/4"
		2'-0" Wide Flanker Units				
		3'-0" Center	3'-2" Center	3'-4" Center	4'-0" Center	5'-0" Center
4'-0 1/2"		2040-3040-2040	2040-3240-2040	2040-3440-2040	2040-4040-2040	2040-5040-2040
4'-6 1/2"		2046-3046-2046	2046-3246-2046	2046-3446-2046	2046-4046-2046	2046-5046-2046
4'-9 1/2"		2049-3049-2049	2049-3249-2049	2049-3449-2049	2049-4049-2049	2049-5049-2049
5'-0 1/2"		2050-3050-2050	2050-3250-2050	2050-3450-2050	2050-4050-2050	2050-5050-2050
5'-1 1/2"		2051-3051-2051	2051-3251-2051	2051-3451-2051	2051-4051-2051	2051-5051-2051
5'-6 1/2"		2056-3056-2056	2056-3256-2056	2056-3456-2056	2056-4056-2056	2056-5056-2056
6'-0 1/2"		2060-3060-2060	2060-3260-2060	2060-3460-2060	2060-4060-2060	2060-5060-2060
Projection		1'-6 1/2"	1'-6 1/2"	1'-6 1/2"	1'-6 1/2"	1'-6 1/2"
Rough Opg.		6'-10 3/8"	7'-0 3/8"	7'-2 3/8"	7'-10 3/8"	8'-10 3/8"
		2'-4" Wide Flanker Units				
		3'-0" Center	3'-2" Center	3'-4" Center	4'-0" Center	5'-0" Center
4'-0 1/2"		2440-3040-2440	2440-3240-2440	2440-3440-2440	2440-4040-2440	2440-5040-2440
4'-6 1/2"		2446-3046-2446	2446-3246-2446	2446-3446-2446	2446-4046-2446	2446-5046-2446
4'-9 1/2"		2449-3049-2449	2449-3249-2449	2449-3449-2449	2449-4049-2449	2449-5049-2449
5'-0 1/2"		2450-3050-2450	2450-3250-2450	2450-3450-2450	2450-4050-2450	2450-5050-2450
5'-1 1/2"		2451-3051-2451	2451-3251-2451	2451-3451-2451	2451-4051-2451	2451-5051-2451
5'-6 1/2"		2456-3056-2456	2456-3256-2456	2456-3456-2456	2456-4056-2456	2456-5056-2456
6'-0 1/2"		2460-3060-2460	2460-3260-2460	2460-3460-2460	2460-4060-2460	2460-5060-2460
Projection		1'-9 11/32"	1'-9 11/32"	1'-9 11/32"	1'-9 11/32"	1'-9 11/32"

FOR WINDOWS GREATER THAN 30 SQUARE FEET OR RATED HIGHER THAN PG50, ONE OF THESE THREE INSTALLATION METHODS IS REQUIRED:  
 A) THROUGH THE JAMB B) ALUMINUM INSTALLATION FLANGE OR C) INSTALLATION CLIPS.  
 ADDITIONAL CUSTOM SIZES ARE AVAILABLE. CONTACT YOUR LOCAL SUPPLIER FOR MORE INFORMATION. DRAWINGS ARE NOT TO SCALE.

**30° Double-Hung Angle Bay Windows**

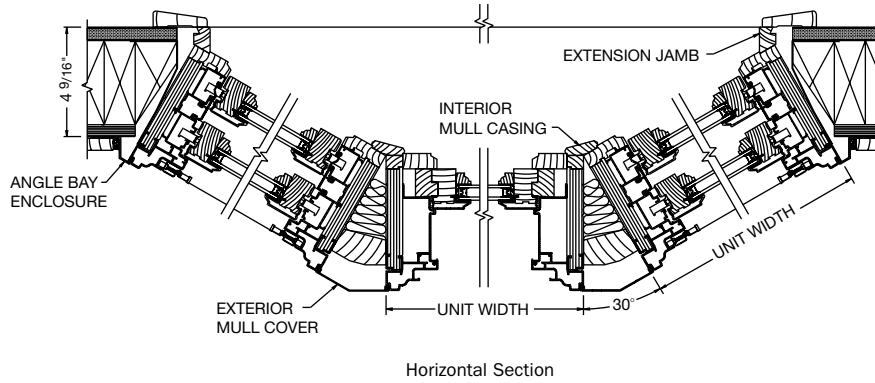

**Double-Hung Angle Bay Windows**

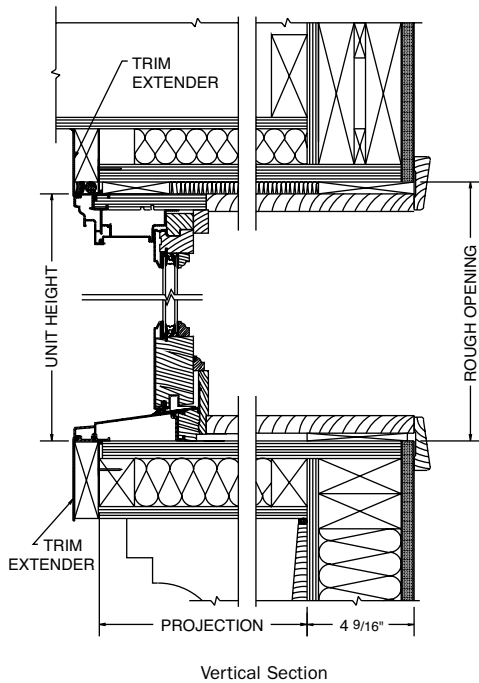

**45° Double-Hung Angle Bay Windows**

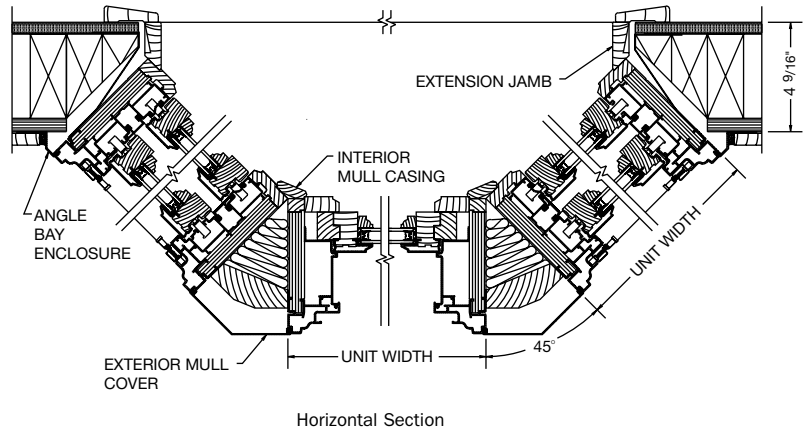

E-Series Bay & Bow Windows

Shown with ovolo (colonial) glass stops.

PROPER INSTALLATION AND MAINTENANCE OF E-SERIES PRODUCTS IS ESSENTIAL TO ATTAIN OPTIMUM PERFORMANCE AND OPERATION. WRITTEN INSTALLATION INSTRUCTIONS THAT PROVIDE GUIDELINES FOR PROPER INSTALLATION ARE AVAILABLE BY VISITING [ANDERSENWINDOWS.COM](http://ANDERSENWINDOWS.COM). CUSTOM SIZES ARE AVAILABLE. CONTACT YOUR LOCAL SUPPLIER FOR MORE INFORMATION. DRAWINGS ARE NOT TO SCALE.

# GLIDING WINDOWS

Functionality is the key to our gliding window. Efficient space utilization and sleek lines make this window the right choice for that tight, hard-to-manage space. With two or three sash systems all in one frame and discreet hardware creating clear, unobstructed views, these windows offer a cost-effective design with modern efficiencies.

---

<b>Gliding Overview</b> .....	<b>94</b>
Sizing	
Gliding 2-Sash .....	96
Gliding 3-Sash .....	96
Details .....	97
Installation Materials .....	154
Product Performance .....	158





# GLIDING WINDOWS

## FEATURES

### GLIDING WINDOWS

#### FRAME & SASH

**A** Select wood components are kiln dried and treated with water/insect repellent and preservative. Interior wood surfaces are available in pine, mixed grain Douglas fir, cherry, hickory, mahogany\*, maple, oak, walnut, alder or vertical grain Douglas fir. Interior surfaces are available unfinished or factory primed. Factory-applied finishes are available in a variety of stain and paint options.

**B** Wood components are fitted with aluminum extrusions on the exterior. 50 exterior colors that meet AAMA 2604 and 2605 specifications are available, as well as custom colors. Also available is a selection of seven exterior anodized options.

**C** The frame consists of a rigid vinyl head and sill track. The compression-style head track helps create a positive seal between the sash and frame.

Vinyl installation flanges are pre-applied into a kerf on the frame exterior to facilitate installation. Optional aluminum flanges or metal installation clips are available.

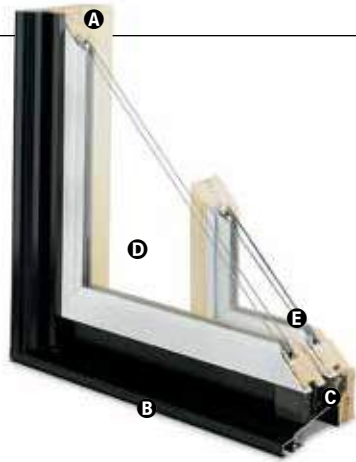

Compression foam-filled bulb weatherstrip is applied on the sill for maximum resistance to water and air infiltration. Outside and inside sash are sealed with a compression bulb weatherstrip at the meeting stile.

#### GLASS

**D** High-Performance Low-E4® glass with a low-conductivity spacer. Triple-pane glass, tinted, clear dual-pane, high-altitude glass and other special glazing options are available.

**E** Glass is fixed in place from the interior with wood stops that can be removed for easy reglazing if necessary. Glass stops available in ovolo (colonial) and contemporary profiles.

#### HARDWARE

Sash locks and keepers give a slim, more traditional design and allow easy opening.

Slim Line sash pulls allow easy operation and do not interfere with window coverings.

### HARDWARE OPTIONS



Lock

Antique Brass | **Black** | Bright Chrome  
Bronze | Gold | Oil Rubbed Bronze  
Pewter | Polished Brass  
Satin Chrome | White

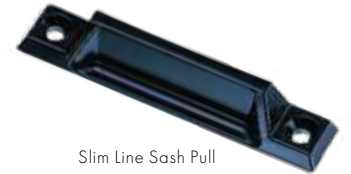

Slim Line Sash Pull

Standard: **Black** | Bronze  
Gold | White  
Optional: Polished Brass

Bold name denotes finish shown.

#### HARDWARE FINISHES



Oil rubbed bronze is a "living" finish that will change with time and use.

## EXTERIOR & INTERIOR OPTIONS

**EXTERIOR COLORS** 50 exterior colors, 7 anodized finishes and custom colors. See exterior colors on page 11.

#### INTERIOR WOOD SPECIES

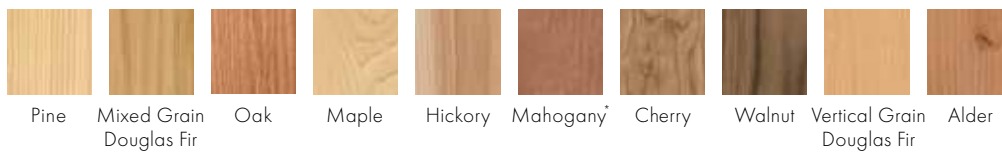

Naturally occurring variations in grain, color and texture of wood make each window one of a kind.

All factory-finished options are shown on pine.

Painted options available on pine. Dark bronze and black painted options available on pine or maple. Anodized silver painted option available on maple only.

Interior custom stains, paints and color matching available.

#### FACTORY-FINISHED INTERIORS

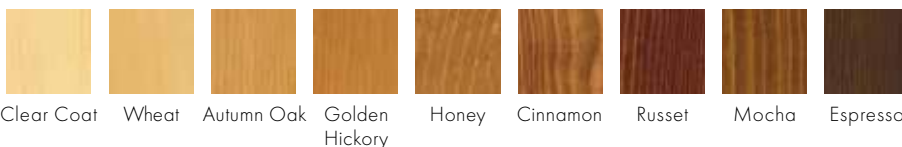

#### INTERIOR PAINTED OPTIONS

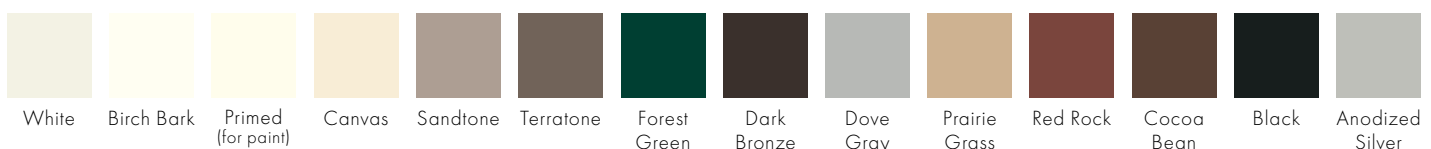

\*Actual wood species is either Sapele or Sipo, both non-endangered species grown in Africa, with color and characteristics similar to Central American mahoganies. Printing limitations prevent exact replication of colors and finishes. Please see your Andersen supplier for actual color and finish samples.



**ACCESSORIES** Sold Separately

**GLIDING WINDOWS**

**INSECT SCREENS**

**Conventional Insect Screens**



Charcoal fiberglass screen mesh fits into an aluminum frame in all 50 exterior colors. Aluminum screen mesh is available as an option.

**TruScene® Insect Screens**

TruScene insect screens available in all 50 exterior colors and seven anodized finishes.

See page 24 for more information on our insect screen options.

**SENSORS**

**VeriLock® Security Sensors**



VeriLock sensors are unique as they detect whether the windows are locked or unlocked — a feature no other sensors can provide. See page 27 for Smart Home options.

**Open/Closed Sensors**

Wireless open/closed sensors are available in four colors. See page 27 for details.

**GRILLES**

**Full Divided Light**

Permanent interior and exterior grilles with grille spacer bars between two panes of glass. Available in 5/8", 7/8", 1 1/8", 1 1/2", or 2 1/4" widths. Interior grilles are available with ovolo or contemporary profile (ovolo profile shown below). Not all widths are shown.



**Simulated Divided Light**

Permanent exterior and interior grilles without grille spacer bars. Available in 5/8", 7/8", 1 1/8", 1 1/2", or 2 1/4" widths. Interior grilles are available with ovolo or contemporary profile (ovolo profile shown below). Not all widths are shown.



**Finelight™**

**Grilles-Between-the-Glass**

Available in 5/8" flat or 1" contoured aluminum profiles. Two-tone colors of pebble tan/colony white, sierra bronze/colony white or forest green/colony white are available on the 1" profile.



**Removable Interior Wood Grilles**

Removable interior wood grilles are available in a 7/8" width and ovolo or contemporary profiles. Optional surround for removable grille and permanent exterior grilles also available.



See page 22 for more information on grilles.

# GLIDING WINDOWS

## 2-Sash Gliding Window Sizes

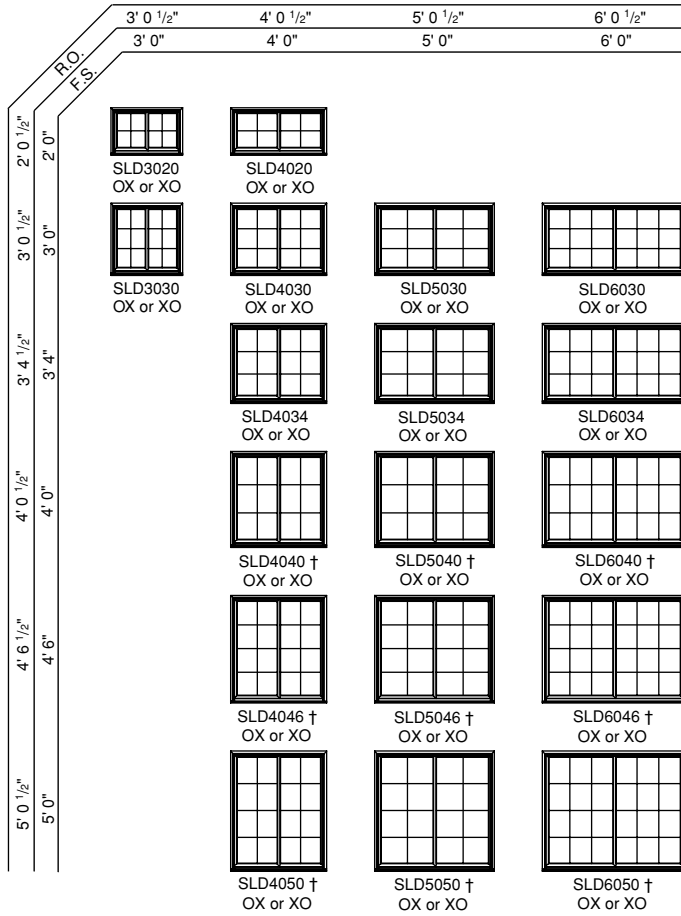

## 3-Sash Gliding Window Sizes

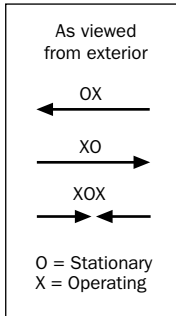
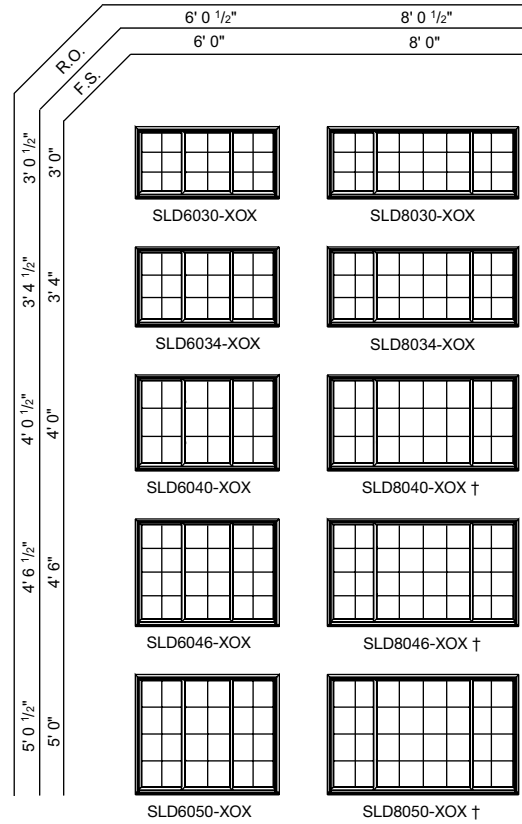

### NOTES

† These units meet or exceed the following dimensions: Clear Opening Area 5.7 sq. ft., Clear Opening Height 24" and 44" maximum floor to sill height (with standard 6' 10-1/2" structural header height). See your local code official for requirements in your area.

3-sash gliding units use 2'0" operating sash as a standard. Additional sash ratios also available.

If glass is positioned within 18" of the finished floor, safety/tempered glass may be required. Local codes may differ. Verify tempered glass requirements with your local building code official.

Use structural joining material when necessary or required by code.

The light patterns illustrated apply to rectangular removable interior wood grilles, Full Divided Light, Simulated Divided Light, Decorelle 100, 150 and 400 and Finelight™ Grilles-Between-the-Glass. All removable interior wood grilles will be installed in the units unless otherwise specified.

For a metric conversion in millimeters, multiply dimensions in inches by 25.4.

**FOR WINDOWS GREATER THAN 30 SQUARE FEET OR RATED HIGHER THAN PG50, ONE OF THESE THREE INSTALLATION METHODS IS REQUIRED:  
A) THROUGH THE JAMB B) ALUMINUM INSTALLATION FLANGE OR C) INSTALLATION CLIPS.  
ADDITIONAL CUSTOM SIZES ARE AVAILABLE. CONTACT YOUR LOCAL SUPPLIER FOR MORE INFORMATION. DRAWINGS ARE NOT TO SCALE.**

**2-Sash Gliding Windows**

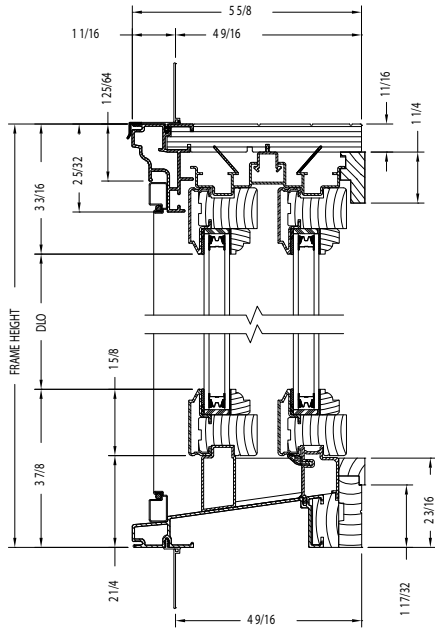

Vertical Section

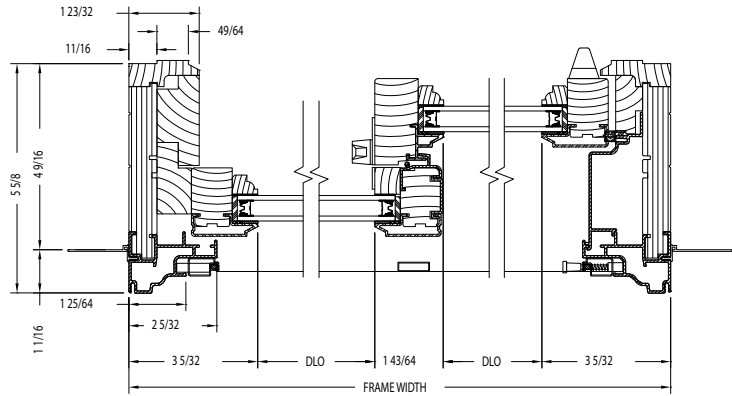

Horizontal Section

Shown with ovolo (colonial) glass stops.

**3-Sash Gliding Windows**

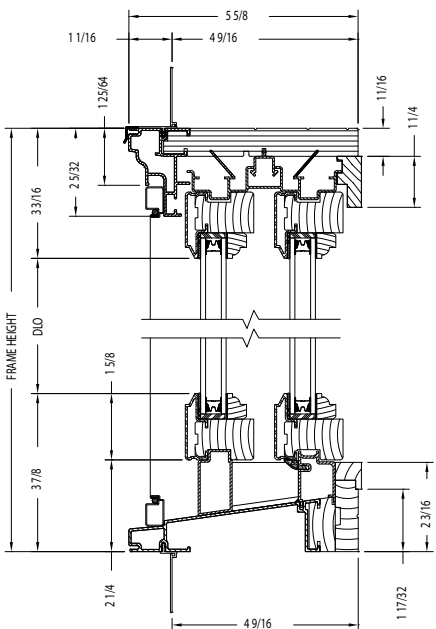

Vertical Section

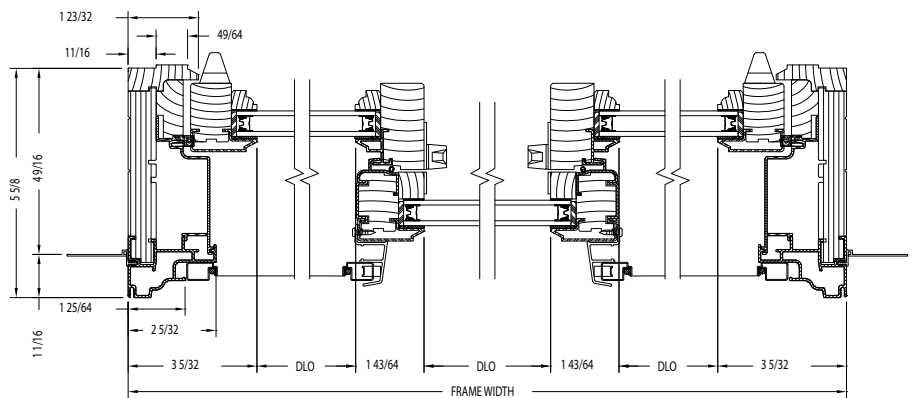

Horizontal Section

Shown with ovolo (colonial) glass stops.

PROPER INSTALLATION AND MAINTENANCE OF E-SERIES PRODUCTS IS ESSENTIAL TO ATTAIN OPTIMUM PERFORMANCE AND OPERATION. WRITTEN INSTALLATION INSTRUCTIONS THAT PROVIDE GUIDELINES FOR PROPER INSTALLATION ARE AVAILABLE BY VISITING [ANDERSENWINDOWS.COM](http://ANDERSENWINDOWS.COM). CUSTOM SIZES ARE AVAILABLE. CONTACT YOUR LOCAL SUPPLIER FOR MORE INFORMATION. DRAWINGS ARE NOT TO SCALE.

# SPECIALTY WINDOWS

Our made-to-order philosophy lets you be creative with your look. Design your very own window using basic or unique shapes and add decorative glass for a creative accent. Our specialty profiles even complement double-hung and casement details for ultimate design flexibility.

---

<b>Specialty Overview</b> .....	<b>100</b>
Shapes .....	102
Sizing	
Half Circle .....	103
Quarter Circle .....	104
Circle & Oval .....	104
Details .....	105
Installation Materials .....	154
Product Performance .....	158





# SPECIALTY WINDOWS

## FEATURES

### SPECIALTY WINDOWS

#### FRAME & SASH

**A** Select wood components are kiln dried and treated with water/insect repellent and preservative. Interior wood surfaces are available in pine, mixed grain Douglas fir, cherry, hickory, mahogany\*, maple, oak, walnut, alder or vertical grain Douglas fir. Interior surfaces are available unfinished or factory primed. Factory-applied finishes are available in a variety of stain and paint options.

**B** Wood components are fitted with aluminum extrusions on the exterior. 50 exterior colors that meet AAMA 2604 and 2605 specifications are available, as well as custom colors. Also available is a selection of seven exterior anodized options.

Vinyl installation flanges are pre-applied into a kerf on the frame exterior to facilitate installation. Optional aluminum flanges or metal installation clips are available.

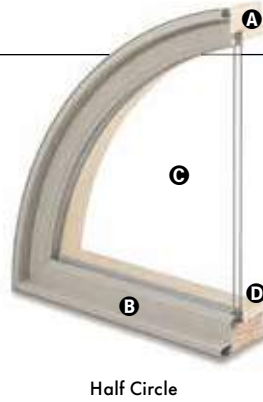

Half Circle

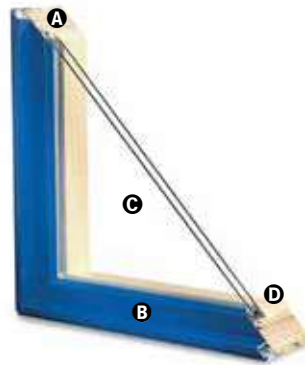

Geometric Specialty



Double-Hung Specialty

In addition to our standard profile, a double-hung specialty frame profile is also available for half circle and geometric specialty windows.

#### GLASS

**C** High-Performance Low-E4® glass with a low-conductivity spacer. Triple-pane glass, tinted, clear dual-pane, high-altitude glass and other special glazing options are available.

**D** Glass is fixed in place from the interior with wood stops that can be removed for easy reglazing if necessary. Glass stops available in ovolo (colonial) and contemporary profiles.

## EXTERIOR & INTERIOR OPTIONS

**EXTERIOR COLORS** 50 exterior colors, 7 anodized finishes and custom colors. See exterior colors on page 11.

#### INTERIOR WOOD SPECIES

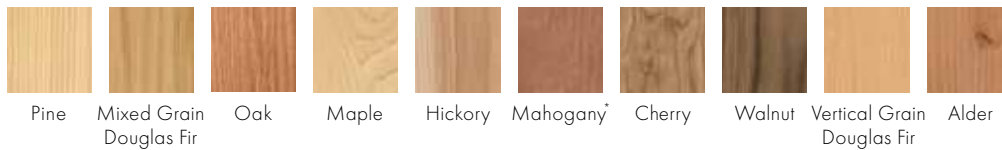

Naturally occurring variations in grain, color and texture of wood make each window one of a kind.

All factory-finished options are shown on pine.

Painted options available on pine. Dark bronze and black painted options available on pine or maple.

Anodized silver painted option available on maple only.

Interior custom stains, paints and color matching available.

#### FACTORY-FINISHED INTERIORS

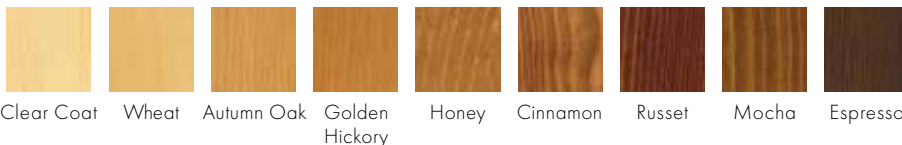

#### INTERIOR PAINTED OPTIONS

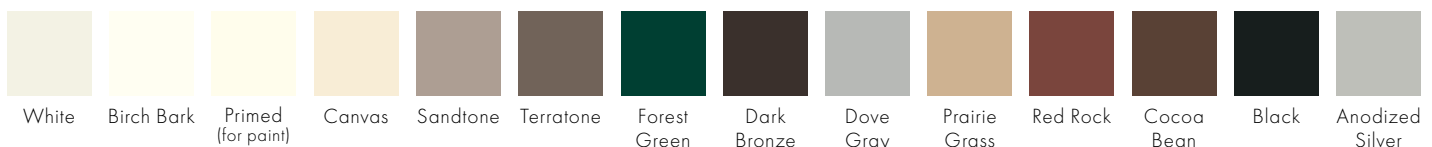

\*Actual wood species is either Sapele or Sipo, both non-endangered species grown in Africa, with color and characteristics similar to Central American mahoganies. Printing limitations prevent exact replication of colors and finishes. Please see your Andersen supplier for actual color and finish samples.

**ACCESSORIES** Sold Separately

**SPECIALTY WINDOWS**

**PRIVACY OPTIONS**

**Blinds-Between-the-Glass**



A 5/8" aluminum slat blind is encased between two panes of insulated glass in a dust-free environment (rectangular shapes only). Available colors are white, tan and almond. Blind can be tilted or raised and lowered with the use of one cord (not all sizes are retractable).

**System 3 Blinds**



A 5/8" aluminum slat blind is mounted to an extruded aluminum blind panel and applied to the window, creating a triple-glazed window boasting privacy and energy efficiency. Available in three colors. Blind panels are offered in white, tan, gold or an optional wood veneer to match your interior.

**System 3 Shades**

Pleated fabric shades are available in four colors to effortlessly and beautifully filter the light. See page 25 for more details.

**GRILLES**

**Full Divided Light**

Permanent interior and exterior grilles with grille spacer bars between two panes of glass. Available in 5/8", 7/8", 1 1/8", 1 1/2", or 2 1/4" widths. Interior grilles are available with ovolo or contemporary profile (ovolo profile shown below). Not all widths are shown.



5/8"

7/8"



1 1/8"

1 1/2"

**Simulated Divided Light**

Permanent exterior and interior grilles without grille spacer bars. Available in 5/8", 7/8", 1 1/8", 1 1/2", or 2 1/4" widths. Interior grilles are available with ovolo or contemporary profile (ovolo profile shown below). Not all widths are shown.



7/8"

**Finelight™**

**Grilles-Between-the-Glass**

Available in 5/8" flat or 1" contoured aluminum profiles. Two-tone colors of pebble tan/colony white, sierra bronze/colony white or forest green/colony white are available on the 1" profile.



5/8" Flat

1" Contoured

**Removable Interior Wood Grilles**

Removable interior wood grilles are available in a 7/8" width and ovolo or contemporary profiles. Optional surround for removable grille and permanent exterior grilles also available.



7/8"

See page 22 for more information on grilles.

# SPECIALTY WINDOWS

## Specialty Shapes

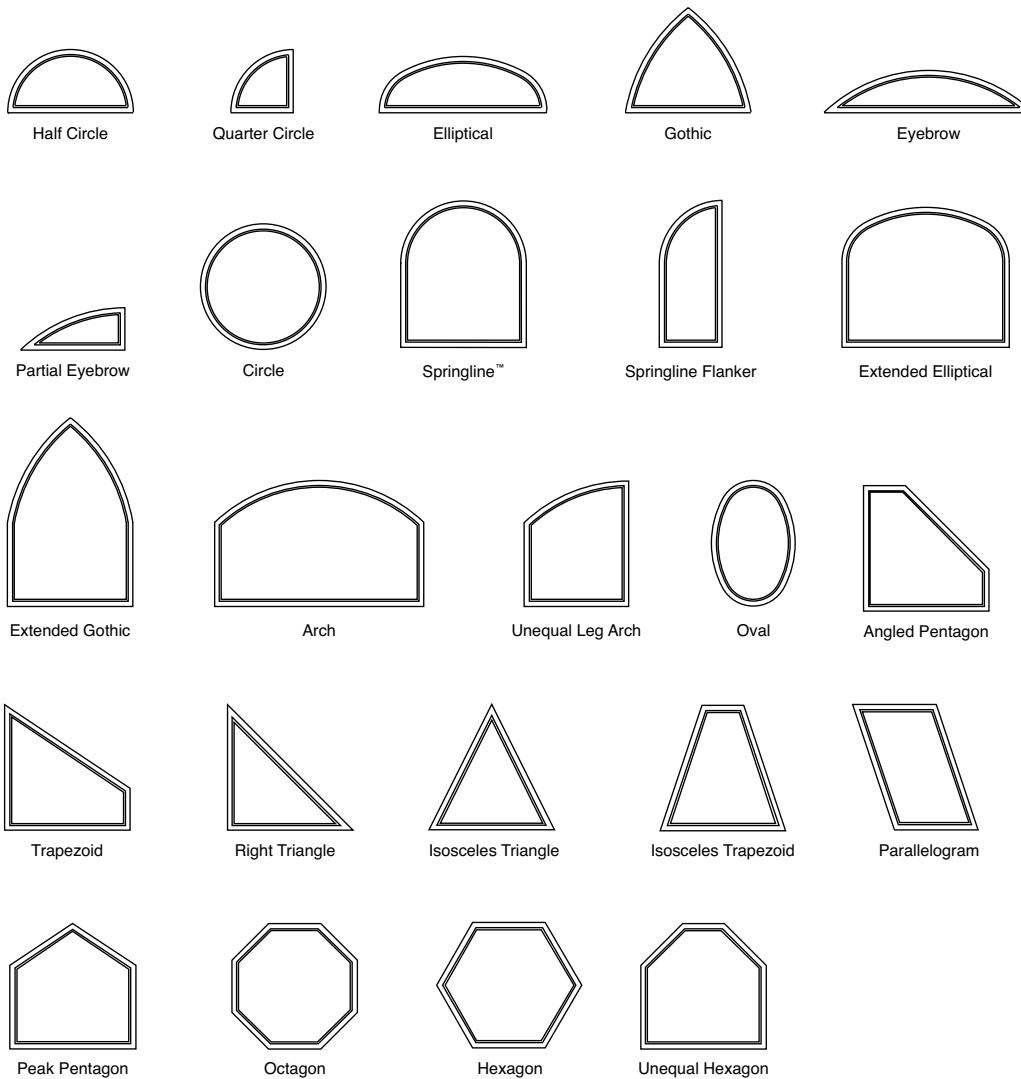

### NOTES

The following general guidelines do not apply to every specialty shape. Contact your local supplier for specific limitations of the specialty shapes shown above or about creating custom shapes beyond those shown here.

Overall unit block size should not be larger than 50 sq. ft.

Frame width and height must be between 9" and 144".

Units can only be larger than 82" in one direction.

Corners/angles cannot be less than 27°.

Standard radiuses include:

1' 0"	3' 0"	7' 0"
1' 2"	3' 1"	7' 6"
1' 3"	3' 3"	8' 0"
1' 4"	3' 4"	9' 0"
1' 6"	3' 6"	10' 7"
1' 6-23/32"	3' 9"	12' 0"
1' 8"	4' 0"	13' 8"
1' 10"	4' 6"	15' 0"
2' 0"	5' 0"	16' 0"
2' 4"	5' 6"	17' 10"
2' 6"	6' 0"	19' 8"
2' 8"	6' 6"	
2' 10-19/32"		

**FOR WINDOWS GREATER THAN 30 SQUARE FEET OR RATED HIGHER THAN PG50, ONE OF THESE THREE INSTALLATION METHODS IS REQUIRED:  
A) THROUGH THE JAMB B) ALUMINUM INSTALLATION FLANGE OR C) INSTALLATION CLIPS.  
ADDITIONAL CUSTOM SIZES ARE AVAILABLE. CONTACT YOUR LOCAL SUPPLIER FOR MORE INFORMATION. DRAWINGS ARE NOT TO SCALE.**



**Half Circle Window Sizes**

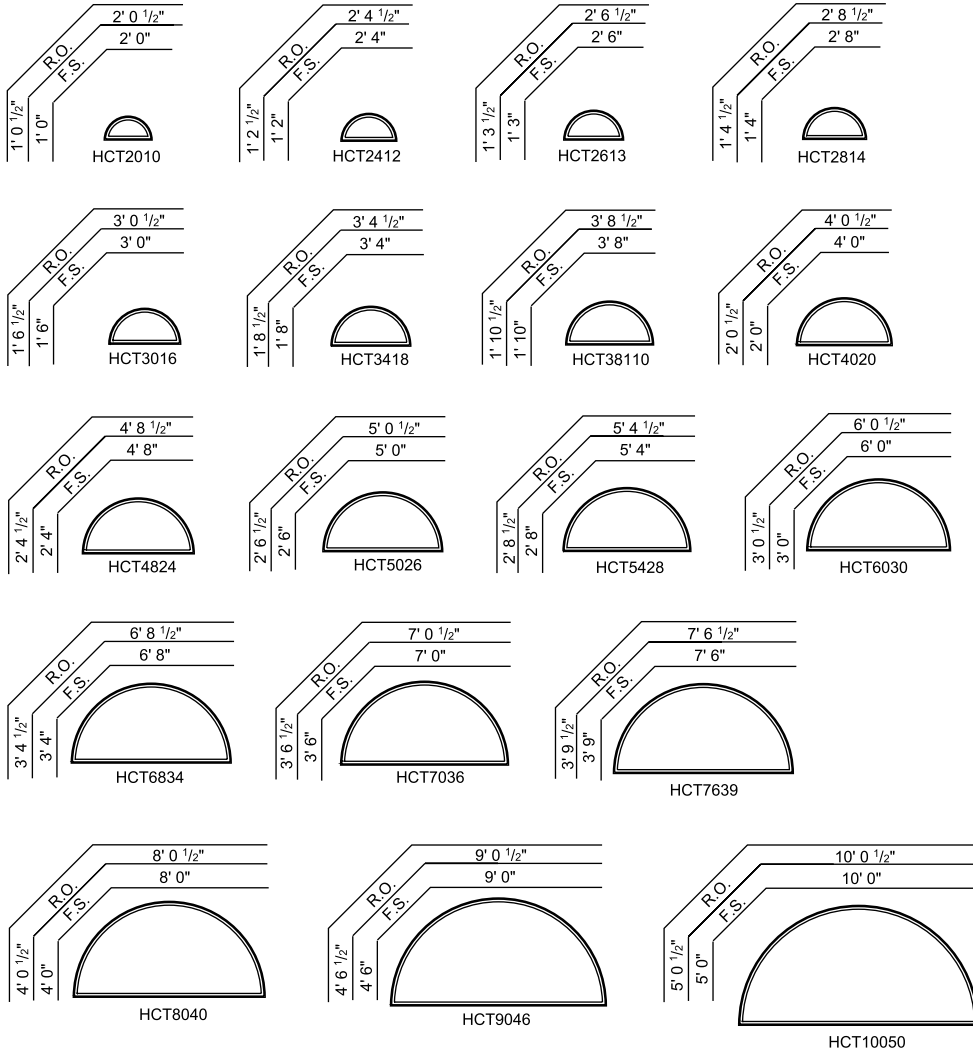

**NOTES**

If glass is positioned within 18" of the finished floor, safety/tempered glass may be required. Local codes may differ. Verify tempered glass requirements with your local building code official.

Use structural joining material when necessary or required by code.

Some limitations exist for light patterns for removable interior wood grilles, Full Divided Light, Simulated Divided Light, Decorelle 100, 150 and 400 and Finelight™ Grilles-Between-the-Glass. Please contact your local supplier for more information. All removable interior wood grilles will be installed in the units unless otherwise specified.

For a metric conversion in millimeters, multiply dimensions in inches by 25.4.

**FOR WINDOWS GREATER THAN 30 SQUARE FEET OR RATED HIGHER THAN PG50, ONE OF THESE THREE INSTALLATION METHODS IS REQUIRED:  
A) THROUGH THE JAMB B) ALUMINUM INSTALLATION FLANGE OR C) INSTALLATION CLIPS.  
ADDITIONAL CUSTOM SIZES ARE AVAILABLE. CONTACT YOUR LOCAL SUPPLIER FOR MORE INFORMATION. DRAWINGS ARE NOT TO SCALE.**

# SPECIALTY WINDOWS

## Quarter Circle Window Sizes

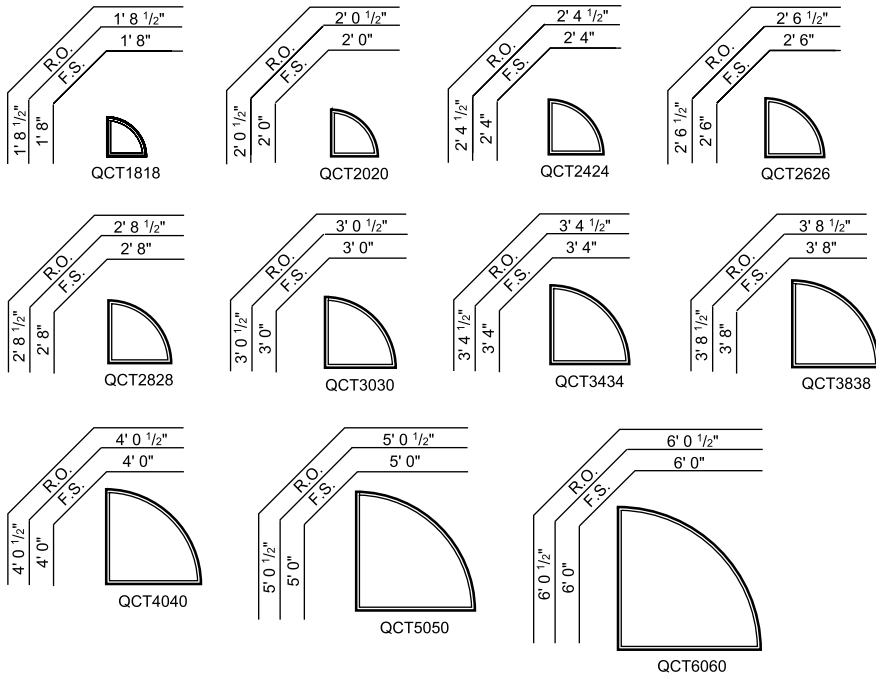

## Circle Window Sizes

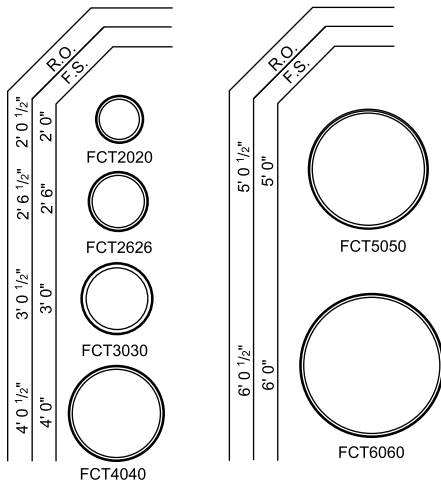

## Oval Window Sizes

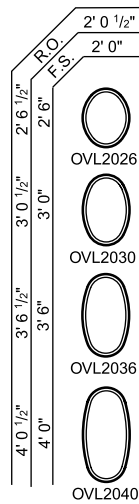

### NOTES

If glass is positioned within 18" of the finished floor, safety/tempered glass may be required. Local codes may differ. Verify tempered glass requirements with your local building code official.

Use structural joining material when necessary or required by code.

Some limitations exist for light patterns for removable interior wood grilles, Full Divided Light, Simulated Divided Light, Decorelle 100, 150 and 400 and Finelight™ Grilles-Between-the-Glass. Please contact your local supplier for more information. All wood grilles will be installed in the units unless otherwise specified.

For a metric conversion in millimeters, multiply dimensions in inches by 25.4.

**FOR WINDOWS GREATER THAN 30 SQUARE FEET OR RATED HIGHER THAN PG50, ONE OF THESE THREE INSTALLATION METHODS IS REQUIRED:  
A) THROUGH THE JAMB B) ALUMINUM INSTALLATION FLANGE OR C) INSTALLATION CLIPS.  
ADDITIONAL CUSTOM SIZES ARE AVAILABLE. CONTACT YOUR LOCAL SUPPLIER FOR MORE INFORMATION. DRAWINGS ARE NOT TO SCALE.**

**Specialty Windows**

**Specialty**

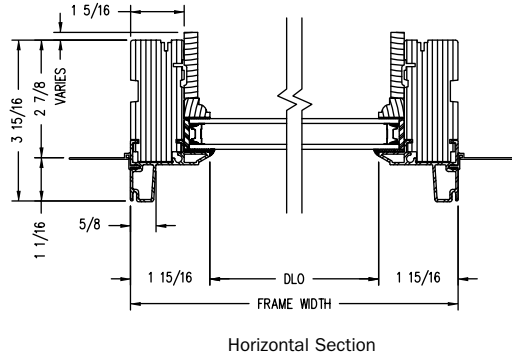
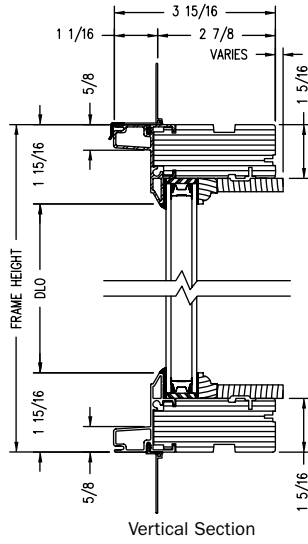

**Specialty  
(Double-Hung  
Frame Profile)**

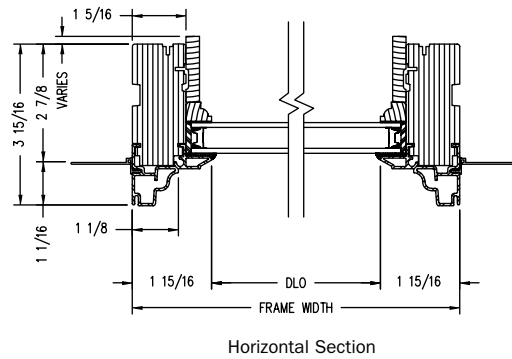
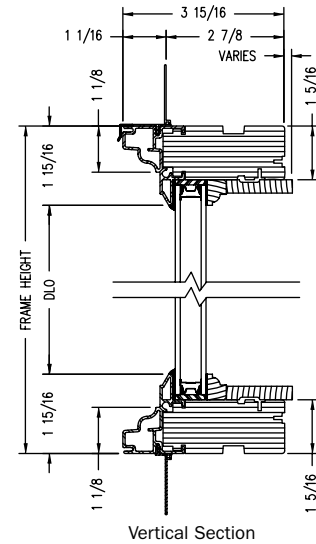

**Exterior  
Glazed  
Specialty**

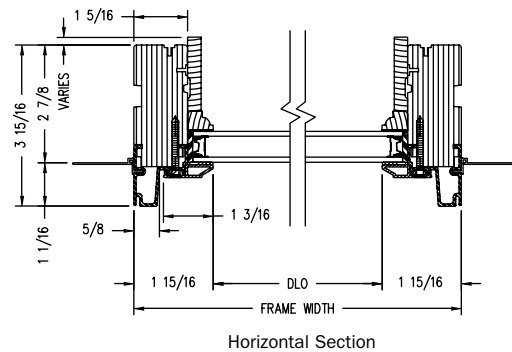
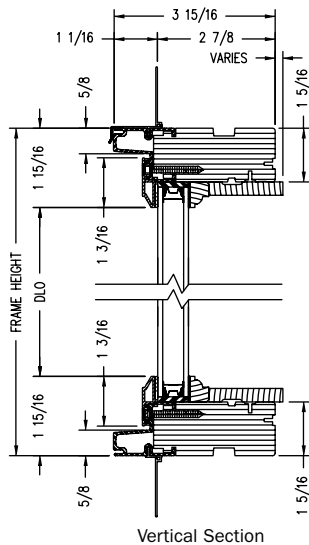

PROPER INSTALLATION AND MAINTENANCE OF E-SERIES PRODUCTS IS ESSENTIAL TO ATTAIN OPTIMUM PERFORMANCE AND OPERATION. WRITTEN INSTALLATION INSTRUCTIONS THAT PROVIDE GUIDELINES FOR PROPER INSTALLATION ARE AVAILABLE BY VISITING [ANDERSENWINDOWS.COM](http://ANDERSENWINDOWS.COM). CUSTOM SIZES ARE AVAILABLE. CONTACT YOUR LOCAL SUPPLIER FOR MORE INFORMATION. DRAWINGS ARE NOT TO SCALE.

# HINGED PATIO DOORS

Bottom and intermediate rail options are just the start to this door’s solid design. Select contemporary or French styling, go as high as 10 feet, add venting inswing or outswing sidelights or raised solid wood panel inserts and create a truly custom look.

---

<b>Hinged Overview</b> .....	<b>108</b>
Panel Labeling .....	112
Panel Handing.....	116, 132
Inswing Sizing	
Single Panel Doors .....	118
Two-Panel Doors .....	119
Sash-Set & Direct-Set Sidelights .....	120
Sash-Set Transom .....	121
Specialty Transom .....	122
Direct-Set Transom .....	123
Arch Doors.....	125
Inswing Details .....	127
Outswing Sizing	
Two-Panel Doors .....	133
Single Panel Doors & Sash-Set Sidelights.....	134
Sash-Set Transom .....	135
Direct-Set & Specialty Transom .....	136
Arch Doors.....	137
Concealed Panic System Sizing .....	138
Outswing Details.....	139
Installation Materials .....	154
Product Performance .....	158





# HINGED PATIO DOORS

## FEATURES

### HINGED PATIO DOORS

#### FRAME & PANEL

**A** Select wood components are kiln dried and treated with water/insect repellent and preservative. Interior wood surfaces are available in pine, mixed grain Douglas fir, cherry, hickory, mahogany\*, maple, oak, walnut, alder or vertical grain Douglas fir. Interior surfaces are available unfinished or factory primed. Factory-applied finishes are available in a variety of stain and paint options.

**B** Wood components are fitted with aluminum extrusions on the exterior. 50 exterior colors that meet AAMA 2604 and 2605 specifications are available, as well as custom colors. Also available is a selection of seven exterior anodized options.

**C** The frame perimeter consists of a high-quality foam-filled weatherstrip.

Inswing and outswing doors receive a factory-applied vinyl installation flange with drip cap. Some inswing patio doors require an adjustable metal installation flange. Optional aluminum flanges and metal installation clips are available.

#### SILL

##### Inswing Drainage Sill

**D** Premium grade aluminum inswing sill with an oak threshold. Sills have a built-in drainage channel that allows water to drain away from the interior of the door. A top plate is removable for easy channel cleaning. A polyurethane thermal barrier helps reduce heat loss. Available in clear anodized or dark bronze anodized finish.

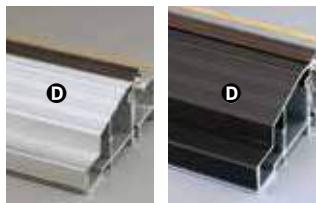

4 7/16" Inswing Drainage Sills

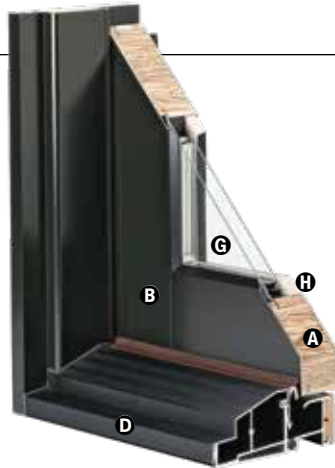

Inswing Patio Door with Contemporary Panel

##### Outswing On-Floor Sill

**E** Premium grade aluminum outswing sill with oak threshold. Outswing door sill is backed with a compression foam weatherstrip. Available in clear anodized or dark bronze anodized finish.

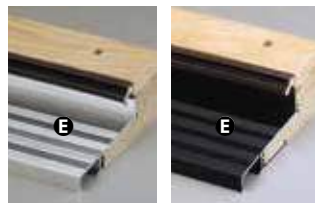

Outswing On-Floor Sills

##### Inswing & Outswing Low-Threshold Sills

**F** Aluminum low threshold sill available for outswing doors and inswing doors with jamb depths of 4 7/16" and 6 7/16". Low threshold design provides a smooth transition from interior to exterior and is wheelchair-accessible. A polyurethane thermal barrier helps reduce heat loss. Available in dark bronze anodized finish.

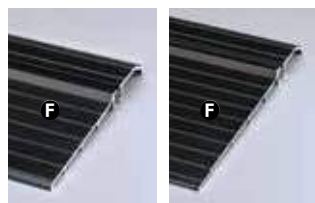

Inswing Low-Threshold Sills



Outswing Low-Threshold Sill

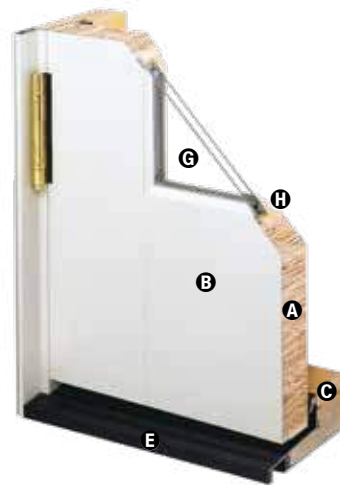

Outswing Patio Door with French Panel

#### GLASS

**G** High-Performance Low-E4® glass with a low-conductivity spacer. Triple-pane glass, tinted, clear dual-pane, high-altitude glass and other special glazing options are available.

**H** Glass is fixed in place from the interior with wood stops that can be removed for easy reglazing if necessary. Glass stops available in ovolo (colonial) and contemporary profiles.

#### HARDWARE

##### Multi-Point Locking System

Autolatch® stainless steel multi-point locking system locks the panel in three locations to provide a secure, weather-resistant entry system. Some door heights lock the panel in four locations.

##### Hinges



Heavy-duty commercial grade hinges are available in a standard finish of polished brass or optional finishes of limited lifetime brass, antique brass, oil rubbed bronze,\*\* pewter, satin chrome, bright chrome, white, black, stainless steel or gold dust to match your handle set. Hinges are complete with matching screws. An innovative hinge shimming system allows for minor adjustments.

\*Actual wood species is either Sapele or Sipo, both non-endangered species grown in Africa, with color and characteristics similar to Central American mahoganies.

\*\*Oil rubbed bronze is a "living" finish that will change with time and use.

**EXTERIOR & INTERIOR OPTIONS**

**EXTERIOR COLORS** 50 exterior colors, 7 anodized finishes and custom colors. See exterior colors on page 11.

**INTERIOR WOOD SPECIES**

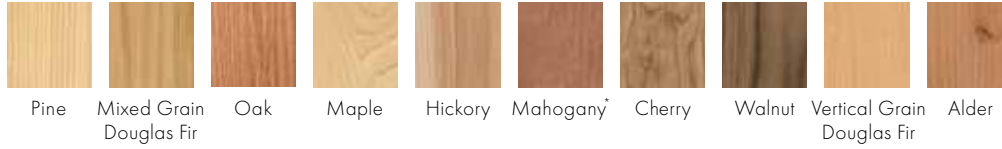

Naturally occurring variations in grain, color and texture of wood make each window one of a kind.

All factory-finished options are shown on pine.

Painted options available on pine. Dark bronze and black painted options available on pine or maple.

Anodized silver painted option available on maple only.

Interior custom stains, paints and color matching available.

**FACTORY-FINISHED INTERIORS**

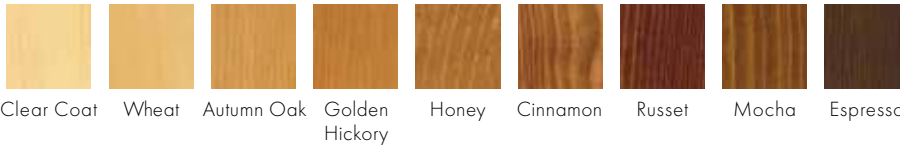

**INTERIOR PAINTED OPTIONS**



**HARDWARE OPTIONS**



Bold name denotes finish shown.

**HARDWARE FINISHES**



Oil rubbed bronze is a "living" finish that will change with time and use.

\*Actual wood species is either Sapele or Sipo, both non-endangered species grown in Africa, with color and characteristics similar to Central American mahoganies.

\*\*Matching hinges available in most hardware finishes for inswing patio doors.

Mix and match interior and exterior style and finish options are available, excludes FSB hardware.

Bright brass and satin nickel finishes feature a 10-year limited warranty.

Tribeca and Albany hardware are zinc diecast with powder-coated durable finish, other hardware is solid forged brass.

Printing limitations prevent exact replication of colors and finishes. See your Andersen supplier for actual color and finish samples.

"FSB" is a registered trademark of Franz Schneider Brakel GmbH & Co.

**FSB® HARDWARE**

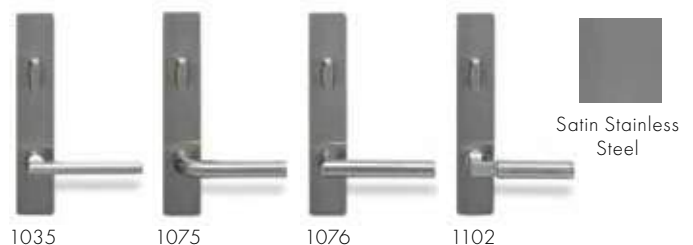

E-Series Hinged Patio Doors

# HINGED PATIO DOORS

## FEATURES

### HINGED PATIO DOORS

#### RAISED PANEL INSERTS



Available in 1/2 and 3/4 light options. Real wood, available in all wood species, makes up the interior panel insert. The exterior panel insert is made of formed aluminum cladding and is available in all 50 exterior colors and any custom color.

The raised panel inserts are based on the standard 8" bottom rail with 4 1/16" stiles. Available in nine widths to match standard door panel sizes.

Additional intermediate rail options available allowing glass lights to be placed above and below the intermediate rail.

#### TRANSOMS



Available in two jamb depths to align with your inswing door jamb depth. Design is sloped for water disbursement. Inswing and outswing sash-set transoms are available with 2 3/4", 3 1/16", 4 1/16" and 6 1/2" stiles to match your door.

#### SIDELIGHTS



Outswing venting sidelights have concealed locks and operate with our convenient folding operator handles. Interior wood-veneered insect screen can be customized to match your interior wood species and finish.

Inswing venting sidelights come with special hardware that locks in the center and complements the door's handle set. When the handle is activated upwards, shoot bolts engage at the head and sill for added security. Inswing venting sidelights feature an exterior insect screen.

Non-venting direct-set and sash-set sidelights are also available for both inswing and outswing patio doors.

#### CENTER POST DOOR



Allows door panels to be hinged at the center or at the jamb. Available in two jamb depths: 4 9/16" and 6 9/16".

The center post is clad laminated veneer lumber (LVL) that provides exceptional structural integrity. A top-hung gliding insect screen is available on the inswing center post door.

#### COMMERCIAL DOOR PANELS

Available in single or double door applications. The commercial door panels have a 12" bottom rail and 6 1/2" stiles. The commercial door panels have a 12" bottom rail, 6 1/2" stiles and an optional intermediate rail.

#### CONCEALED PANIC SYSTEM DOOR



We have created an innovative Concealed Panic System (CPS), eliminating the need for a center astragal and exposed vertical rods on double doors. This system provides a clear opening while maintaining a sleek, uncluttered interior look. The system locks at the head and sill for added security. You get the same warm, real wood interior you've come to expect from us without the unsightly clutter common to most commercial doors.

We've also aligned with Von Duprin®, the most recognized and trusted brand of commercial hardware in the window and door industry. Von Duprin, along with the Ingersoll-Rand family of brands, provides premium push bars, handle sets, closers and kick plates to make the CPS door truly innovative. Plus, our doors are factory-prepped, making installation much easier.



**ACCESSORIES** Sold Separately

**HINGED PATIO DOORS**

**HARDWARE**

**Construction Handle**



Temporary construction handle is available with all hinged patio doors. This handle allows operation during the construction phase, protecting finished hardware from damage or jobsite theft.

Additional hardware options such as exterior keyed locks and more are also available.

**SENSORS**

**Yale® Assure Lock®**

Monitor, lock and unlock from anywhere with the Yale Assure Lock. The sleek keyless lock includes Bluetooth® technology for key-free unlocking and is compatible with Z-Wave® for integration with a wide range of smart home platforms. See page 27 for Smart Home options.

**VeriLock® Security Sensors**

VeriLock sensors are unique as they detect whether the doors are locked or unlocked\* — a feature no other sensors can provide. See page 27 for Smart Home options.

**Open/Closed Sensors**

Wireless open/closed sensors are available in four colors. See page 27 for details.

**INSECT SCREENS**

**Retractable Insect Screens**



Concealed, retractable insect screen has charcoal fiberglass screen mesh. Available for inswing single or double door units. Insect screen rolls out when needed and retracts into concealed housing when not in use. Available in 50 exterior colors.

Retractable insect screens for outswing doors are field applied to the interior of the door. Available in five colors including white, almond, desert sand, bronze and black.

**Hinged Insect Screens for Inswing Patio Doors**

Charcoal fiberglass screen mesh fits into an aluminum frame in 50 exterior colors. Provided with a black lockable latch and automatic closer for smooth operation. Available in single or multiple door units. Aluminum screen mesh is also available.

**Top-Hung Gliding Insect Screens for Inswing Center Post Patio Doors**

Charcoal fiberglass screen mesh fits into an aluminum frame available in 50 exterior colors. Aluminum screen mesh is also available.

**PRIVACY OPTIONS**

**Blinds-Between-the-Glass**



A 5/8" aluminum slot blind mounted between two panes of insulated glass in a dust-free environment. Available in white, tan and almond. Blinds are magnetically controlled and can be tilted or raised and lowered with one cord.\*\* Not available on arch patio doors.

**GRILLES**

**Full Divided Light**

Permanent interior and exterior grilles with grille spacer bars between two panes of glass. Available in 5/8", 7/8", 1 1/8", 1 1/2", or 2 1/4" widths. Interior grilles are available with ovolo or contemporary profile (ovolo profile shown below). Not all widths are shown.



5/8"

7/8"

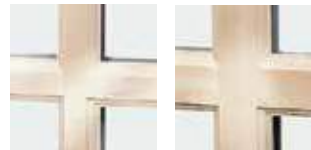

1 1/8"

1 1/2"

**Simulated Divided Light**

Permanent exterior and interior grilles without grille spacer bars. Available in 5/8", 7/8", 1 1/8", 1 1/2", or 2 1/4" widths. Interior grilles are available with ovolo or contemporary profile (ovolo profile shown below). Not all widths are shown.



7/8"

**Finelight™ Grilles-Between-the-Glass**

Available in 5/8" flat or 1" contoured aluminum profiles. Two-tone colors of pebble tan/colony white, sierra bronze/colony white or forest green/colony white are available on the 1" profile.



5/8" Flat

1" Contoured

**Removable Interior Wood Grilles**

Removable interior wood grilles are available in a 7/8" width and ovolo or contemporary profiles. Optional surround for removable grille and permanent exterior grilles also available.



7/8"

See page 22 for more information on grilles.

\*When properly configured and maintained with a professionally installed security system and/or self-monitoring system compatible with Honeywell® 5800 controls. See your Andersen supplier for more information.

\*\*Not all sizes are retractable. See your local Andersen supplier for details.

## Hinged Patio Door Panel Labeling

### Door Panel Options

Andersen® E-Series offers a wide range of door styles to accommodate any home project style. Both contemporary and French panel styles are available to complement traditional or modern architecture.

Hinged Patio Door Contemporary Panels

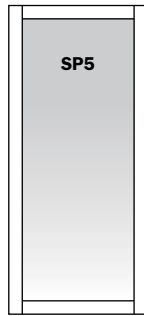

3<sup>1</sup>/<sub>16</sub>" stiles & rails

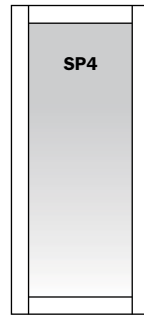

4<sup>1</sup>/<sub>16</sub>" stiles & rails

Hinged Patio Door French Panels

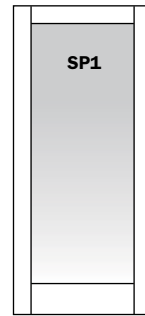

4<sup>1</sup>/<sub>16</sub>" stiles, 4<sup>1</sup>/<sub>16</sub>" top rail & 8" bottom rail

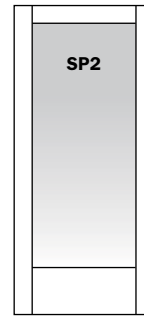

4<sup>1</sup>/<sub>16</sub>" stiles, 4<sup>1</sup>/<sub>16</sub>" top rail & 12" bottom rail

---

### Panels with 5<sup>5</sup>/<sub>16</sub>" Intermediate Rail 23<sup>1</sup>/<sub>4</sub>" from Bottom of Panel

---

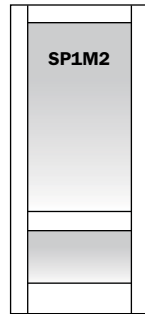

4<sup>1</sup>/<sub>16</sub>" stiles, 4<sup>1</sup>/<sub>16</sub>" top rail & 8" bottom rail

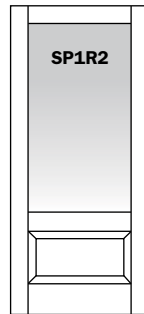

4<sup>1</sup>/<sub>16</sub>" stiles, 4<sup>1</sup>/<sub>16</sub>" top rail, 8" bottom rail & raised panel insert

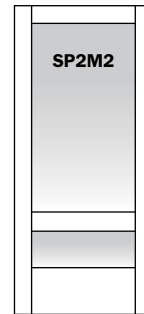

4<sup>1</sup>/<sub>16</sub>" stiles, 4<sup>1</sup>/<sub>16</sub>" top rail & 12" bottom rail

---

### Panels with 5<sup>5</sup>/<sub>16</sub>" Intermediate Rail 35" from Bottom of Panel

---

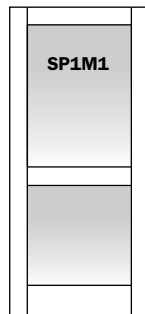

4<sup>1</sup>/<sub>16</sub>" stiles, 4<sup>1</sup>/<sub>16</sub>" top rail & 8" bottom rail

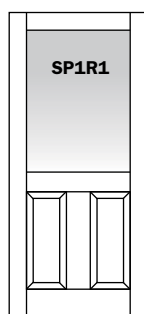

4<sup>1</sup>/<sub>16</sub>" stiles, 4<sup>1</sup>/<sub>16</sub>" top rail, 8" bottom rail & raised panel insert

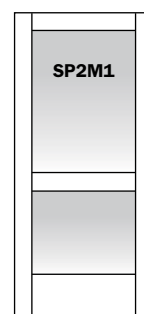

4<sup>1</sup>/<sub>16</sub>" stiles, 4<sup>1</sup>/<sub>16</sub>" top rail & 12" bottom rail

**Sidelight Panels**

Contemporary Panel

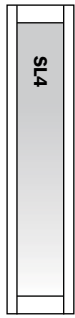

2 3/4" stiles  
4 1/16" top rail  
& bottom rail

French Panels

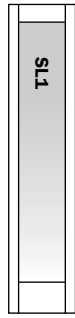

2 3/4" stiles  
4 1/16" top rail  
8" bottom rail

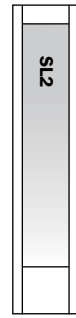

2 3/4" stiles  
4 1/16" top rail  
12" bottom rail

5 5/16" Intermediate Rail 23 3/4" from Bottom of Panel

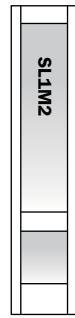

2 3/4" stiles  
4 1/16" top rail  
8" bottom rail

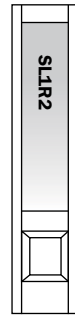

2 3/4" stiles  
4 1/16" top rail  
8" bottom rail &  
raised panel insert

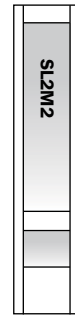

2 3/4" stiles  
4 1/16" top rail  
12" bottom rail

5 5/16" Intermediate Rail 35" from Bottom of Panel

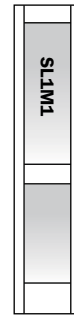

2 3/4" stiles  
4 1/16" top rail  
8" bottom rail

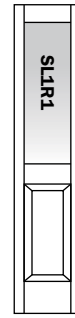

2 3/4" stiles  
4 1/16" top rail  
8" bottom rail &  
raised panel insert

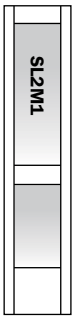

2 3/4" stiles  
4 1/16" top rail  
12" bottom rail

**Transom Panels**



2 3/4" stiles & rails



2 3/4" stiles & 4 1/16" rails

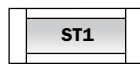

4 1/16" stiles & 2 3/4" rails

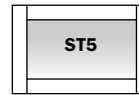

3 1/16" stiles & rails

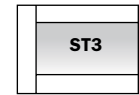

4 1/16" stiles & rails

**Commercial Door, Sidelight & Transom Panels\***

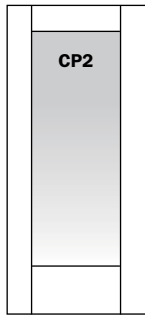

6 1/2" stiles, 6 1/2" top rail  
& 12" bottom rail

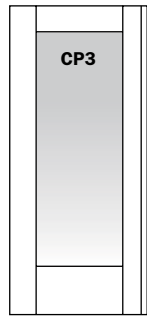

6 1/2" stiles, 6 1/2" top rail  
& 12" bottom rail  
Concealed Panic System

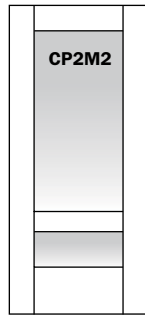

6 1/2" stiles, 6 1/2" top rail  
& 12" bottom rail with  
5 5/16" intermediate rail  
23 3/4" from bottom of panel

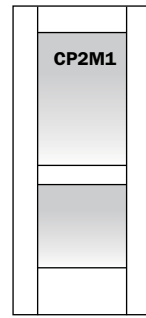

6 1/2" stiles, 6 1/2" top rail  
& 12" bottom rail with  
5 5/16" intermediate rail  
35" from bottom of panel

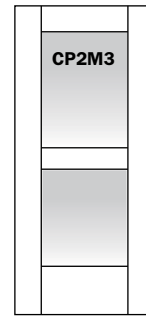

6 1/2" stiles, 6 1/2" top rail  
& 12" bottom rail with  
5 5/16" intermediate rail  
39" from bottom of panel

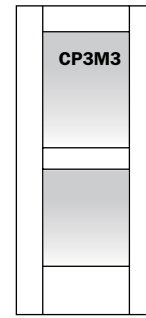

6 1/2" stiles, 6 1/2" top rail  
& 12" bottom rail with  
5 5/16" intermediate rail  
39" from bottom of panel  
Concealed Panic System

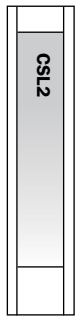

2 3/4" stiles,  
6 1/2" top rail &  
12" bottom rail

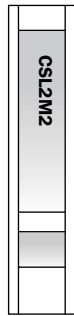

2 3/4" stiles, 6 1/2" top rail  
& 12" bottom rail with  
5 5/16" intermediate rail  
23 3/4" from bottom of panel

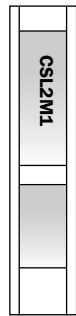

2 3/4" stiles, 6 1/2" top rail  
& 12" bottom rail with  
5 5/16" intermediate rail  
35" from bottom of panel

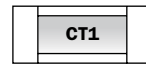

6 1/2" stiles & 2 3/4" rails

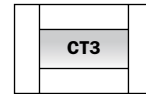

6 1/2" stiles & rails



2 3/4" stiles & 6 1/2" rails

\* Also available for residential applications.

## Arch Panels

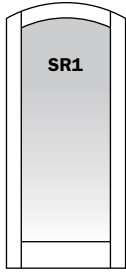

4 1/16" stiles, 4 1/16" top rail & 8" bottom rail

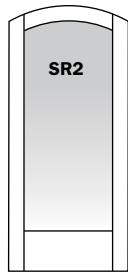

4 1/16" stiles, 4 1/16" top rail & 12" bottom rail

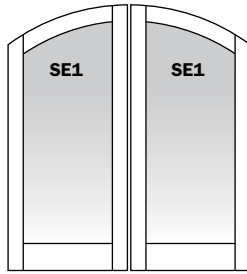

4 1/16" stiles, 4 1/16" top rail & 8" bottom rail

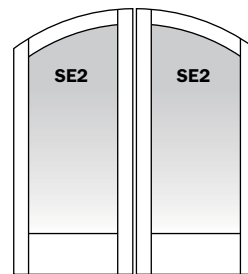

4 1/16" stiles, 4 1/16" top rail & 12" bottom rail

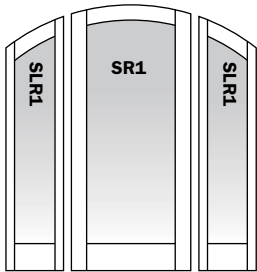

2 3/4" stiles 4 1/16" stiles  
4 1/16" top rail 4 1/16" top rail  
8" bottom rail 8" bottom rail

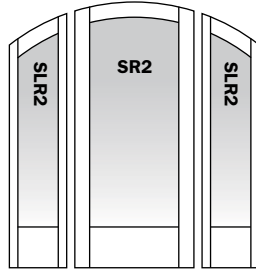

2 3/4" stiles 4 1/16" stiles  
4 1/16" top rail 4 1/16" top rail  
12" bottom rail 12" bottom rail

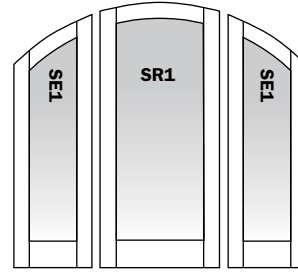

4 1/16" stiles 4 1/16" stiles  
4 1/16" top rail 4 1/16" top rail  
8" bottom rail 8" bottom rail

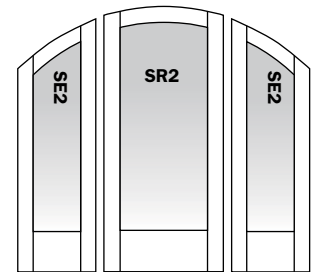

4 1/16" stiles 4 1/16" stiles  
4 1/16" top rail 4 1/16" top rail  
12" bottom rail 12" bottom rail

## Arch Panels with 5 1/16" Intermediate Rail 23 1/4" from Bottom of Panel

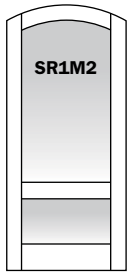

4 1/16" stiles, 4 1/16" top rail & 8" bottom rail

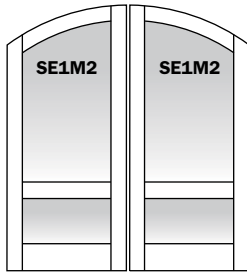

4 1/16" stiles, 4 1/16" top rail & 8" bottom rail

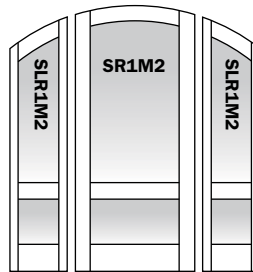

2 3/4" stiles 4 1/16" stiles  
4 1/16" top rail 4 1/16" top rail  
8" bottom rail 8" bottom rail

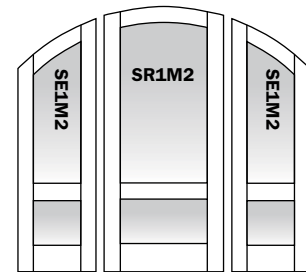

4 1/16" stiles 4 1/16" stiles  
4 1/16" top rail 4 1/16" top rail  
8" bottom rail 8" bottom rail

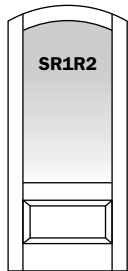

4 1/16" stiles, 4 1/16" top rail, 8" bottom rail & raised panel insert

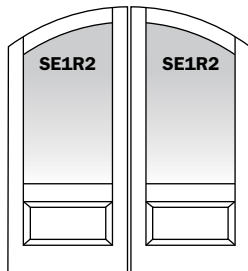

4 1/16" stiles, 4 1/16" top rail, 8" bottom rail & raised panel inserts

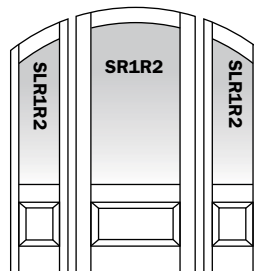

2 3/4" stiles, 4 1/16" stiles,  
4 1/16" top rail, 4 1/16" top rail,  
8" bottom rail & raised panel insert & raised panel insert

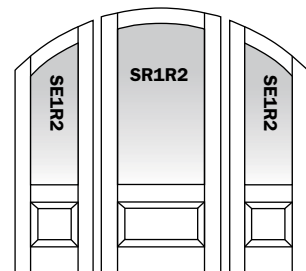

4 1/16" stiles, 4 1/16" stiles,  
4 1/16" top rail, 4 1/16" top rail,  
8" bottom rail & raised panel insert & raised panel insert

**Arch Panels with 5<sup>5</sup>/<sub>16</sub>" Intermediate Rail 23<sup>1</sup>/<sub>4</sub>" from Bottom of Panel (Continued)**

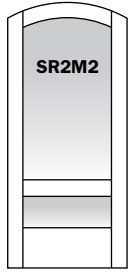

4<sup>1</sup>/<sub>16</sub>" stiles, 4<sup>1</sup>/<sub>16</sub>" top rail & 12" bottom rail

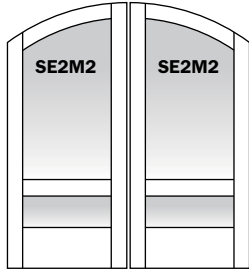

4<sup>1</sup>/<sub>16</sub>" stiles, 4<sup>1</sup>/<sub>16</sub>" top rail & 12" bottom rail

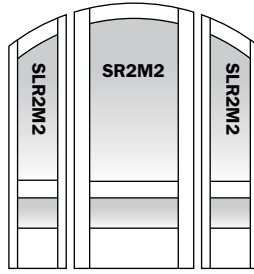

2<sup>3</sup>/<sub>4</sub>" stiles 4<sup>1</sup>/<sub>16</sub>" stiles  
4<sup>1</sup>/<sub>16</sub>" top rail 4<sup>1</sup>/<sub>16</sub>" top rail  
12" bottom rail 12" bottom rail

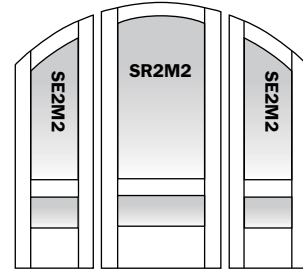

4<sup>1</sup>/<sub>16</sub>" stiles 4<sup>1</sup>/<sub>16</sub>" stiles  
4<sup>1</sup>/<sub>16</sub>" top rail 4<sup>1</sup>/<sub>16</sub>" top rail  
12" bottom rail 12" bottom rail

**Arch Panels with 5<sup>5</sup>/<sub>16</sub>" Intermediate Rail 35" from Bottom of Panel**

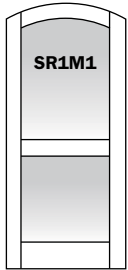

4<sup>1</sup>/<sub>16</sub>" stiles, 4<sup>1</sup>/<sub>16</sub>" top rail & 8" bottom rail

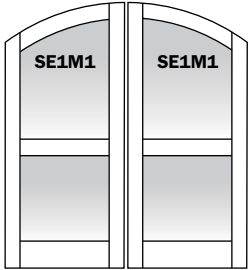

4<sup>1</sup>/<sub>16</sub>" stiles, 4<sup>1</sup>/<sub>16</sub>" top rail & 8" bottom rail

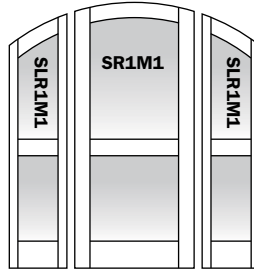

2<sup>3</sup>/<sub>4</sub>" stiles 4<sup>1</sup>/<sub>16</sub>" stiles  
4<sup>1</sup>/<sub>16</sub>" top rail 4<sup>1</sup>/<sub>16</sub>" top rail  
8" bottom rail 8" bottom rail

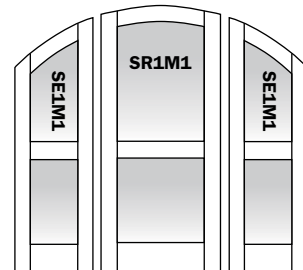

4<sup>1</sup>/<sub>16</sub>" stiles 4<sup>1</sup>/<sub>16</sub>" stiles  
4<sup>1</sup>/<sub>16</sub>" top rail 4<sup>1</sup>/<sub>16</sub>" top rail  
8" bottom rail 8" bottom rail

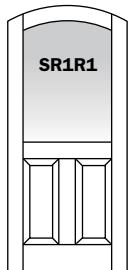

4<sup>1</sup>/<sub>16</sub>" stiles, 4<sup>1</sup>/<sub>16</sub>" top rail, 8" bottom rail & raised panel insert

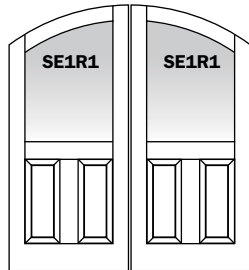

4<sup>1</sup>/<sub>16</sub>" stiles, 4<sup>1</sup>/<sub>16</sub>" top rail, 8" bottom rail & raised panel inserts

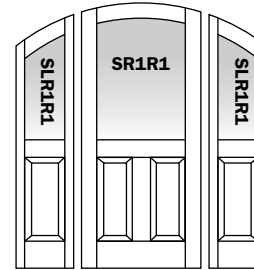

2<sup>3</sup>/<sub>4</sub>" stiles, 4<sup>1</sup>/<sub>16</sub>" stiles,  
4<sup>1</sup>/<sub>16</sub>" top rail, 4<sup>1</sup>/<sub>16</sub>" top rail,  
8" bottom rail 8" bottom rail  
& raised panel insert & raised panel insert

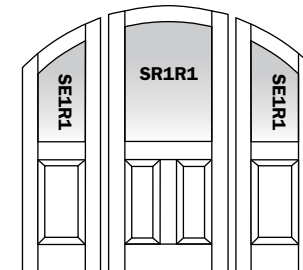

4<sup>1</sup>/<sub>16</sub>" stiles, 4<sup>1</sup>/<sub>16</sub>" stiles,  
4<sup>1</sup>/<sub>16</sub>" top rail, 4<sup>1</sup>/<sub>16</sub>" top rail,  
8" bottom rail 8" bottom rail  
& raised panel insert & raised panel insert

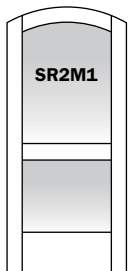

4<sup>1</sup>/<sub>16</sub>" stiles, 4<sup>1</sup>/<sub>16</sub>" top rail & 12" bottom rail

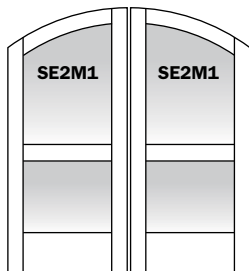

4<sup>1</sup>/<sub>16</sub>" stiles, 4<sup>1</sup>/<sub>16</sub>" top rail & 12" bottom rail

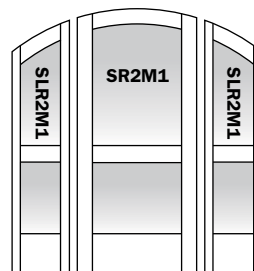

2<sup>3</sup>/<sub>4</sub>" stiles 4<sup>1</sup>/<sub>16</sub>" stiles  
4<sup>1</sup>/<sub>16</sub>" top rail 4<sup>1</sup>/<sub>16</sub>" top rail  
12" bottom rail 12" bottom rail

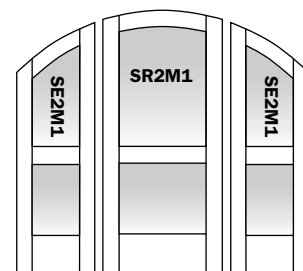

4<sup>1</sup>/<sub>16</sub>" stiles 4<sup>1</sup>/<sub>16</sub>" stiles  
4<sup>1</sup>/<sub>16</sub>" top rail 4<sup>1</sup>/<sub>16</sub>" top rail  
12" bottom rail 12" bottom rail

# HINGED PATIO DOORS

## Hinged Patio Door Handing

The door handing and order designation noted below and on the opposite page is consistent with the handing of other Andersen® doors and is used throughout the remainder of the hinged patio doors section.

### Identification

All hinged doors are **viewed from the exterior**. From left to right, choose stationary, active or passive, then choose hinge location.

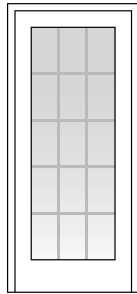

**Stationary Panel**  
Non-operating panel.

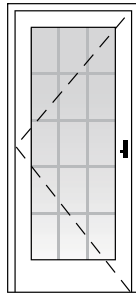

**Left Hinged**  
Hinges mounted on the left side of the panel.

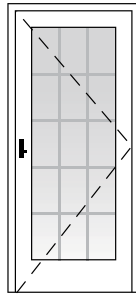

**Right Hinged**  
Hinges mounted on the right side of the panel.

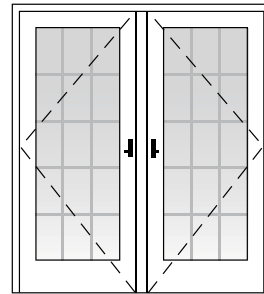

**Active Panel**   **Passive Panel**  
The operating panel most often used.   The operating panel with astragal attached.

## Hinged Patio Doors — Inswing

### Handing Options

#### Single Door

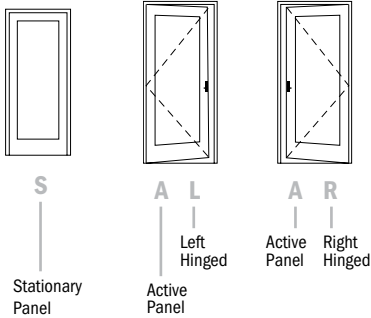

#### Double Door

(shown as APLR)

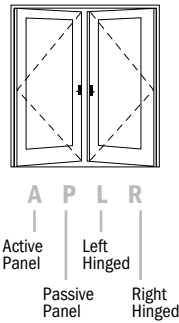

#### Center Post Door

(shown as hinged off astragal)

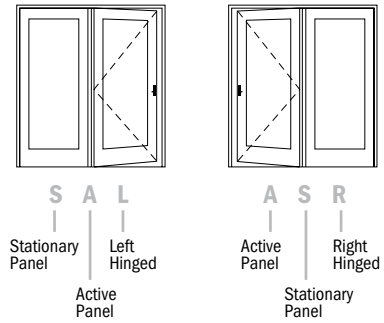

Order Designation Description	
	As Viewed From Exterior
Single Door	S
	AL
	AR
Double Door	PALR
	APLR
	SS
Center Post Door – Hinged Off Jamb	SAR
	ASL
Center Post Door – Hinged Off Astragal	SAL
	ASR

# Hinged Patio Doors — Outswing

## Handing Options

### Single Door

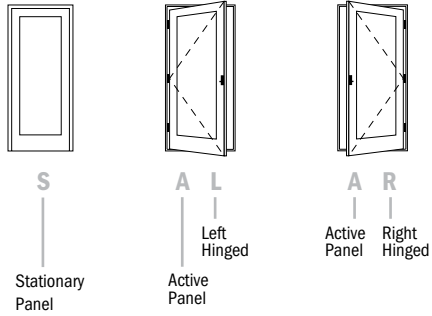

### Double Door

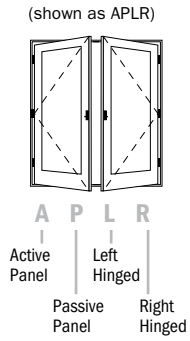

Order Designation Description	
	As Viewed From Exterior
Single Door	S
	AR
	AL
Double Door	APLR
	PALR
	SS

# HINGED PATIO DOORS

## Single Hinged Inswing Patio Door & Sidelight Sizes

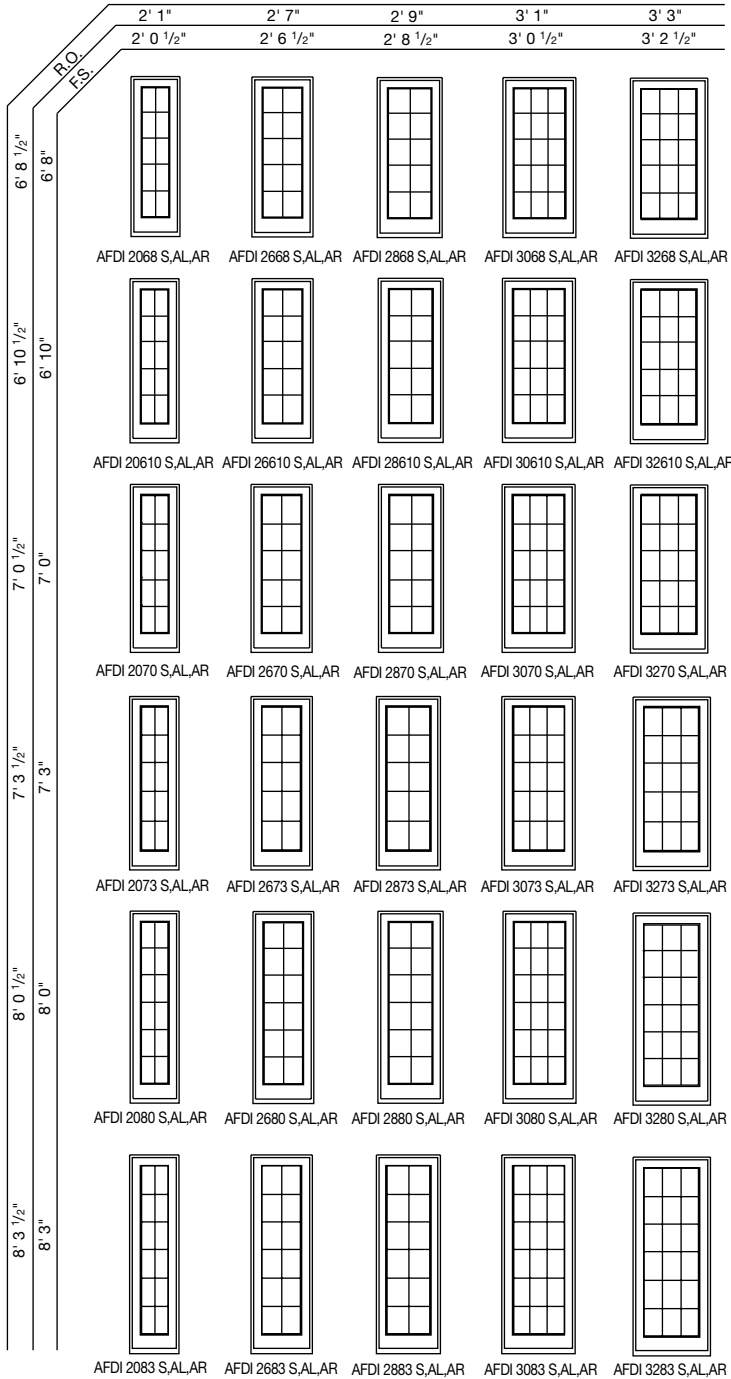

### NOTES

All doors and sidelights use safety/tempered glass.

The minimum vertical joining material width for doors and sidelights is 1/2".

See handing chart on page 132 for operation options.

Use structural joining material when necessary or required by code.

The light patterns illustrated apply to removable interior wood grilles, Full Divided Light, Simulated Divided Light, Decorelle 100, 150 and 400 and Finelight™ Grille-Between-the-Glass. All removable interior wood grilles will be installed in the units unless otherwise specified.

For a metric conversion in millimeters, multiply dimensions in inches by 25.4.

### Inswing Frame Height (using Low Threshold Sill)

= Standard Inswing Frame Height – 15/16"

### FORMULA FOR COMBINATION DOORS

The overall frame dimension (both width and height) is equal to the sum of the individual unit frame dimensions plus joining material dimension(s).

The overall rough opening (both width and height) is equal to the overall frame dimensions plus 1/4" on all sides.

Any unit within each combination can be operating or stationary except for direct-set units and transoms.



**Double Hinged Inswing Patio Door Sizes**

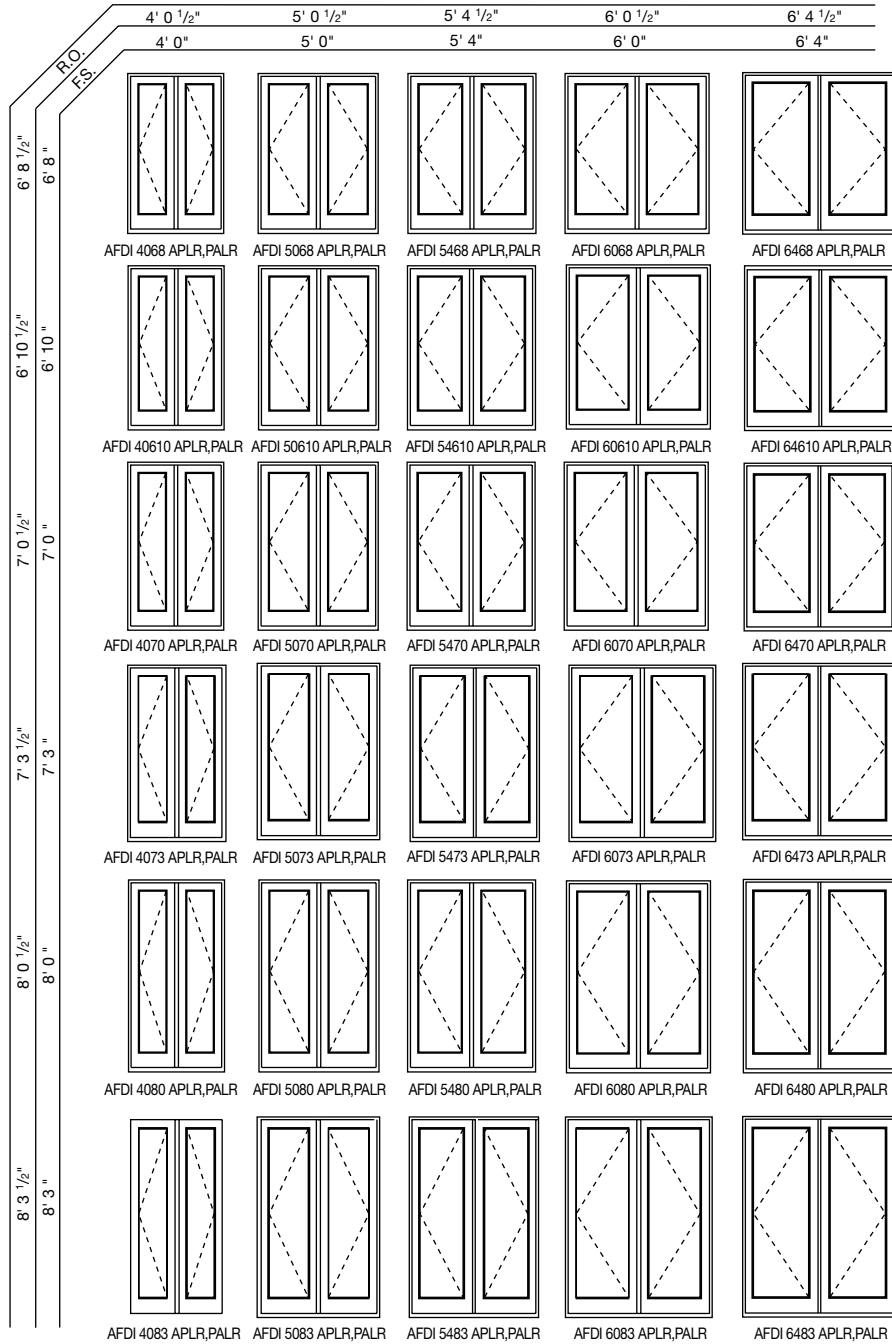

**NOTES**

All doors and sidelights use safety/tempered glass.

The minimum vertical joining material width for doors and sidelights is 1/2".

See handing chart on page 132 for operation options.

Use structural joining material when necessary or required by code.

For a metric conversion in millimeters, multiply dimensions in inches by 25.4.

**Inswing Frame Height  
(using Low Threshold Sill)**

= Standard Inswing Frame Height - 15/16"

**FORMULA FOR COMBINATION DOORS**

The overall frame dimension (both width and height) is equal to the sum of the individual unit frame dimensions plus joining material dimension(s).

The overall rough opening (both width and height) is equal to the overall frame dimensions plus 1/4" on all sides.

Any unit within each combination can be operating or stationary except for direct-set units and transoms.

**ALSO AVAILABLE AS:**

- Stationary Doors SS
- Center Post Doors SAR, ASL, SAL, ASR

# HINGED PATIO DOORS

## Inswing Sash-Set Sidelight Sizes

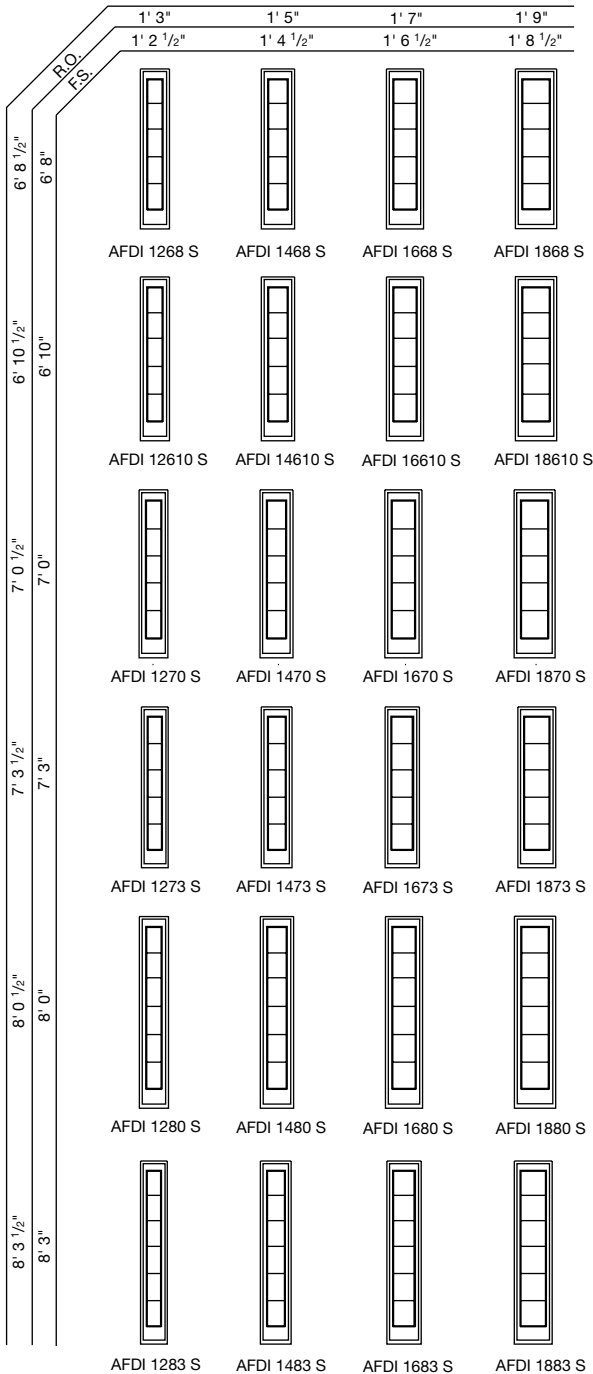

## Inswing Direct-Set Sidelight Sizes

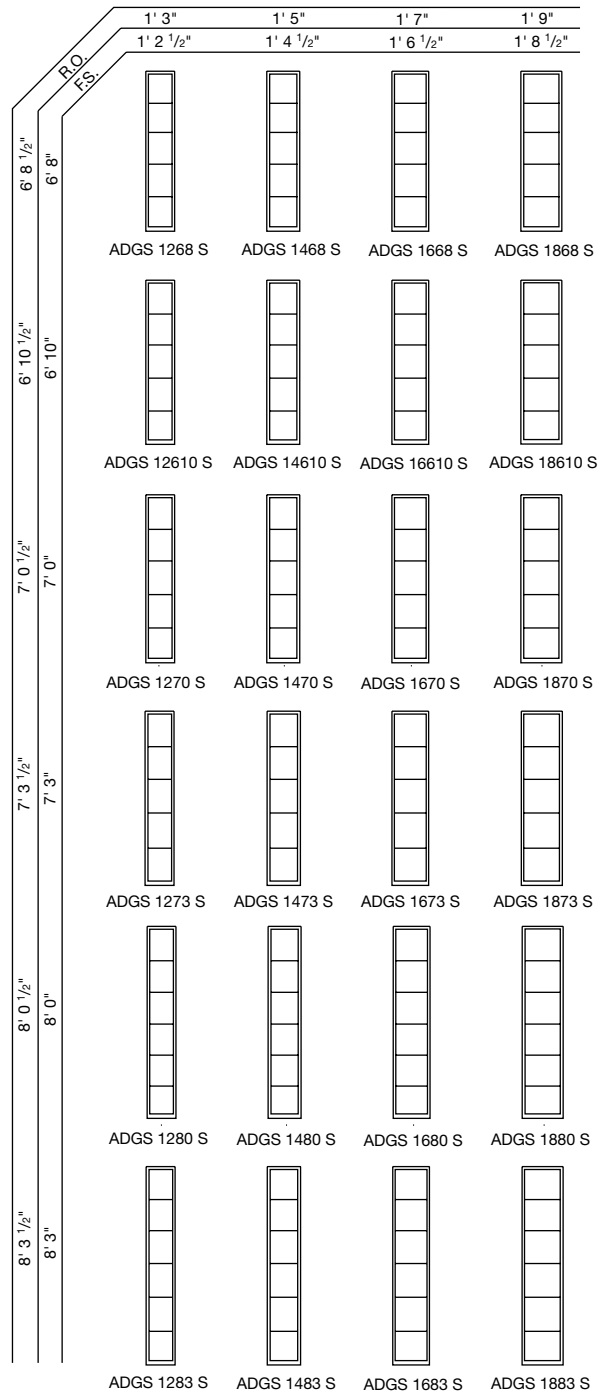

### NOTES

All doors and sidelights use safety/tempered glass.

The minimum vertical joining material width for doors and sidelights is 1/2". When joining a venting sidelight to a door, the minimum vertical joining material width is 2".

Use structural joining material when necessary or required by code.

The light patterns illustrated apply to removable interior wood grilles, Full Divided Light, Simulated Divided Light, Decorelle 100, 150 and 400 and Finelight™ Grilles-Between-the-Glass. All removable interior wood grilles will be installed in the units unless otherwise specified.

For a metric conversion in millimeters, multiply dimensions in inches by 25.4.

### Inswing Frame Height (using Low Threshold Sill)

= Standard Inswing Frame Height - 15/16"

### FORMULA FOR COMBINATION DOORS

The overall frame dimension (both width and height) is equal to the sum of the individual unit frame dimensions plus joining material dimension(s).

The overall rough opening (both width and height) is equal to the overall frame dimensions plus 1/4" on all sides.

Any unit within each combination can be operating or stationary except for direct-set units and transoms.

**FOR WINDOWS GREATER THAN 30 SQUARE FEET OR RATED HIGHER THAN PG50, ONE OF THESE THREE INSTALLATION METHODS IS REQUIRED:  
A) THROUGH THE JAMB B) ALUMINUM INSTALLATION FLANGE OR C) INSTALLATION CLIPS.  
ADDITIONAL CUSTOM SIZES ARE AVAILABLE. CONTACT YOUR LOCAL SUPPLIER FOR MORE INFORMATION. DRAWINGS ARE NOT TO SCALE.**

### Hinged Inswing Patio Door Sash-Set Transom Sizes

	2' 1"	2' 7"	2' 9"	3' 1"	3' 3"	4' 0 <sup>1</sup> / <sub>2</sub> "	5' 0 <sup>1</sup> / <sub>2</sub> "	5' 4 <sup>1</sup> / <sub>2</sub> "	6' 0 <sup>1</sup> / <sub>2</sub> "	6' 4 <sup>1</sup> / <sub>2</sub> "
	2' 0 <sup>1</sup> / <sub>2</sub> "	2' 6 <sup>1</sup> / <sub>2</sub> "	2' 8 <sup>1</sup> / <sub>2</sub> "	3' 0 <sup>1</sup> / <sub>2</sub> "	3' 2 <sup>1</sup> / <sub>2</sub> "	4' 0"	5' 0"	5' 4"	6' 0"	6' 4"
1' 2"										
1' 4"										
1' 6"										
1' 8"										
2' 0"										
2' 4"										
2' 6"										
2' 8"										
3' 0"										

### Hinged Inswing Patio Door Sash-Set Transom Sizes

	1' 3"	1' 5"	1' 7"	1' 9"
	1' 2 <sup>1</sup> / <sub>2</sub> "	1' 4 <sup>1</sup> / <sub>2</sub> "	1' 6 <sup>1</sup> / <sub>2</sub> "	1' 8 <sup>1</sup> / <sub>2</sub> "
1' 2"				
1' 4"				
1' 6"				
1' 8"				
2' 0"				

	1' 3"	1' 5"	1' 7"	1' 9"
	1' 2 <sup>1</sup> / <sub>2</sub> "	1' 4 <sup>1</sup> / <sub>2</sub> "	1' 6 <sup>1</sup> / <sub>2</sub> "	1' 8 <sup>1</sup> / <sub>2</sub> "
2' 4"				
2' 6"				
2' 8"				
3' 0"				

**NOTES**

If glass is positioned within 18" of the finished floor, safety/tempered glass may be required. Local codes may differ. Verify tempered glass requirements with your local building code official.

Use structural joining material when necessary or required by code.

The light patterns illustrated apply to removable interior wood grilles, Full Divided Light, Simulated Divided Light, Decorelle 100, 150 and 400 and Finelight™ Grilles-Between-the-Glass. All removable interior wood grilles will be installed in the units unless otherwise specified. The staggered light patterns illustrated align with light patterns in double doors. Other light patterns are available upon request.

For a metric conversion in millimeters, multiply dimensions in inches by 25.4.

**FORMULA FOR COMBINATION DOORS**

The overall frame dimension (both width and height) is equal to the sum of the individual unit frame dimensions plus joining material dimension(s).

The overall rough opening (both width and height) is equal to the overall frame dimensions plus 1/4" on all sides.

Any unit within each combination can be operating or stationary except for direct-set units and transoms.

**FOR WINDOWS GREATER THAN 30 SQUARE FEET OR RATED HIGHER THAN PG50, ONE OF THESE THREE INSTALLATION METHODS IS REQUIRED:  
A) THROUGH THE JAMB B) ALUMINUM INSTALLATION FLANGE OR C) INSTALLATION CLIPS.  
ADDITIONAL CUSTOM SIZES ARE AVAILABLE. CONTACT YOUR LOCAL SUPPLIER FOR MORE INFORMATION. DRAWINGS ARE NOT TO SCALE.**

# HINGED PATIO DOORS

## Hinged Inswing Patio Door Direct-Set Transom Sizes (Specialty Frame)

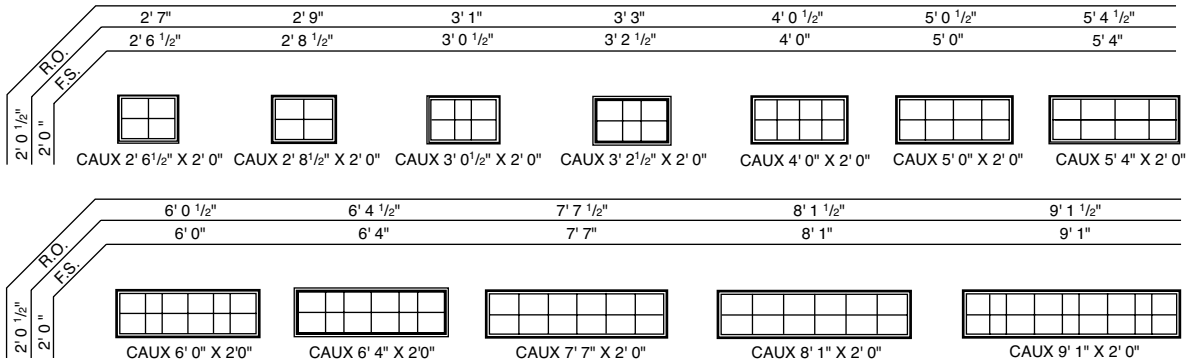

## Hinged Inswing Patio Door Direct-Set Elliptical Sizes (Specialty Frame)

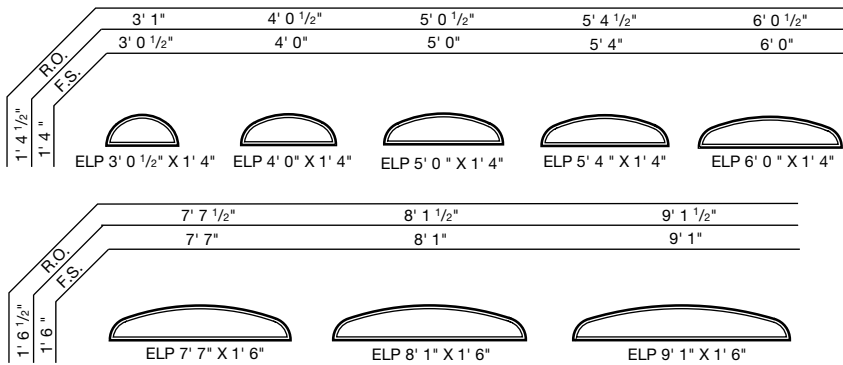

### NOTES

If glass is positioned within 18" of the finished floor, safety/tempered glass may be required. Local codes may differ. Verify tempered glass requirements with your local building code official.

- 2' 6-1/2" wide transoms are used above 2668, 26610 or 2680 Hinged Inswing Patio Doors.
- 2' 8-1/2" wide transoms are used above 2868, 28610 or 2880 Hinged Inswing Patio Doors.
- 3' 0-1/2" wide transoms are used above 3068, 30610 or 3080 Hinged Inswing Patio Doors.
- 4' 0" wide transoms are used above 4068, 40610 or 4080 Hinged Inswing Patio Doors.
- 5' 0" wide transoms are used above 5068, 50610 or 5080 Hinged Inswing Patio Doors.
- 5' 4" wide transoms are used above 5468, 54610 or 5480 Hinged Inswing Patio Doors.
- 6' 0" wide transoms are used above 6068, 60610 or 6080 Hinged Inswing Patio Doors.
- 7' 7" wide transoms are used above 5068/50610/5080 Hinged Inswing Patio Doors with 2668/26610/2680 Sidelights.
- 8' 1" wide transoms are used above 5468/54610/5480 Hinged Inswing Patio Doors with 2868/28610/2880 Sidelights.
- 9' 1" wide transoms are used above 6068/60610/6080 Hinged Inswing Patio Doors with 3068/30610/3080 Sidelights.

Use structural joining material when necessary or required by code.

The light patterns illustrated apply to removable interior wood grilles, Full Divided Light, Simulated Divided Light, Decorelle 100, 150 and 400 and Finelight™ Grilles-Between-the-Glass. All removable interior wood grilles will be installed in the units unless otherwise specified. The staggered light patterns illustrated align with light patterns in double doors. Other light patterns are available upon request.

For a metric conversion in millimeters, multiply dimensions in inches by 25.4.

### FORMULA FOR COMBINATION DOORS

The overall frame dimension (both width and height) is equal to the sum of the individual unit frame dimensions plus joining material dimension(s).

The overall rough opening (both width and height) is equal to the overall frame dimensions plus 1/4" on all sides.

Any unit within each combination can be operating or stationary except for direct-set units and transoms.

**FOR WINDOWS GREATER THAN 30 SQUARE FEET OR RATED HIGHER THAN PG50, ONE OF THESE THREE INSTALLATION METHODS IS REQUIRED:  
A) THROUGH THE JAMB B) ALUMINUM INSTALLATION FLANGE OR C) INSTALLATION CLIPS.  
ADDITIONAL CUSTOM SIZES ARE AVAILABLE. CONTACT YOUR LOCAL SUPPLIER FOR MORE INFORMATION. DRAWINGS ARE NOT TO SCALE.**

**Hinged Inswing Patio Door Direct-Set Half Circle Sizes (Specialty Frame)**

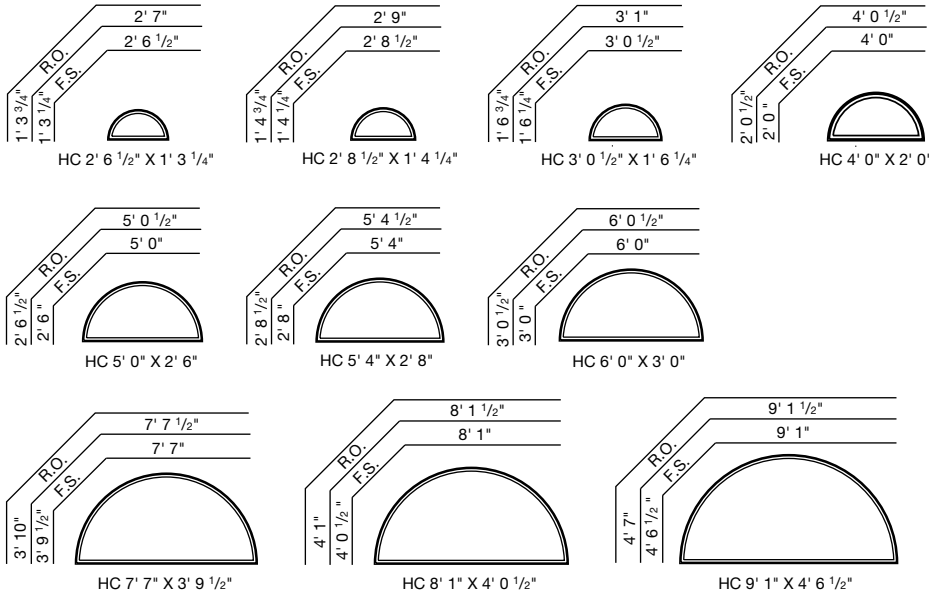

**Hinged Inswing Patio Door Direct-Set Transom Sizes**

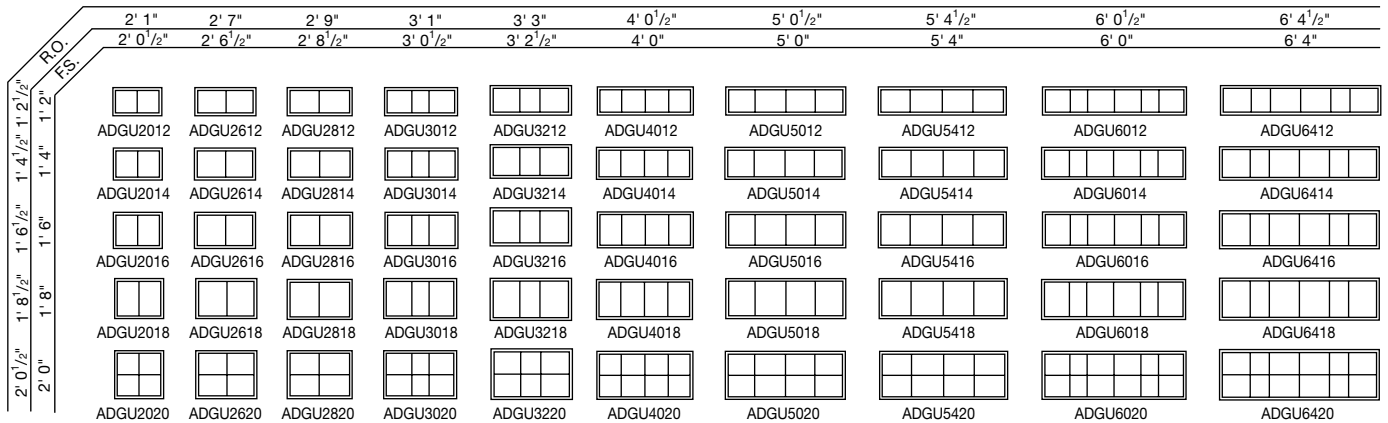

**NOTES**

If glass is positioned within 18" of the finished floor, safety/tempered glass may be required. Local codes may differ. Verify tempered glass requirements with your local building code official.

- 2' 6-1/2" wide transoms are used above 2668, 26610 or 2680 Hinged Inswing Patio Doors.
- 2' 8-1/2" wide transoms are used above 2868, 28610 or 2880 Hinged Inswing Patio Doors.
- 3' 0-1/2" wide transoms are used above 3068, 30610 or 3080 Hinged Inswing Patio Doors.
- 4' 0" wide transoms are used above 4068, 40610 or 4080 Hinged Inswing Patio Doors.
- 5' 0" wide transoms are used above 5068, 50610 or 5080 Hinged Inswing Patio Doors.
- 5' 4" wide transoms are used above 5468, 54610 or 5480 Hinged Inswing Patio Doors.
- 6' 0" wide transoms are used above 6068, 60610 or 6080 Hinged Inswing Patio Doors.
- 7' 7" wide transoms are used above 5068/50610/5080 Hinged Inswing Patio Doors with 2668/26610/2680 Sidelights.
- 8' 1" wide transoms are used above 5468/54610/5480 Hinged Inswing Patio Doors with 2868/28610/2880 Sidelights.
- 9' 1" wide transoms are used above 6068/60610/6080 Hinged Inswing Patio Doors with 3068/30610/3080 Sidelights.

Use structural joining material when necessary or required by code.

The light patterns illustrated apply to removable interior wood grilles, Full Divided Light, Simulated Divided Light, Decorelle 100, 150 and 400 and Finelight™ Grilles-Between-the-Glass. All removable interior wood grilles will be installed in the units unless otherwise specified. The staggered light patterns illustrated align with light patterns in double doors. Other light patterns are available upon request.

For a metric conversion in millimeters, multiply dimensions in inches by 25.4.

**FORMULA FOR COMBINATION DOORS**

The overall frame dimension (both width and height) is equal to the sum of the individual unit frame dimensions plus joining material dimension(s).

The overall rough opening (both width and height) is equal to the overall frame dimensions plus 1/4" on all sides.

Any unit within each combination can be operating or stationary except for direct-set units and transoms.

**FOR WINDOWS GREATER THAN 30 SQUARE FEET OR RATED HIGHER THAN PG50, ONE OF THESE THREE INSTALLATION METHODS IS REQUIRED:  
A) THROUGH THE JAMB B) ALUMINUM INSTALLATION FLANGE OR C) INSTALLATION CLIPS.  
ADDITIONAL CUSTOM SIZES ARE AVAILABLE. CONTACT YOUR LOCAL SUPPLIER FOR MORE INFORMATION. DRAWINGS ARE NOT TO SCALE.**

# HINGED PATIO DOORS

## Hinged Inswing Patio Door Direct-Set Transom Sizes

		2' 1"	2' 7"	2' 9"	3' 1"	3' 3"	4' 0 <sup>1</sup> / <sub>2</sub> "	5' 0 <sup>1</sup> / <sub>2</sub> "	5' 4 <sup>1</sup> / <sub>2</sub> "	6' 0 <sup>1</sup> / <sub>2</sub> "	6' 4 <sup>1</sup> / <sub>2</sub> "
		2' 0 <sup>1</sup> / <sub>2</sub> "	2' 6 <sup>1</sup> / <sub>2</sub> "	2' 8 <sup>1</sup> / <sub>2</sub> "	3' 0 <sup>1</sup> / <sub>2</sub> "	3' 2 <sup>1</sup> / <sub>2</sub> "	4' 0"	5' 0"	5' 4"	6' 0"	6' 4"
R.O. F.S.	2' 4 <sup>1</sup> / <sub>2</sub> "										
	2' 4"	ADGU2024	ADGU2624	ADGU2824	ADGU3024	ADGU3224	ADGU4024	ADGU5024	ADGU5424	ADGU6024	ADGU6424
	2' 6 <sup>1</sup> / <sub>2</sub> "										
	2' 6"	ADGU2026	ADGU2626	ADGU2826	ADGU3026	ADGU3226	ADGU4026	ADGU5026	ADGU5426	ADGU6026	ADGU6426
2' 8 <sup>1</sup> / <sub>2</sub> "											
2' 8"	ADGU2028	ADGU2628	ADGU2828	ADGU3028	ADGU3228	ADGU4028	ADGU5028	ADGU5428	ADGU6028	ADGU6428	
3' 0 <sup>1</sup> / <sub>2</sub> "											
3' 0"	ADGU2030	ADGU2630	ADGU2830	ADGU3030	ADGU3230	ADGU4030	ADGU5030	ADGU5430	ADGU6030	ADGU6430	

## Hinged Inswing Patio Door Direct-Set Transom Sizes

		1' 3"	1' 5"	1' 7"	1' 9"
		1' 2 <sup>1</sup> / <sub>2</sub> "	1' 4 <sup>1</sup> / <sub>2</sub> "	1' 6 <sup>1</sup> / <sub>2</sub> "	1' 8 <sup>1</sup> / <sub>2</sub> "
R.O. F.S.	1' 2 <sup>1</sup> / <sub>2</sub> "				
	1' 2"	ADGU1212	ADGU1412	ADGU1612	ADGU1812
	1' 4 <sup>1</sup> / <sub>2</sub> "				
	1' 4"	ADGU1214	ADGU1414	ADGU1614	ADGU1814
	1' 6 <sup>1</sup> / <sub>2</sub> "				
	1' 6"	ADGU1216	ADGU1416	ADGU1616	ADGU1816
	1' 8 <sup>1</sup> / <sub>2</sub> "				
	1' 8"	ADGU1218	ADGU1418	ADGU1618	ADGU1818
	2' 0 <sup>1</sup> / <sub>2</sub> "				
	2' 0"	ADGU1220	ADGU1420	ADGU1620	ADGU1820
2' 4 <sup>1</sup> / <sub>2</sub> "					
2' 4"	ADGU1224	ADGU1424	ADGU1624	ADGU1824	
2' 6 <sup>1</sup> / <sub>2</sub> "					
2' 6"	ADGU1226	ADGU1426	ADGU1626	ADGU1826	
2' 8 <sup>1</sup> / <sub>2</sub> "					
2' 8"	ADGU1228	ADGU1428	ADGU1628	ADGU1828	
3' 0 <sup>1</sup> / <sub>2</sub> "					
3' 0"	ADGU1230	ADGU1430	ADGU1630	ADGU1830	

### NOTES

If glass is positioned within 18" of the finished floor, safety/tempered glass may be required. Local codes may differ. Verify tempered glass requirements with your local building code official.

Use structural joining material when necessary or required by code.

The light patterns illustrated apply to removable interior wood grilles, Full Divided Light, Simulated Divided Light, Decorelle 100, 150 and 400 and Finelight™ Grilles-Between-the-Glass. All removable interior wood grilles will be installed in the units unless otherwise specified. The staggered light patterns illustrated align with light patterns in double doors. Other light patterns are available upon request.

For a metric conversion in millimeters, multiply dimensions in inches by 25.4.

### FORMULA FOR COMBINATION DOORS

The overall frame dimension (both width and height) is equal to the sum of the individual unit frame dimensions plus joining material dimension(s).

The overall rough opening (both width and height) is equal to the overall frame dimensions plus 1/4" on all sides.

Any unit within each combination can be operating or stationary except for direct-set units and transoms.

FOR WINDOWS GREATER THAN 30 SQUARE FEET OR RATED HIGHER THAN PG50, ONE OF THESE THREE INSTALLATION METHODS IS REQUIRED:  
 A) THROUGH THE JAMB B) ALUMINUM INSTALLATION FLANGE OR C) INSTALLATION CLIPS.  
 ADDITIONAL CUSTOM SIZES ARE AVAILABLE. CONTACT YOUR LOCAL SUPPLIER FOR MORE INFORMATION. DRAWINGS ARE NOT TO SCALE.

### Single Arch Inswing Patio Door & Sidelight Sizes

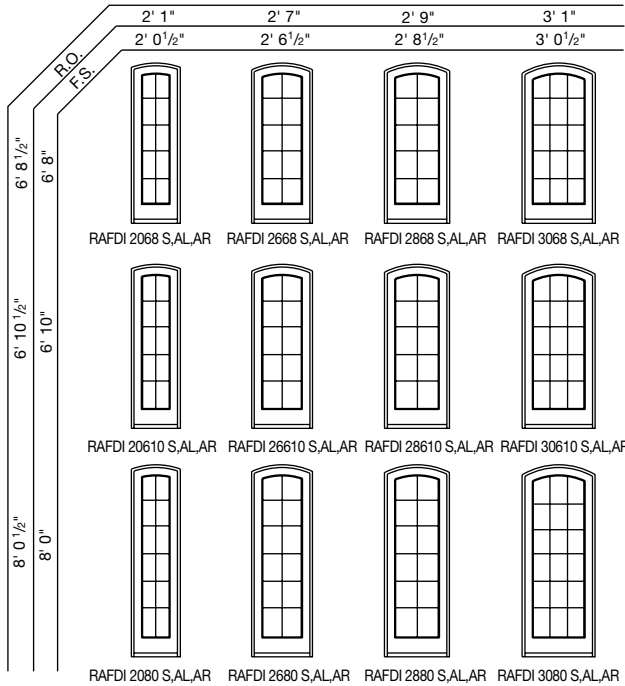

**NOTES**

All doors and sidelights use safety/tempered glass.

Single doors have a 3' 0" radius.

Double doors have a 5' 0" radius.

See handing chart on page 132 for operation options.

Use structural joining material when necessary or required by code.

The light patterns illustrated apply to removable interior wood grilles, Full Divided Light, Simulated Divided Light, Decorelle 100, 150 and 400 and Finelight™ Grilles-Between-the-Glass. All removable wood grilles will be installed in the units unless otherwise specified.

For a metric conversion in millimeters, multiply dimensions in inches by 25.4.

**Inswing Frame Height**  
(using Low Threshold Sill)  
= Standard Inswing Frame Height – 15/16"

**FORMULA FOR COMBINATION DOORS**

The overall frame dimension (both width and height) is equal to the sum of the individual unit frame dimensions plus joining material dimension(s).

The overall rough opening (both width and height) is equal to the overall frame dimensions plus 1/4" on all sides.

Any unit within each combination can be operating or stationary except for direct-set units and transoms.

### Double Arch Inswing Patio Door Sizes

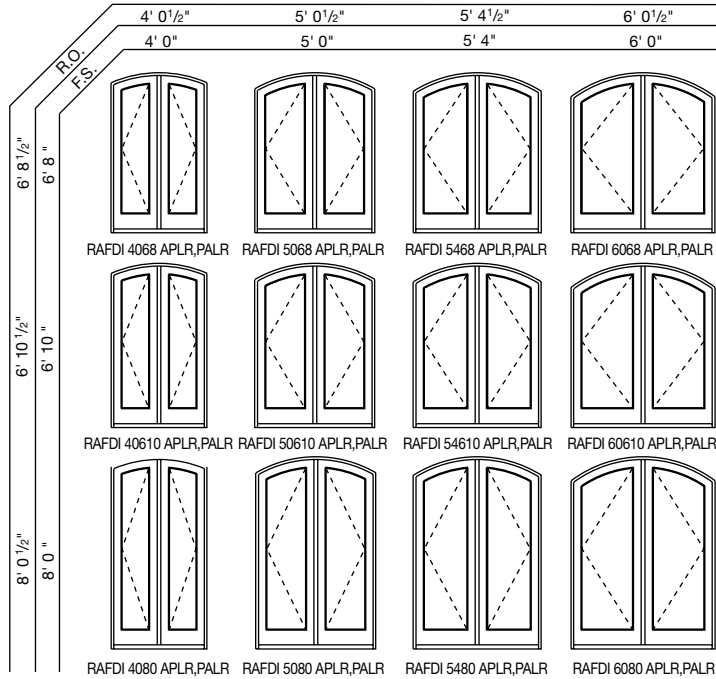

# HINGED PATIO DOORS

## 3-Wide Arch Inswing Patio Door & Sidelight Sizes

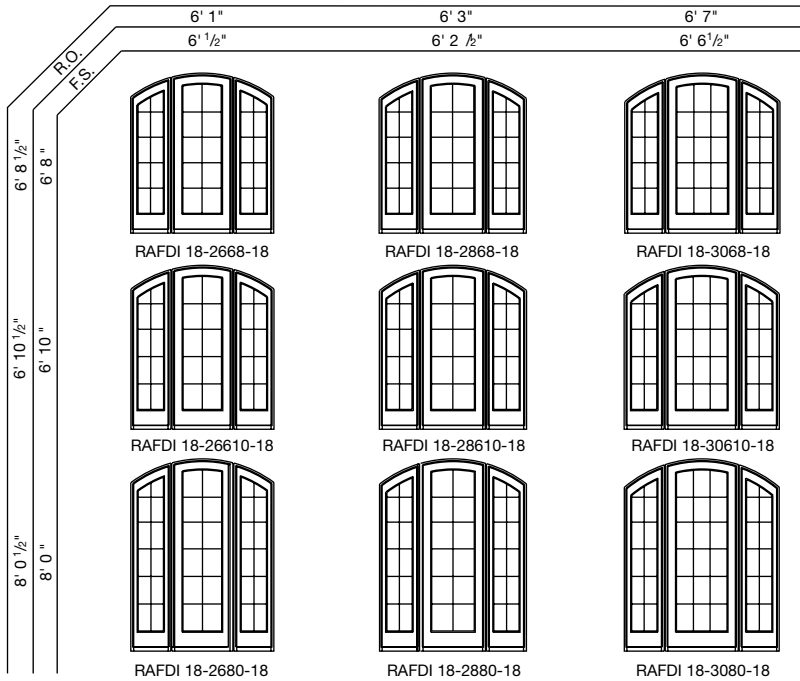

### NOTES

All doors and sidelights use safety/tempered glass.

3-wide doors have a 5' 0" radius.

See handing chart on page 132 for operation options.

Use structural joining material when necessary or required by code.

The light patterns illustrated apply to removable interior wood grilles, Full Divided Light, Simulated Divided Light, Decorelle 100, 150 and 400 and Finelight™ Grilles-Between-the-Glass. All removable interior wood grilles will be installed in the units unless otherwise specified.

For a metric conversion in millimeters, multiply dimensions in inches by 25.4.

### Inswing Frame Height Formula (using Low Threshold Sill)

= Standard Inswing Frame Height – 15/16"

### FORMULA FOR COMBINATION DOORS

The overall frame dimension (both width and height) is equal to the sum of the individual unit frame dimensions plus joining material dimension(s).

The overall rough opening (both width and height) is equal to the overall frame dimensions plus 1/4" on all sides.

Any unit within each combination can be operating or stationary except for arch sidelights.



**Hinged Inswing Patio Doors (4 9/16" Jamb Depth)**

**Hinged Inswing Patio Door**

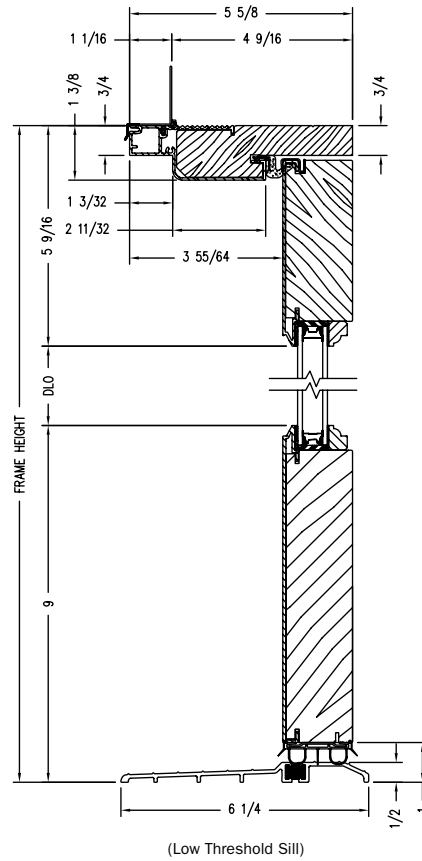
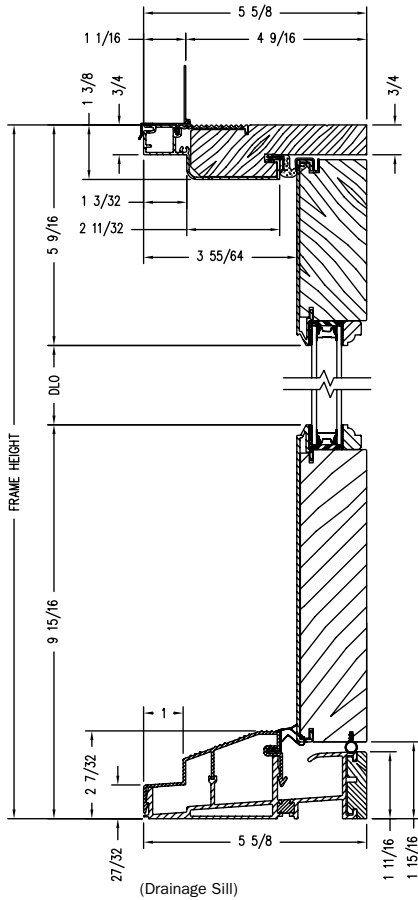

Vertical Section

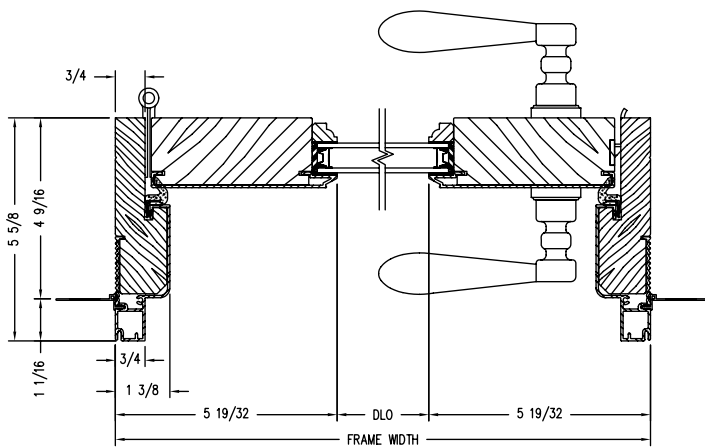

Horizontal Section

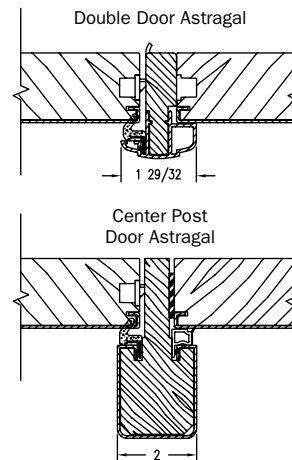

Astragal

Shown with ovolo (colonial) glass stops.  
French panel shown, also available with a contemporary panel.

**PROPER INSTALLATION AND MAINTENANCE OF E-SERIES PRODUCTS IS ESSENTIAL TO ATTAIN OPTIMUM PERFORMANCE AND OPERATION. WRITTEN INSTALLATION INSTRUCTIONS THAT PROVIDE GUIDELINES FOR PROPER INSTALLATION ARE AVAILABLE BY VISITING ANDERSENWINDOWS.COM. CUSTOM SIZES ARE AVAILABLE. CONTACT YOUR LOCAL SUPPLIER FOR MORE INFORMATION. DRAWINGS ARE NOT TO SCALE.**

# HINGED PATIO DOORS

## Hinged Inswing Patio Doors (4 9/16" Jamb Depth)

### Inswing Sash-Set Sidelight

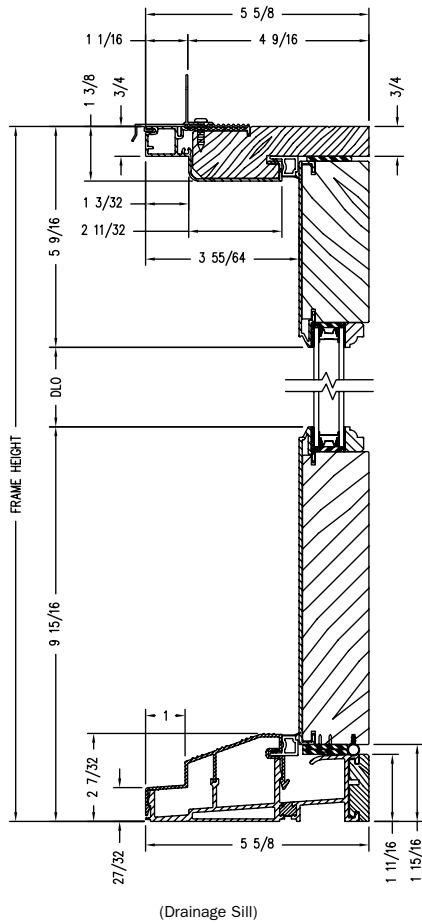

(Drainage Sill)

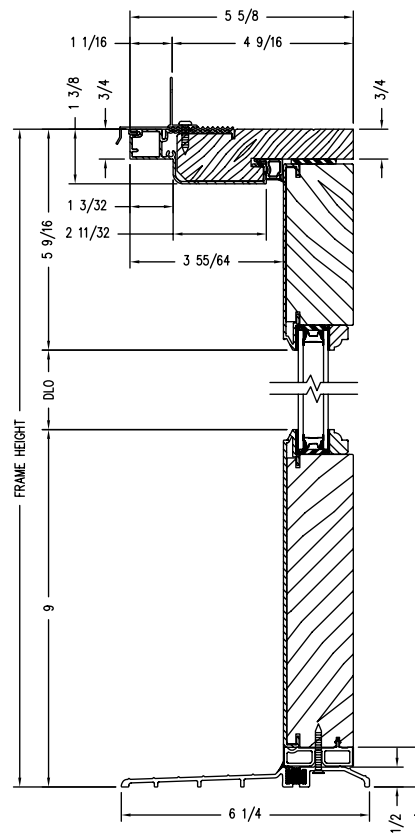

(Low Threshold Sill)

Vertical Section

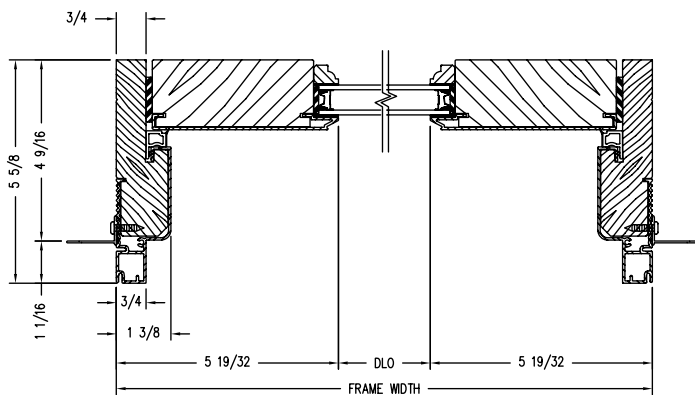

Horizontal Section

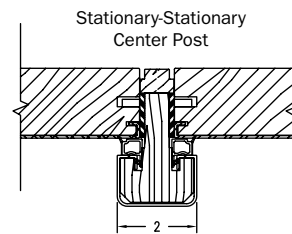

Astragal

Shown with ovolo (colonial) glass stops.

PROPER INSTALLATION AND MAINTENANCE OF E-SERIES PRODUCTS IS ESSENTIAL TO ATTAIN OPTIMUM PERFORMANCE AND OPERATION. WRITTEN INSTALLATION INSTRUCTIONS THAT PROVIDE GUIDELINES FOR PROPER INSTALLATION ARE AVAILABLE BY VISITING [ANDERSENWINDOWS.COM](http://ANDERSENWINDOWS.COM). CUSTOM SIZES ARE AVAILABLE. CONTACT YOUR LOCAL SUPPLIER FOR MORE INFORMATION. DRAWINGS ARE NOT TO SCALE.

**Hinged Inswing Patio Doors (4 9/16" Jamb Depth)**

**Inswing Direct-Set Sidelight**

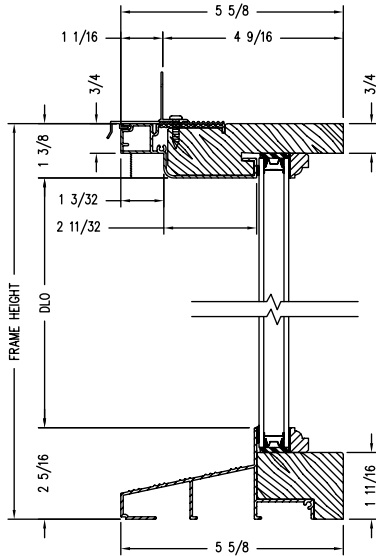

Vertical Section

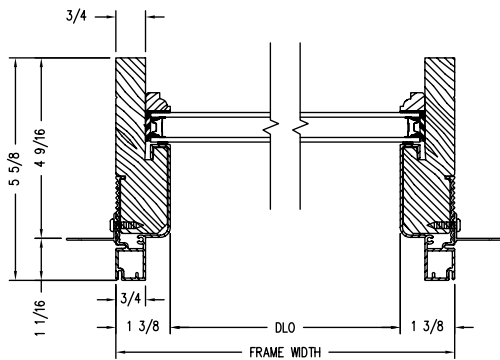

Horizontal Section

**Inswing Venting Sidelight**

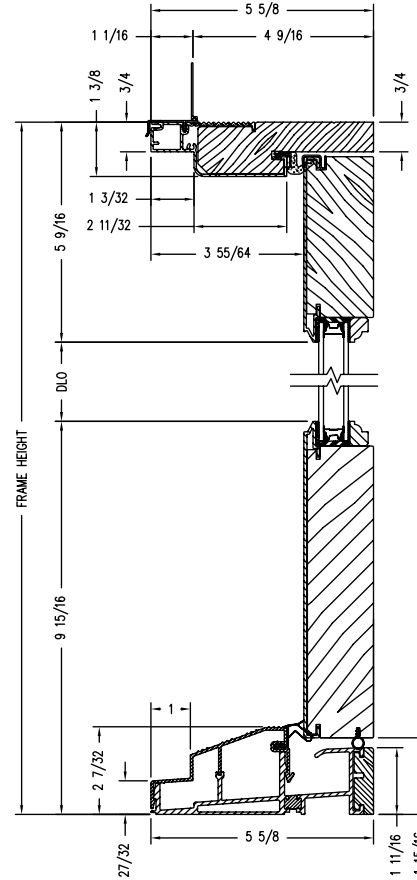

Vertical Section

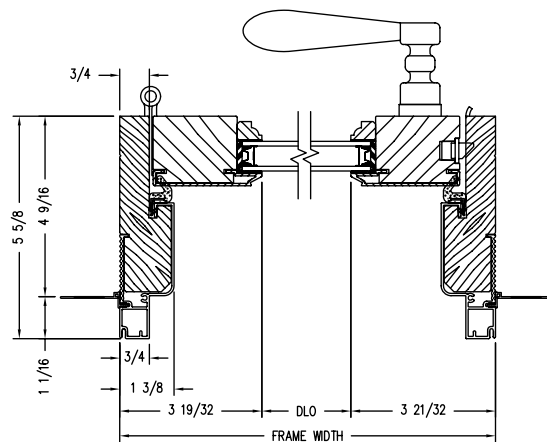

Horizontal Section

Shown with ovolo (colonial) glass stops.

PROPER INSTALLATION AND MAINTENANCE OF E-SERIES PRODUCTS IS ESSENTIAL TO ATTAIN OPTIMUM PERFORMANCE AND OPERATION. WRITTEN INSTALLATION INSTRUCTIONS THAT PROVIDE GUIDELINES FOR PROPER INSTALLATION ARE AVAILABLE BY VISITING [ANDERSENWINDOWS.COM](http://ANDERSENWINDOWS.COM). CUSTOM SIZES ARE AVAILABLE. CONTACT YOUR LOCAL SUPPLIER FOR MORE INFORMATION. DRAWINGS ARE NOT TO SCALE.

# HINGED PATIO DOORS

## Hinged Inswing Patio Doors (4 9/16" Jamb Depth)

**Inswing Sash-Set Transom**

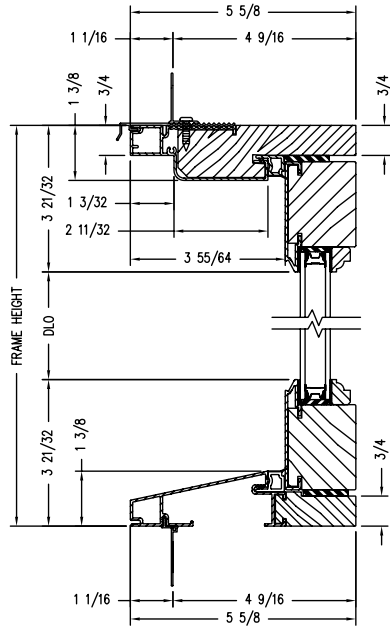

Vertical Section

**Inswing Direct-Set Transom**

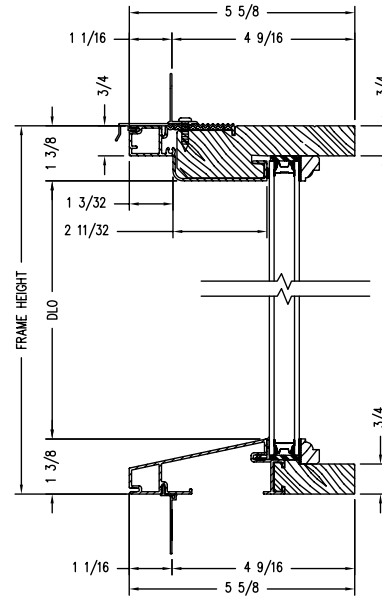

Vertical Section

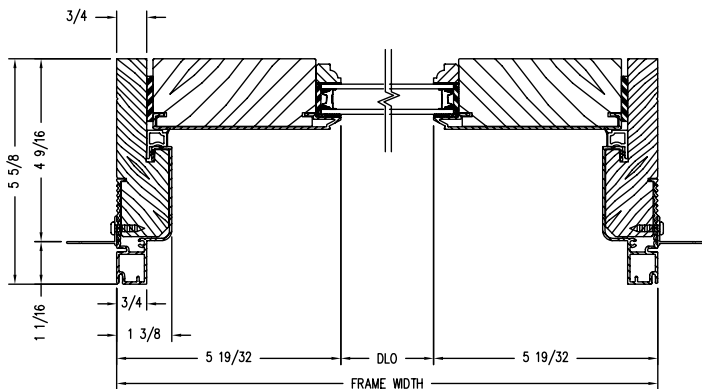

Horizontal Section

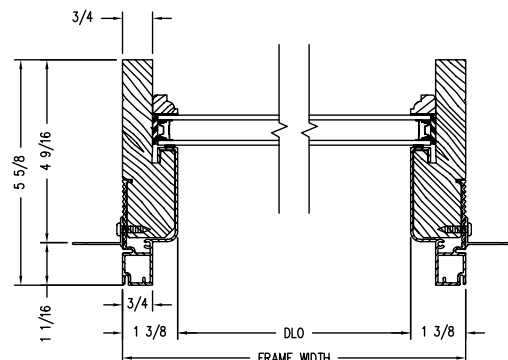

Horizontal Section

Shown with ovolo (colonial) glass stops.

PROPER INSTALLATION AND MAINTENANCE OF E-SERIES PRODUCTS IS ESSENTIAL TO ATTAIN OPTIMUM PERFORMANCE AND OPERATION. WRITTEN INSTALLATION INSTRUCTIONS THAT PROVIDE GUIDELINES FOR PROPER INSTALLATION ARE AVAILABLE BY VISITING [ANDERSENWINDOWS.COM](http://ANDERSENWINDOWS.COM). CUSTOM SIZES ARE AVAILABLE. CONTACT YOUR LOCAL SUPPLIER FOR MORE INFORMATION. DRAWINGS ARE NOT TO SCALE.

**Hinged Inswing Patio Doors (6 9/16" Jamb Depth)**

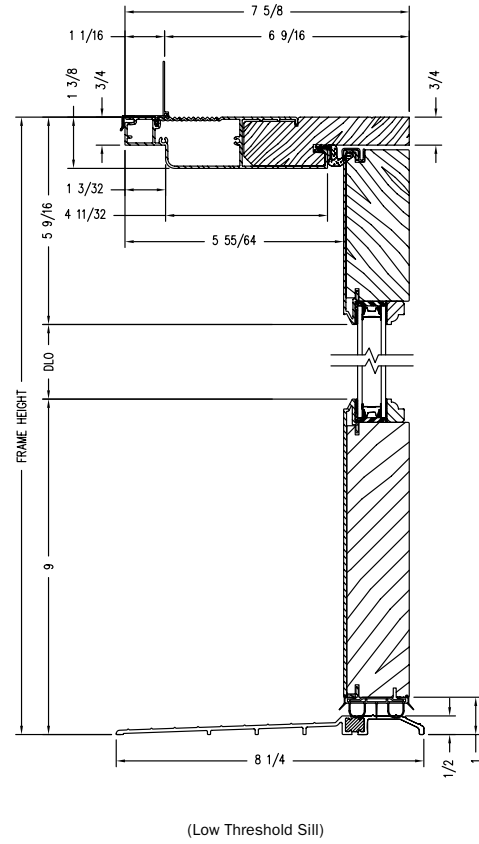
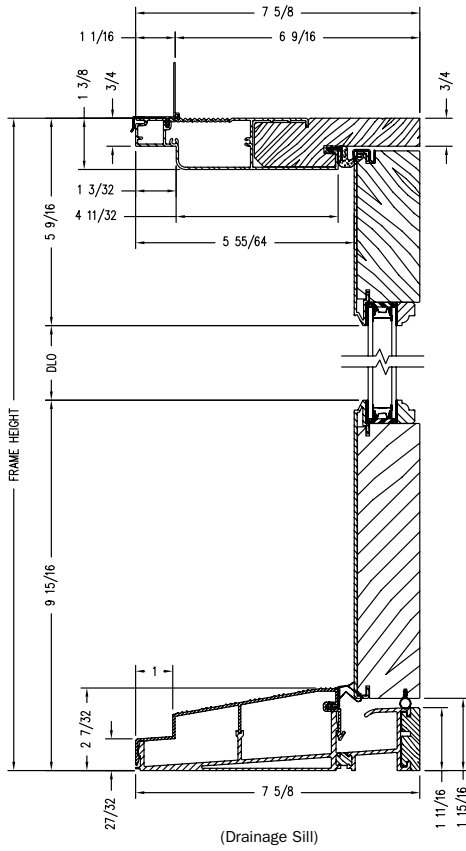

Vertical Section

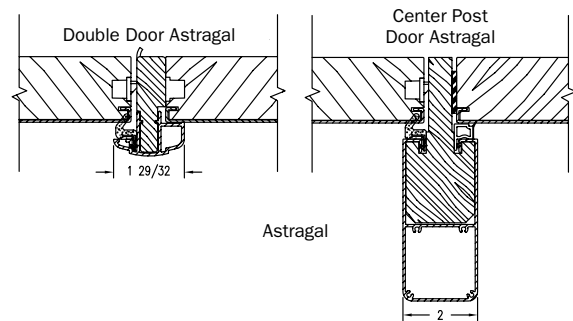
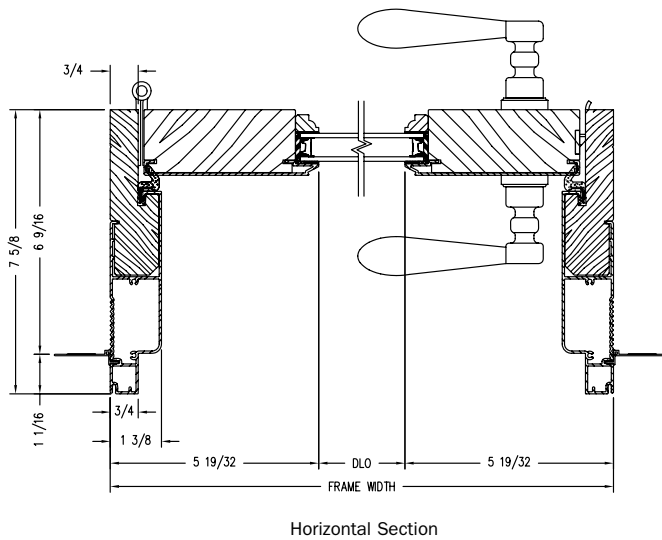

Shown with ovolo (colonial) glass stops.  
 French panel shown, also available with a contemporary panel.  
 Visit our website to see transoms and sidelight units with 6-9/16" jamb depth.

**PROPER INSTALLATION AND MAINTENANCE OF E-SERIES PRODUCTS IS ESSENTIAL TO ATTAIN OPTIMUM PERFORMANCE AND OPERATION. WRITTEN INSTALLATION INSTRUCTIONS THAT PROVIDE GUIDELINES FOR PROPER INSTALLATION ARE AVAILABLE BY VISITING ANDERSENWINDOWS.COM. CUSTOM SIZES ARE AVAILABLE. CONTACT YOUR LOCAL SUPPLIER FOR MORE INFORMATION. DRAWINGS ARE NOT TO SCALE.**

# HINGED PATIO DOORS

## Hinged Inswing Patio Door Handing (As Viewed From Exterior)

INSWING SINGLE DOOR



INSWING DOUBLE DOOR



INSWING CENTER POST DOOR

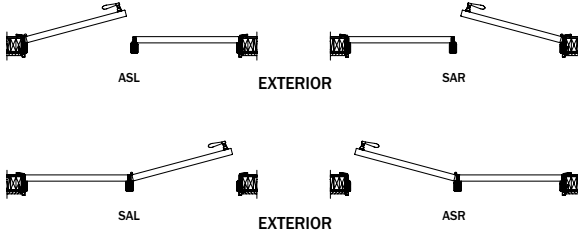

## Hinged Outswing Patio Door Handing (As Viewed From Exterior)

OUTSWING SINGLE DOOR

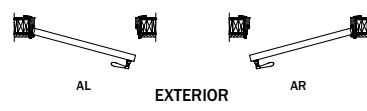

OUTSWING DOUBLE DOOR



## Double Hinged Outswing Patio Door Sizes

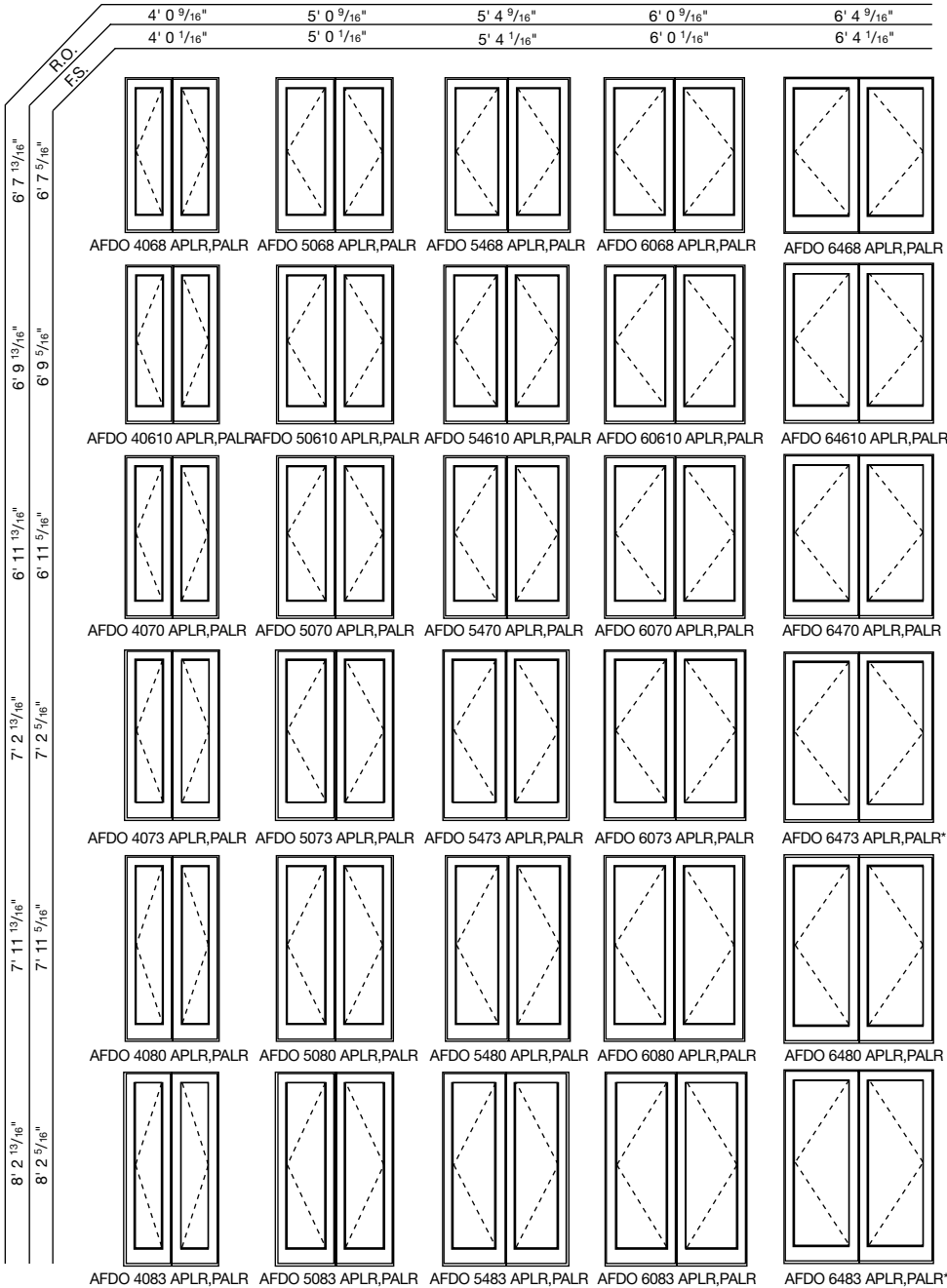

**NOTES**

- All doors and sidelights use safety/tempered glass.
- The minimum vertical joining material width for doors and sidelights is 1/2".
- \*Commercial sized door panels.
- See handing chart on page 132 for operation options.
- Use structural joining material when necessary or required by code.
- For a metric conversion in millimeters, multiply dimensions in inches by 25.4.

**FORMULA FOR COMBINATION DOORS**

The overall frame dimension (both width and height) is equal to the sum of the individual unit frame dimensions plus joining material dimension(s).  
 The overall rough opening (both width and height) is equal to the overall frame dimensions plus 1/4" on all sides.  
 Any unit within each combination can be operating or stationary except for direct-set units and transoms.

**Outswing Frame Height Formula**  
 (using Low Threshold Sill)  
 = Standard Outswing Frame Height – 7/16"

CUSTOM SIZES ARE AVAILABLE. CONTACT YOUR LOCAL SUPPLIER FOR MORE INFORMATION. DRAWINGS ARE NOT TO SCALE.

# HINGED PATIO DOORS

## Outswing Sash-Set Sidelight Sizes

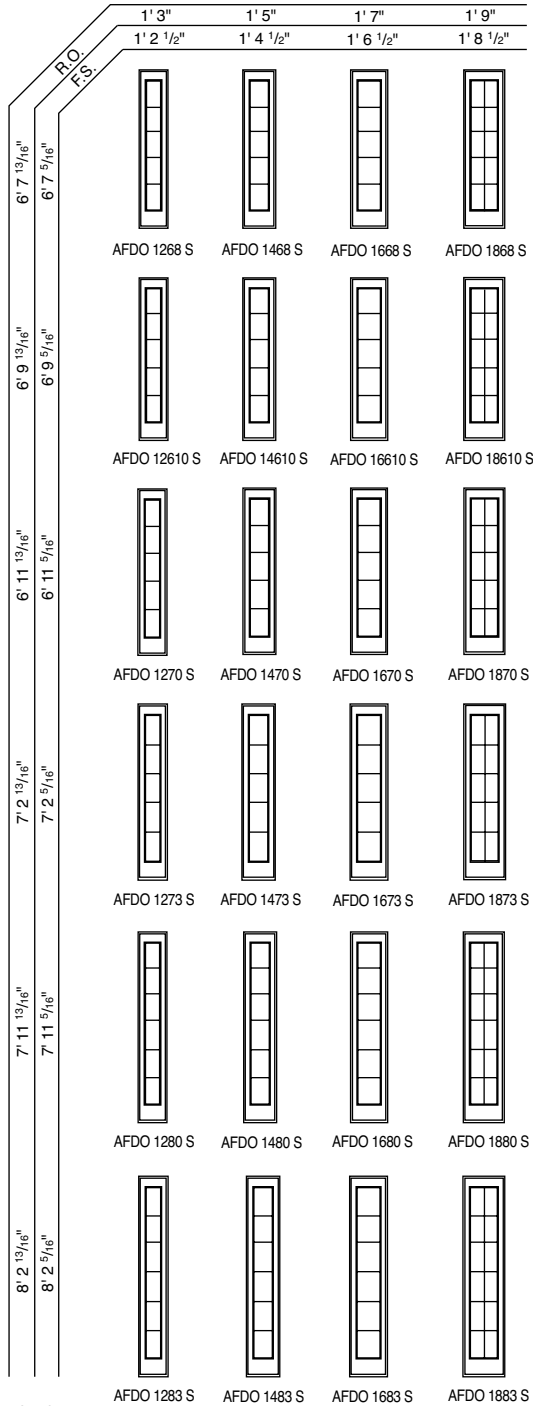

### NOTES

All doors and sidelights use safety/tempered glass.

The minimum vertical joining material width for doors and sidelights is 1/2". When joining a venting sidelight to a door, the minimum vertical joining material width is 2".

\*Commercial sized door panels.

See handing chart on page 132 for operation options.

Use structural joining material when necessary or required by code.

The light patterns illustrated apply to removable interior wood grilles, Full Divided Light, Simulated Divided Light, Decorelle 100, 150 and 400 and Finelight™ Grilles-Between-the-Glass. All removable interior wood grilles will be installed in the units unless otherwise specified.

**FOR WINDOWS GREATER THAN 30 SQUARE FEET OR RATED HIGHER THAN PG50, ONE OF THESE THREE INSTALLATION METHODS IS REQUIRED:**  
**A) THROUGH THE JAMB B) ALUMINUM INSTALLATION FLANGE OR C) INSTALLATION CLIPS.**  
**ADDITIONAL CUSTOM SIZES ARE AVAILABLE. CONTACT YOUR LOCAL SUPPLIER FOR MORE INFORMATION. DRAWINGS ARE NOT TO SCALE.**

## Single Hinged Outswing Patio Door & Sidelight Sizes

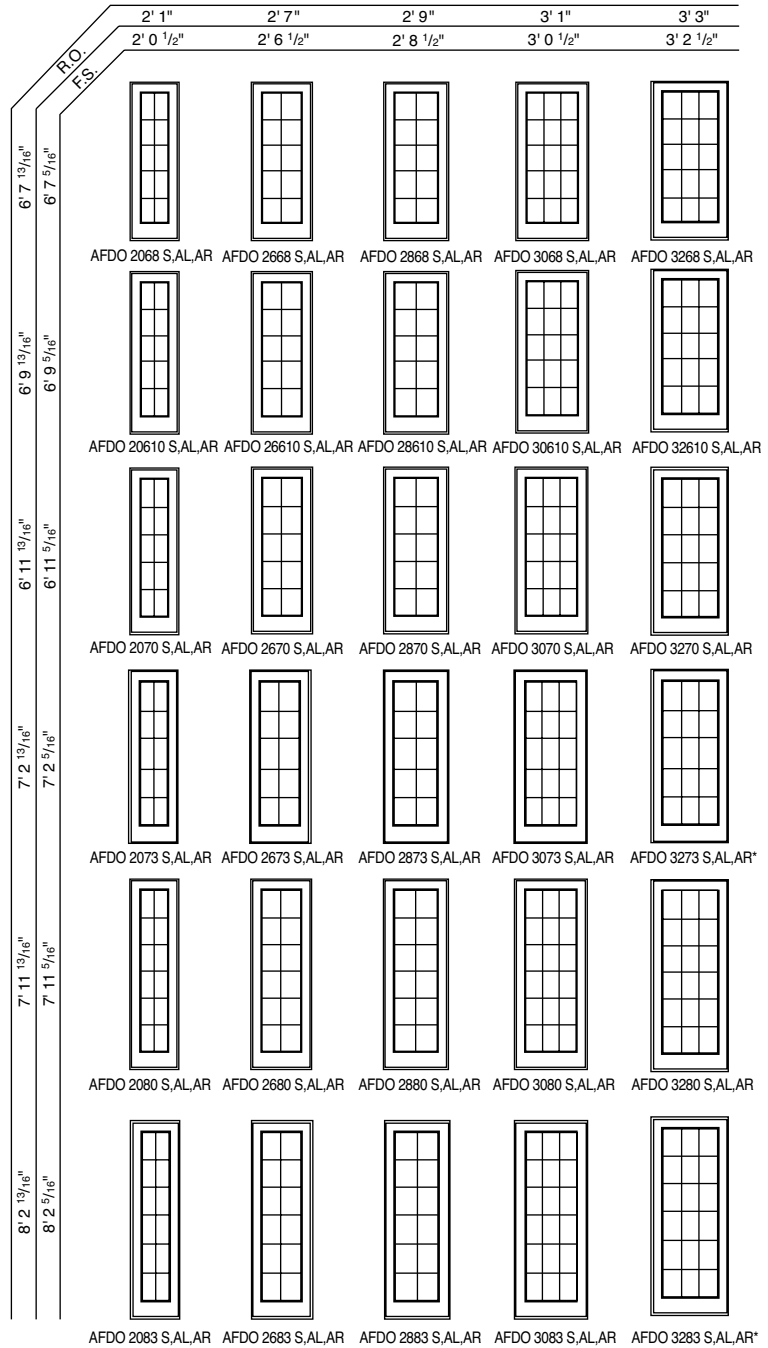

For a metric conversion in millimeters, multiply dimensions in inches by 25.4.

### Outswing Frame Height Formula (using Low Threshold Sill)

$$= \text{Standard Outswing Frame Height} - 7/16''$$

### FORMULA FOR COMBINATION DOORS

The overall frame dimension (both width and height) is equal to the sum of the individual unit frame dimensions plus joining material dimension(s).

The overall rough opening (both width and height) is equal to the overall frame dimensions plus 1/4" on all sides.

Any unit within each combination can be operating or stationary except for direct-set units and transoms.



### Hinged Outswing Patio Door Sash-Set Transom Sizes

	2' 1" 2' 0 1/2"	2' 7" 2' 6 1/2"	2' 9" 2' 8 1/2"	3' 1" 3' 0 1/2"	3' 3" 3' 2 1/2"	4' 0 9/16" 4' 0 1/16"	5' 0 9/16" 5' 0 1/16"	5' 4 9/16" 5' 4 1/16"	6' 0 9/16" 6' 0 1/16"	6' 4 9/16" 6' 4 1/16"
1' 2" R.O. F.S.										
1' 4"										
1' 6"										
1' 8"										
2' 0"										
2' 4"										
2' 6"										
2' 8"										
3' 0"										

### Hinged Outswing Patio Door Sash-Set Transom Sizes

	1' 3" 1' 2 1/2"	1' 5" 1' 4 1/2"	1' 7" 1' 6 1/2"	1' 9" 1' 8 1/2"
1' 2" R.O. F.S.				
1' 4"				
1' 6"				
1' 8"				
2' 0"				

### Hinged Outswing Patio Door Sash-Set Transom Sizes

	1' 3" 1' 2 1/2"	1' 5" 1' 4 1/2"	1' 7" 1' 6 1/2"	1' 9" 1' 8 1/2"
1' 2" R.O. F.S.				
2' 4"				
2' 6"				
2' 8"				
3' 0"				

**NOTES**

If glass is positioned within 18" of the finished floor, safety/tempered glass may be required. Local codes may differ. Verify tempered glass requirements with your local building code official.

Use structural joining material when necessary or required by code.

The light patterns illustrated apply to removable interior wood grilles, Full Divided Light, Simulated Divided Light, Decorelle 100, 150 and 400 and Finelight™ Grilles-Between-the-Glass. All removable interior wood grilles will be installed in the units unless otherwise specified. The staggered light patterns illustrated align with light patterns in double doors. Other light patterns are available upon request.

For a metric conversion in millimeters, multiply dimensions in inches by 25.4.

**FORMULA FOR COMBINATION DOORS**

The overall frame dimension (both width and height) is equal to the sum of the individual unit frame dimensions plus joining material dimension(s).

The overall rough opening (both width and height) is equal to the overall frame dimensions plus 1/4" on all sides.

Any unit within each combination can be operating or stationary except for direct-set units and transoms.

**FOR WINDOWS GREATER THAN 30 SQUARE FEET OR RATED HIGHER THAN PG50, ONE OF THESE THREE INSTALLATION METHODS IS REQUIRED:  
A) THROUGH THE JAMB B) ALUMINUM INSTALLATION FLANGE OR C) INSTALLATION CLIPS.  
ADDITIONAL CUSTOM SIZES ARE AVAILABLE. CONTACT YOUR LOCAL SUPPLIER FOR MORE INFORMATION. DRAWINGS ARE NOT TO SCALE.**

E-Series Hinged Patio Doors

# HINGED PATIO DOORS

## Hinged Outswing Patio Door Direct-Set Transom Sizes (Specialty Frame)

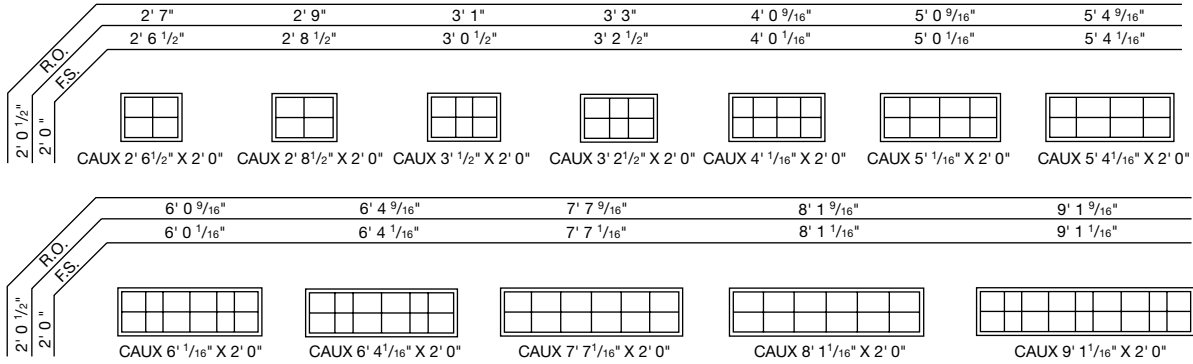

## Hinged Outswing Patio Door Direct-Set Elliptical Sizes (Specialty Frame)

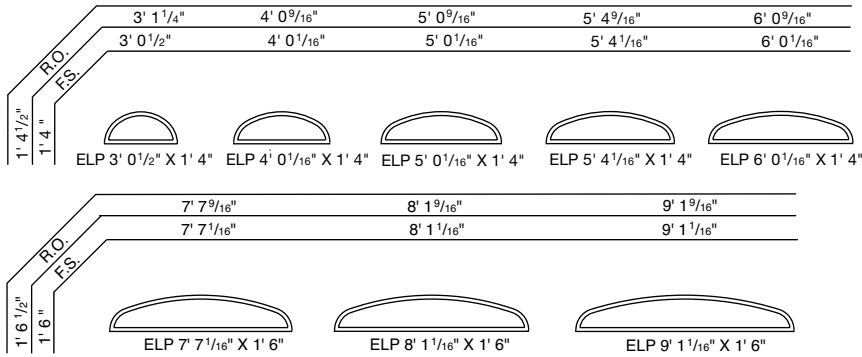

## Hinged Outswing Patio Door Direct-Set Half Circle Sizes (Specialty Frame)

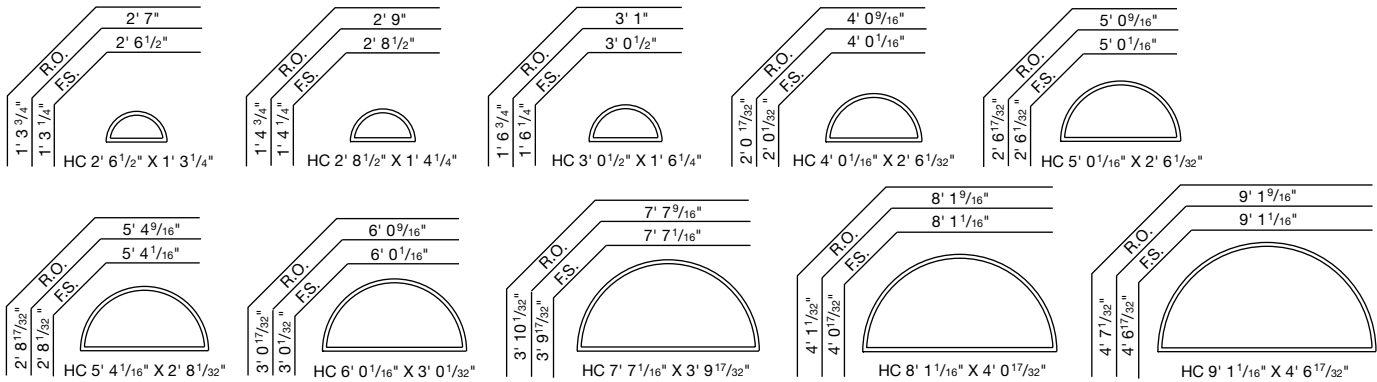

### NOTES

If glass is positioned within 18" of the finished floor, safety/tempered glass may be required. Local codes may differ. Verify tempered glass requirements with your local building code official.

- 2' 6-1/2" wide transoms are used above 2668, 26610 or 2680 Hinged Outswing Patio Doors.
- 2' 8-1/2" wide transoms are used above 2868, 28610 or 2880 Hinged Outswing Patio Doors.
- 3' 0-1/2" wide transoms are used above 3068, 30610 or 3080 Hinged Outswing Patio Doors.
- 4' 0" wide transoms are used above 4068, 40610 or 4080 Hinged Outswing Patio Doors.
- 5' 0" wide transoms are used above 5068, 50610 or 5080 Hinged Outswing Patio Doors.
- 5' 4" wide transoms are used above 5468, 54610 or 5480 Hinged Outswing Patio Doors.
- 6' 0" wide transoms are used above 6068, 60610 or 6080 Hinged Outswing Patio Doors.
- 7' 7" wide transoms are used above 5068/50610/5080 Hinged Outswing Patio Doors with 2668/26610/2680 Sidelights.
- 8' 1" wide transoms are used above 5468/54610/5480 Hinged Outswing Patio Doors with 2868/28610/2880 Sidelights.
- 9' 1" wide transoms are used above 6068/60610/6080 Hinged Outswing Patio Doors with 3068/30610/3080 Sidelights.

The light patterns illustrated apply to removable interior wood grilles, Full Divided Light, Simulated Divided Light, Decorelle 100, 150 and 400 and Finelight™ Grilles-Between-the-Glass. All removable interior wood grilles will be installed in the units unless otherwise specified. The staggered light patterns illustrated align with light patterns in double doors. Other light patterns are available upon request.

**FOR WINDOWS GREATER THAN 30 SQUARE FEET OR RATED HIGHER THAN PG50, ONE OF THESE THREE INSTALLATION METHODS IS REQUIRED:  
A) THROUGH THE JAMB B) ALUMINUM INSTALLATION FLANGE OR C) INSTALLATION CLIPS.  
ADDITIONAL CUSTOM SIZES ARE AVAILABLE. CONTACT YOUR LOCAL SUPPLIER FOR MORE INFORMATION. DRAWINGS ARE NOT TO SCALE.**

**Single Arch Outswing Patio Door & Sidelight Sizes**

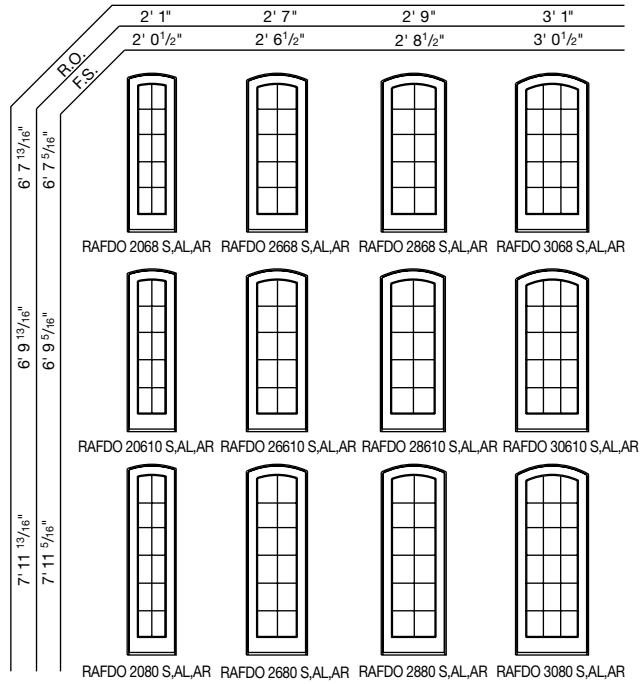

**NOTES**

All doors and sidelights use safety/tempered glass.

Single doors have a 3' 0" radius.

Double doors have a 5' 0" radius.

See handing chart on page 132 for operation options.

Use structural joining material when necessary or required by code.

The light patterns illustrated apply to removable interior wood grilles, Full Divided Light, Simulated Divided Light, Decorelle 100, 150 and 400 and Finelight™ Grilles-Between-the-Glass. All removable interior wood grilles will be installed in the units unless otherwise specified.

For a metric conversion in millimeters, multiply dimensions in inches by 25.4.

**Outswing Frame Height Formula  
(using Low Threshold Sill)**

= Standard Outswing Frame Height – 7/16"

**FORMULA FOR COMBINATION DOORS**

The overall frame dimension (both width and height) is equal to the sum of the individual unit frame dimensions plus joining material dimension(s).

The overall rough opening (both width and height) is equal to the overall frame dimensions plus 1/4" on all sides.

Any unit within each combination can be operating or stationary except for direct-set units and transoms.

**Double Arch Outswing Patio Door Sizes**

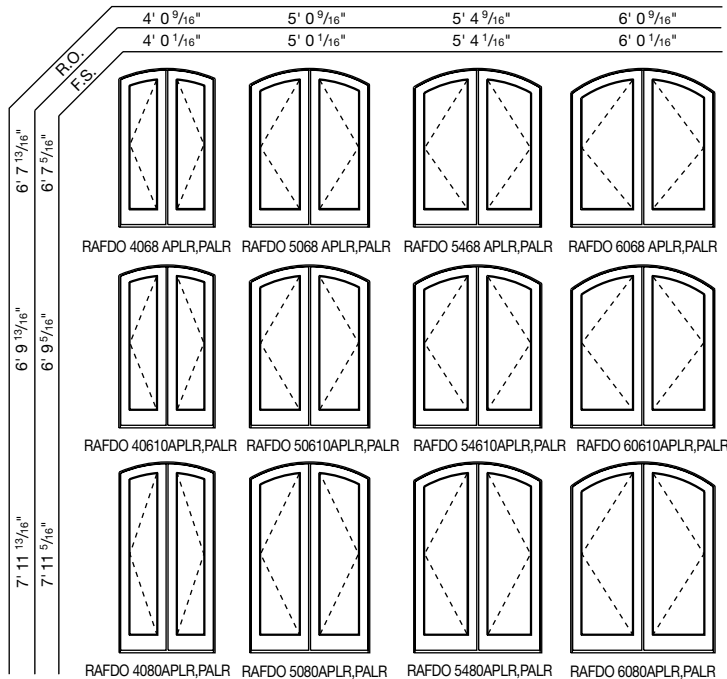

CUSTOM SIZES ARE AVAILABLE. CONTACT YOUR LOCAL SUPPLIER FOR MORE INFORMATION. DRAWINGS ARE NOT TO SCALE.

# HINGED PATIO DOORS

## 3-Wide Arch Outswing Patio Door & Sidelight Sizes

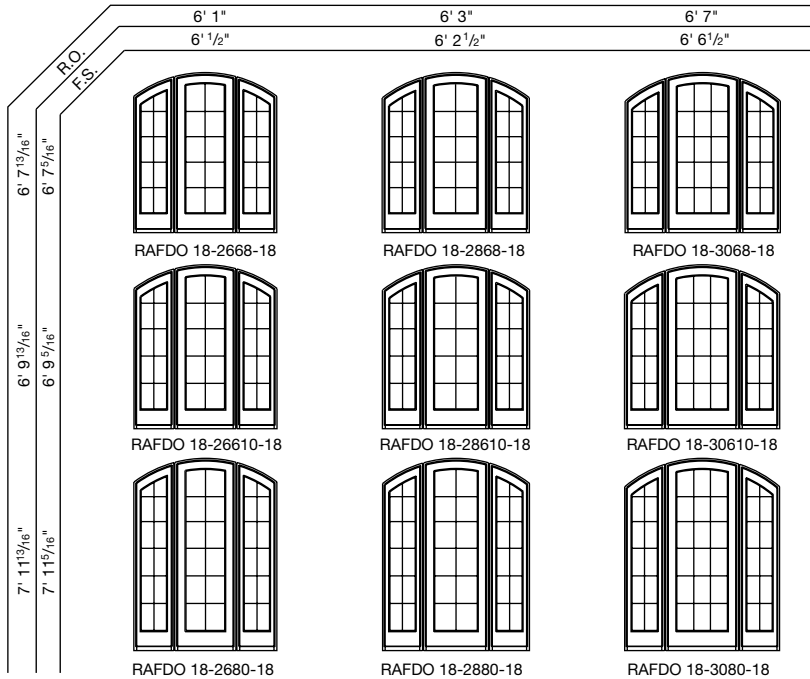

### NOTES

All doors and sidelights use safety/tempered glass.

3-wide doors have a 5'0" radius.

CPS doors shown with optional mid-rail.

See handing chart on page 132 for operation options.

Use structural joining material when necessary or required by code.

The light patterns illustrated apply to removable interior wood grilles, Full Divided Light, Simulated Divided Light, Decorelle 100, 150 and 400 and Finelight™ Grilles-Between-the-Glass. All removable interior wood grilles will be installed in the units unless otherwise specified.

For a metric conversion in millimeters, multiply dimensions in inches by 25.4.

### Outswing Frame Height Formula\* (using Low Threshold Sill)

$$= \text{Standard Outswing Frame Height} - 7/16''$$

\*Does not apply to Concealed Panic System (CPS) doors

### FORMULA FOR COMBINATION DOORS

The overall frame dimension (both width and height) is equal to the sum of the individual unit frame dimensions plus joining material dimension(s).

The overall rough opening (both width and height) is equal to the overall frame dimensions plus 1/4" on all sides.

Any unit within each combination can be operating or stationary except for arch sidelights.

## Concealed Panic System (CPS) Door Sizes

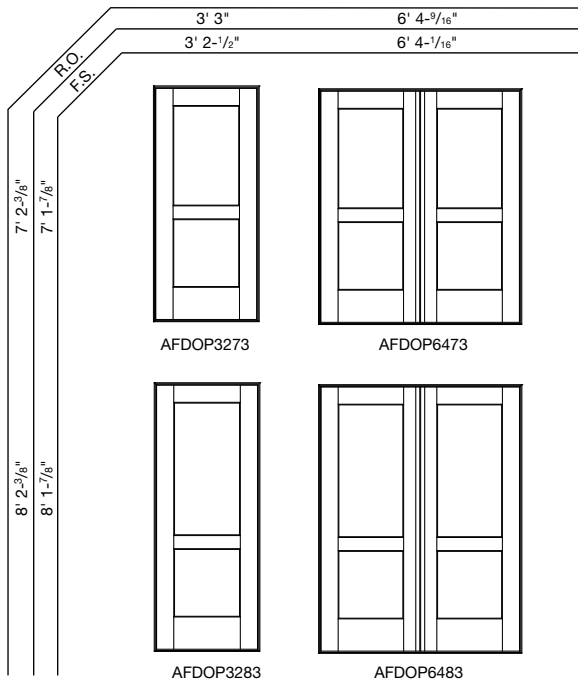

**Hinged Outswing Patio Doors**

**Hinged Outswing Patio Door**

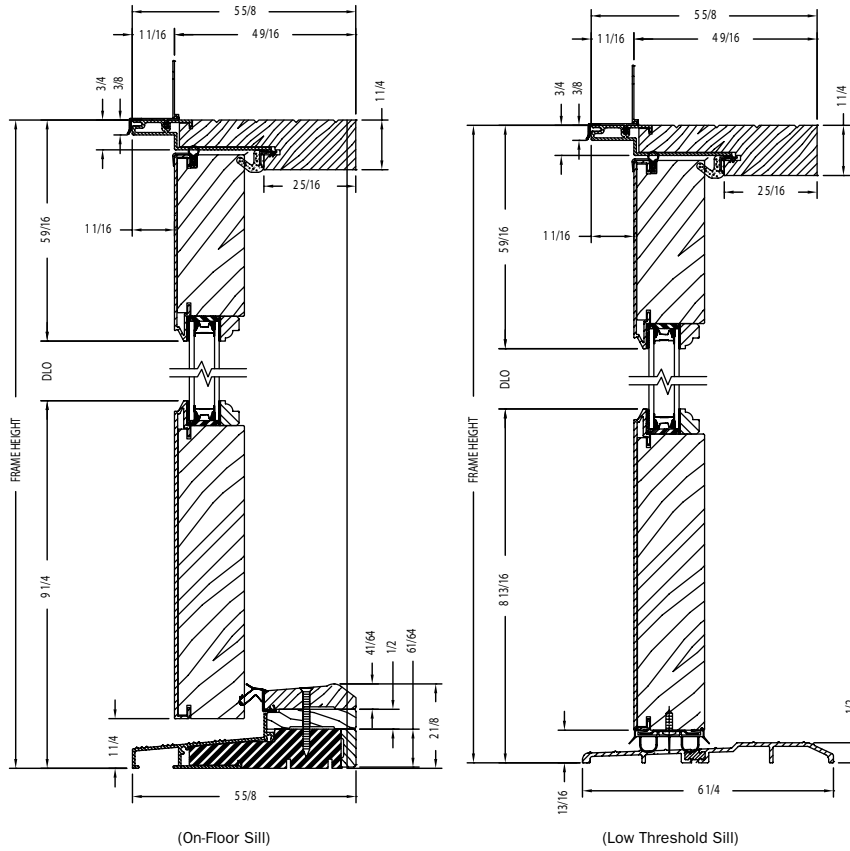

Vertical Section

**Astragal**

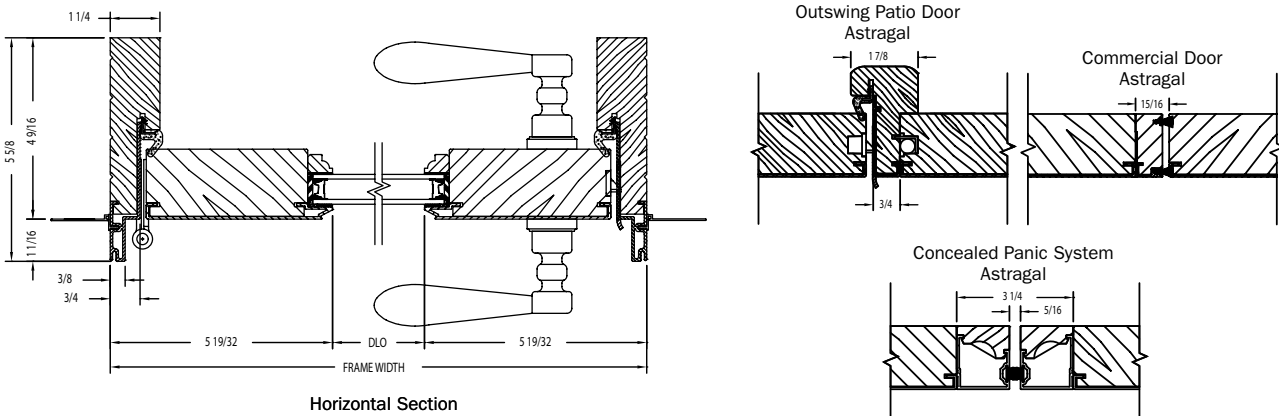

Shown with ovolo (colonial) glass stops.  
French panel shown, also available with a contemporary panel.

**PROPER INSTALLATION AND MAINTENANCE OF E-SERIES PRODUCTS IS ESSENTIAL TO ATTAIN OPTIMUM PERFORMANCE AND OPERATION. WRITTEN INSTALLATION INSTRUCTIONS THAT PROVIDE GUIDELINES FOR PROPER INSTALLATION ARE AVAILABLE BY VISITING ANDERSENWINDOWS.COM. CUSTOM SIZES ARE AVAILABLE. CONTACT YOUR LOCAL SUPPLIER FOR MORE INFORMATION. DRAWINGS ARE NOT TO SCALE.**

## Hinged Outswing Patio Doors

### Outswing Sash-Set Sidelight

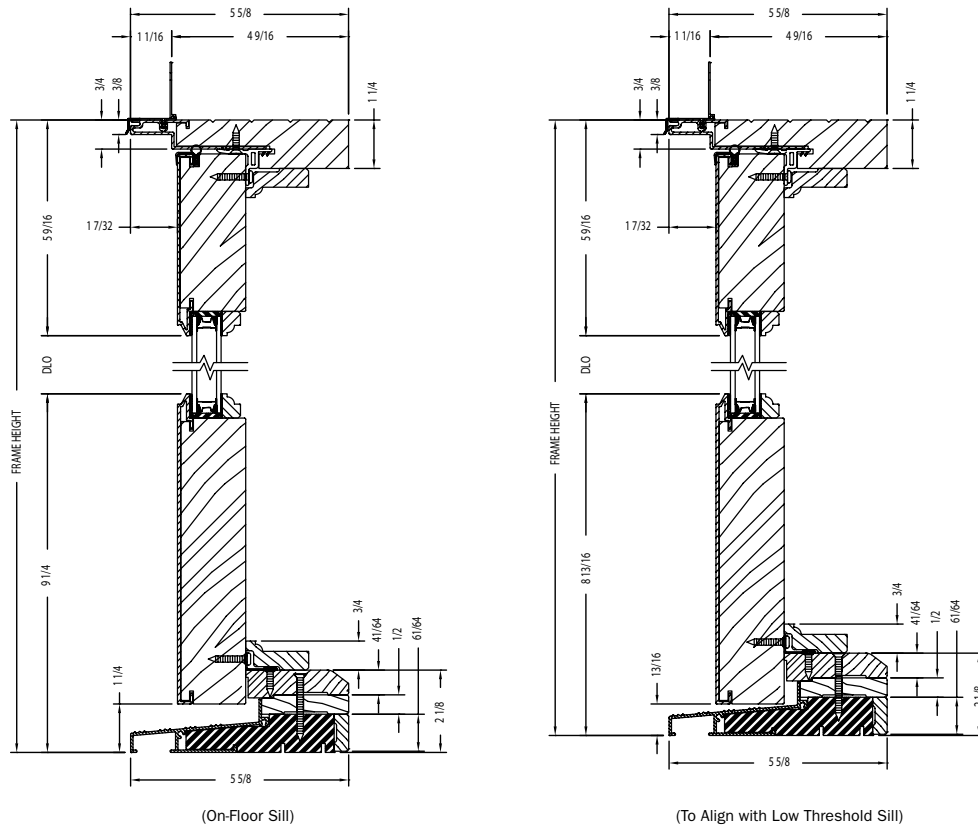

Vertical Section

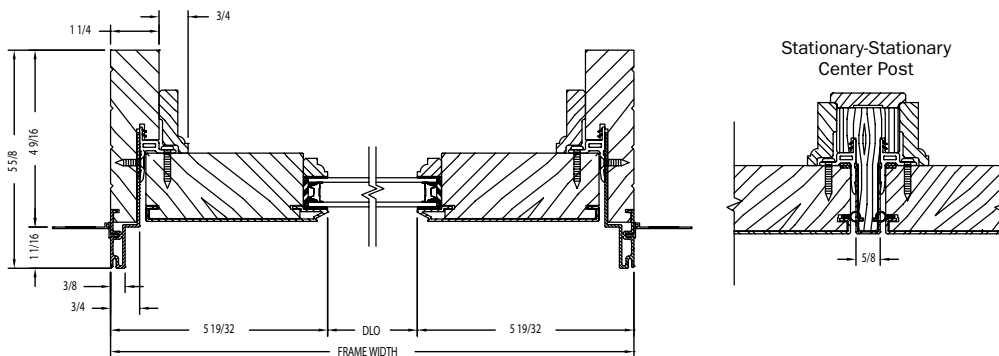

Horizontal Section

Shown with ovolo (colonial) glass stops.

PROPER INSTALLATION AND MAINTENANCE OF E-SERIES PRODUCTS IS ESSENTIAL TO ATTAIN OPTIMUM PERFORMANCE AND OPERATION. WRITTEN INSTALLATION INSTRUCTIONS THAT PROVIDE GUIDELINES FOR PROPER INSTALLATION ARE AVAILABLE BY VISITING [ANDERSENWINDOWS.COM](http://ANDERSENWINDOWS.COM). CUSTOM SIZES ARE AVAILABLE. CONTACT YOUR LOCAL SUPPLIER FOR MORE INFORMATION. DRAWINGS ARE NOT TO SCALE.

**Hinged Outswing Patio Doors**

**Outswing Venting Sidelight**

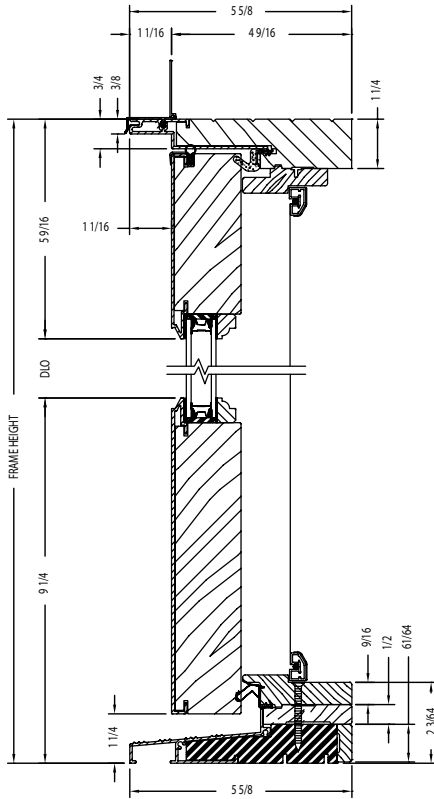

Vertical Section

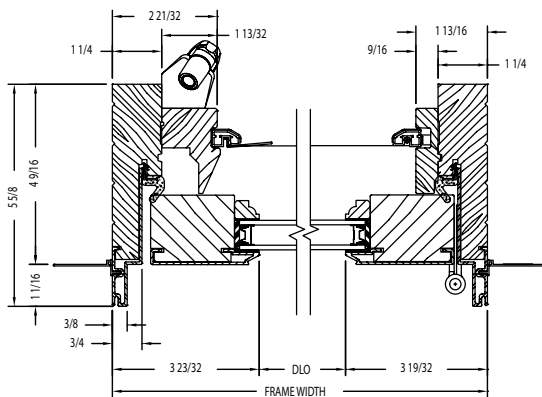

Horizontal Section

**Outswing Sash-Set Transom**

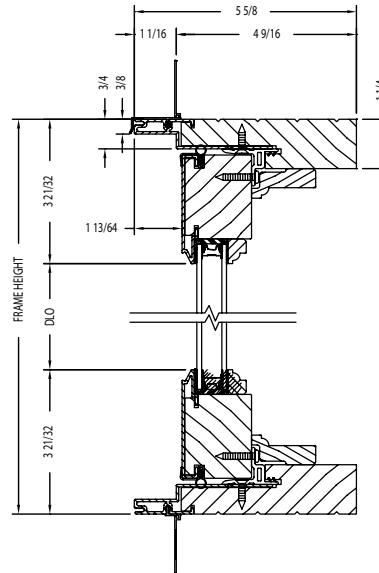

Vertical Section

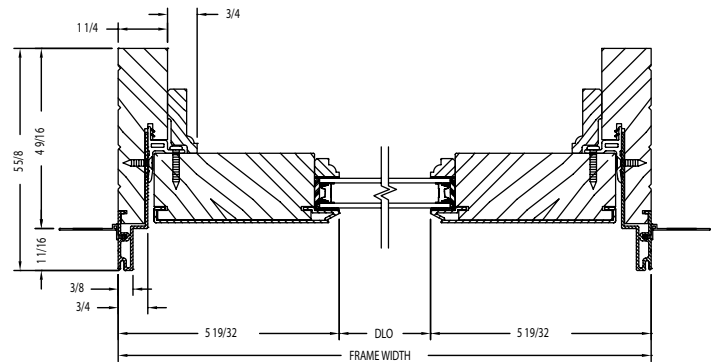

Horizontal Section

Shown with ovolo (colonial) glass stops.

PROPER INSTALLATION AND MAINTENANCE OF E-SERIES PRODUCTS IS ESSENTIAL TO ATTAIN OPTIMUM PERFORMANCE AND OPERATION. WRITTEN INSTALLATION INSTRUCTIONS THAT PROVIDE GUIDELINES FOR PROPER INSTALLATION ARE AVAILABLE BY VISITING [ANDERSENWINDOWS.COM](http://ANDERSENWINDOWS.COM). CUSTOM SIZES ARE AVAILABLE. CONTACT YOUR LOCAL SUPPLIER FOR MORE INFORMATION. DRAWINGS ARE NOT TO SCALE.

# GLIDING PATIO DOORS

Choose from our French panels with 8" or 12" bottom rail options, or one of two narrower panel profiles for a more contemporary look, to create an open view to the outside. E-Series gliding patio doors feature multi-point locking hardware for a firm, secure seal and tandem ball bearing rollers for smooth operation.

---

<b>Gliding Overview</b> .....	<b>144</b>
Panel Labeling & Handing .....	146
Gliding Sizing	
Stationary & Two-Panel Doors .....	147
Four-Panel Doors .....	147
Specialty Transom .....	148
Gliding Details .....	149
French Gliding Sizing	
Stationary & Two-Panel Doors .....	150
Four-Panel Doors .....	151
Specialty Transom .....	152
French Gliding Details .....	153
Installation Materials .....	154
Product Performance .....	158







# GLIDING PATIO DOORS

## FEATURES

### GLIDING PATIO DOORS

#### FRAME & PANEL

**A** Select wood components are kiln dried and treated with water/insect repellent and preservative. Interior wood surfaces are available in pine, mixed grain Douglas fir, cherry, hickory, mahogany\*, maple, oak, walnut, alder or vertical grain Douglas fir. Interior surfaces are available unfinished or factory primed. Factory-applied finishes are available in a variety of stain and paint options.

**B** Wood components are fitted with aluminum extrusions on the exterior. 50 exterior colors that meet AAMA 2604 and 2605 specifications are available, as well as custom colors. Also available is a selection of seven exterior anodized options.

The frame consists of foam-filled leaf weatherstrip on the exterior creating a weather-resistant pocket for the door panel. A dual weatherstrip seal on the interlock is fitted between the fixed and operating meeting stiles.



French Gliding Patio Door

Vinyl installation flanges are pre-applied into a kerf on the frame exterior to facilitate installation. Optional aluminum flanges and metal installation clips are available. Standard jamb depth is 4 7/16" for gliding patio doors.

#### SILL

**C** A durable fiberglass sill is an excellent thermal barrier. Stainless steel roller caps provide smooth operation of the door panel. Available in dark bronze or gray.

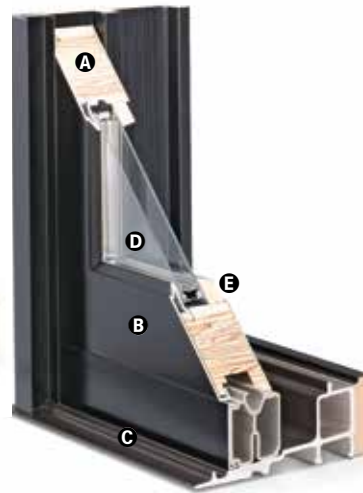

Gliding Patio Door

#### GLASS

**D** High-Performance Low-E4® glass with a low-conductivity spacer. Triple-pane glass, tinted, clear dual-pane, high-altitude glass and other special glazing options are available.

**E** Glass is fixed in place from the interior with wood stops that can be removed for easy reglazing if necessary. Glass stops available in ovolo (colonial) and contemporary profiles.

#### HARDWARE

##### Steel Rollers

Operating panel consists of two tandem ball bearing steel roller assemblies. Stainless steel roller assemblies are available as an option.



##### Multi-Point Locking System

The multi-point locking system features a unique reachout design that pulls the door panel tightly closed for a weather-tight seal and enhanced security.



## ACCESSORIES Sold Separately

#### HARDWARE

##### Auxiliary Foot Lock

An enhanced foot lock is discreetly positioned on the side of the panel. Foot lock provides an extra measure of security when door is in locked position. Available in finish options to complement handle sets.



Additional hardware options such as exterior keyed locks and more are also available.

#### SENSORS

VeriLock® sensors and open/closed sensors are available for gliding patio doors. See page 27 for Smart Home options.

#### INSECT SCREENS

##### Top-Hung Gliding Insect Screens

Charcoal fiberglass screen mesh fits into an aluminum frame available in 50 exterior colors. Aluminum screen mesh is also available as an option.

##### Retractable Insect Screens

The retractable insect screen has charcoal fiberglass screen mesh. Insect screen retracts when not needed, providing an unobstructed view through the glass. Available in 50 exterior colors. See page 24 for more information on our insect screen options.

#### PRIVACY OPTIONS

##### Blinds-Between-the-Glass



A 5/8" aluminum slat blind mounted between two panes of insulated glass in a dust-free environment. Available in white, tan and almond. Blinds are magnetically controlled and can be tilted or raised and lowered with one cord.\*\* Not available on arch patio doors.

#### GRILLES

##### Full Divided Light

Permanent interior and exterior grilles with grille spacer bars between two panes of glass. Available in 5/8", 7/8", 1 1/8", 1 1/2", or 2 1/4" widths and ovolo or contemporary profiles. The ovolo profile is shown below, not all widths are shown.

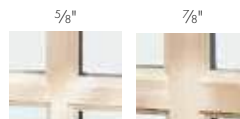

##### Simulated Divided Light

Permanent exterior and interior grilles without grille spacer bars. Available in 5/8", 7/8", 1 1/8", 1 1/2", or 2 1/4" widths and ovolo or contemporary profiles. The ovolo profile is shown below, not all widths are shown.



##### Finelight™

##### Grilles-Between-the-Glass

Available in 5/8" flat or 1" contoured aluminum profiles. Two-tone colors of pebble tan/colony white, sierra bronze/colony white or forest green/colony white are available on the 1" profile.



5/8" Flat 1" Contoured

##### Removable Interior Wood Grilles

Removable interior wood grilles are available in a 7/8" width and ovolo or contemporary profiles. Optional surround for removable grille and permanent exterior grilles also available.



7/8"

See page 22 for more information on grilles.

\*Actual wood species is either Sapele or Sipo, both non-endangered species grown in Africa, with color and characteristics similar to Central American mahoganies.

\*\*Not all sizes are retractable. See your local dealer for details.

**EXTERIOR & INTERIOR OPTIONS**

**EXTERIOR COLORS** 50 exterior colors, 7 anodized finishes and custom colors. See exterior colors on page 11.

**INTERIOR WOOD SPECIES**

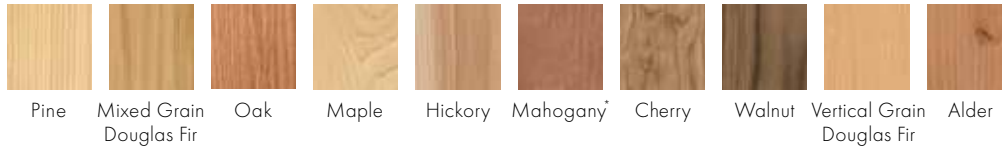

Naturally occurring variations in grain, color and texture of wood make each window one of a kind.

All factory-finished options are shown on pine.

Painted options available on pine. Dark bronze and black painted options available on pine or maple.

Anodized silver painted option available on maple only.

Interior custom stains, paints and color matching available.

**FACTORY-FINISHED INTERIORS**

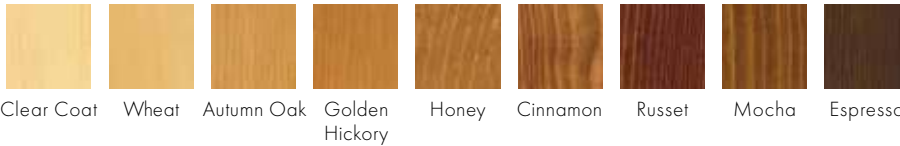

**INTERIOR PAINTED OPTIONS**



**HARDWARE OPTIONS**



<b>YUMA®</b> Distressed Bronze <b>Distressed Nickel</b>	<b>ENCINO®</b> <b>Distressed Bronze</b> Distressed Nickel	<b>NEWBURY®</b> Antique Brass Bright Brass Brushed Chrome <b>Oil Rubbed Bronze</b> Polished Chrome Satin Nickel	<b>ANVERS®</b> Bright Brass Oil Rubbed Bronze <b>Satin Nickel</b>	<b>COVINGTON™</b> Antique Brass <b>Bright Brass</b> Oil Rubbed Bronze	<b>WHITMORE®</b> <b>Antique Brass</b> Bright Brass Oil Rubbed Bronze Satin Nickel	<b>ALBANY</b> Black <b>Gold Dust</b> Stone White	<b>TRIBECA®</b> Stone <b>White</b>
---	---	---	--	--	---	--	--

Bold name denotes finish shown.

**HARDWARE FINISHES**

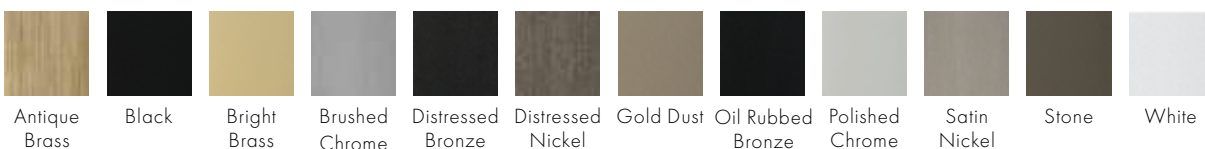

Oil rubbed bronze is a "living" finish that will change with time and use.

\*Actual wood species is either Sapele or Sipo, both non-endangered species grown in Africa, with color and characteristics similar to Central American mahoganies.

Mix and match interior and exterior style and finish options are available.

Bright brass and satin nickel finishes feature a 10-year limited warranty.

Tribeca and Albany hardware are zinc diecast with powder-coated durable finish, other hardware is solid forged brass.

Printing limitations prevent exact replication of colors and finishes. See your Andersen supplier for actual color and finish samples.

## Gliding Patio Door Panel Labeling

### Door Panel Options

Andersen® E-Series offers both contemporary and French panel styles to complement traditional or modern architecture.

Gliding Patio Door Contemporary Panels

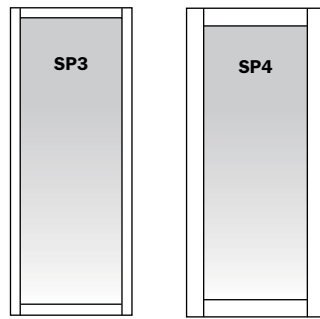

2 3/4" stiles & rails

4 1/16" stiles & rails

Gliding Patio Door French Panels

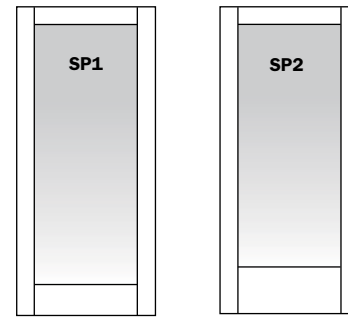

4 1/16" stiles, 4 1/16" top rail & 8" bottom rail

4 1/16" stiles, 4 1/16" top rail & 12" bottom rail

## Gliding Patio Door Handing

The door handing and order designation noted below is consistent with the handing of other Andersen® gliding patio doors and is used throughout the remainder of the gliding patio doors section.

### Identification

As viewed from the exterior, either the left or the right panel operates. The arrow designates the direction of panel operation. Stationary (S) doors can be used as an individual unit or as a sidelight.

## Gliding Patio Doors & French Gliding Patio Doors

### Handing Options

#### Single Door

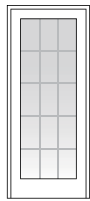

S

Stationary Panel

#### 2-Panel Door

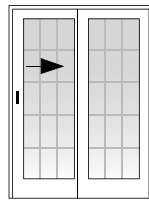

LS

Left (L) panel is operating, right panel is stationary (S).

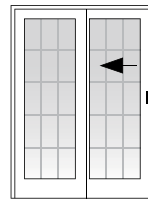

SR

Left panel is stationary (S), right (R) panel is operating.

#### 4-Panel Door

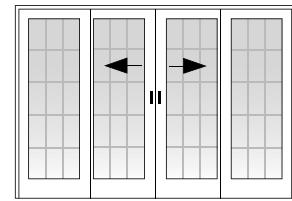

Astragal is attached on third panel from the left (as viewed from the exterior)

### Order Designation Description

	As Viewed From Exterior
Stationary	S
2-Panel Door	SR
	LS
4-Panel Door	—

**Gliding Patio Door Sizes**

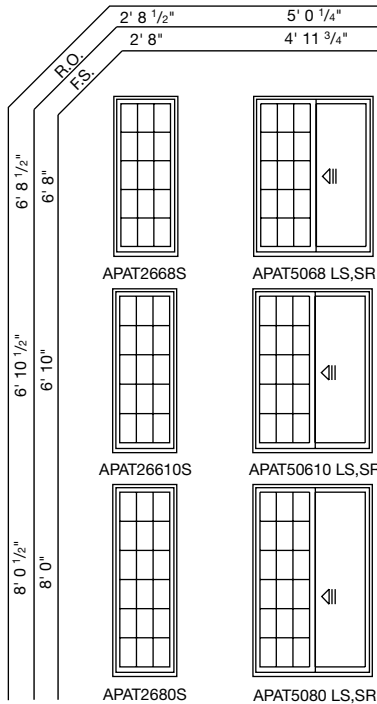

**Gliding Patio Door Sizes**

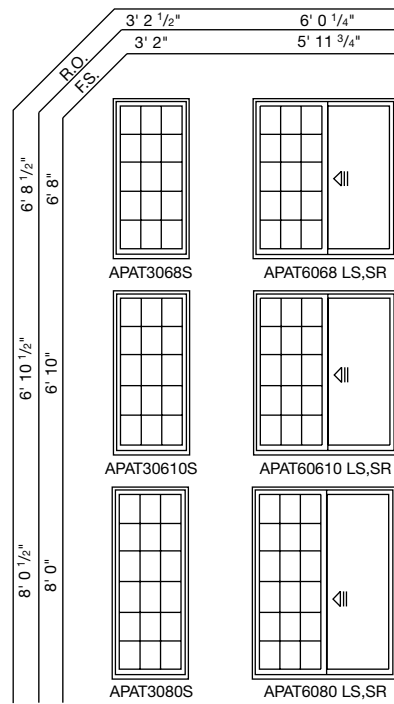

**NOTES**

All doors and sidelights use safety/tempered glass.

Astragal is applied to third panel from the left (as viewed from the exterior) on a 4-panel gliding patio door.

\*\*4-panel doors are shipped knocked down and require field assembly because of size and weight.

Use structural joining material when necessary or required by code.

The light patterns illustrated apply to removable interior wood grilles, Full Divided Light, Simulated Divided Light, Decorelle 100, 150 and 400 and Finelight™ Grilles-Between-the-Glass. All removable interior wood grilles will be installed in the units unless otherwise specified.

For a metric conversion in millimeters, multiply dimensions in inches by 25.4.

**FORMULA FOR COMBINATION DOORS**

The overall frame dimension (both width and height) is equal to the sum of the individual unit frame dimensions plus joining material dimension(s).

The overall rough opening (both width and height) is equal to the overall frame dimensions plus 1/4" on all sides.

**Gliding Patio Door Sizes**

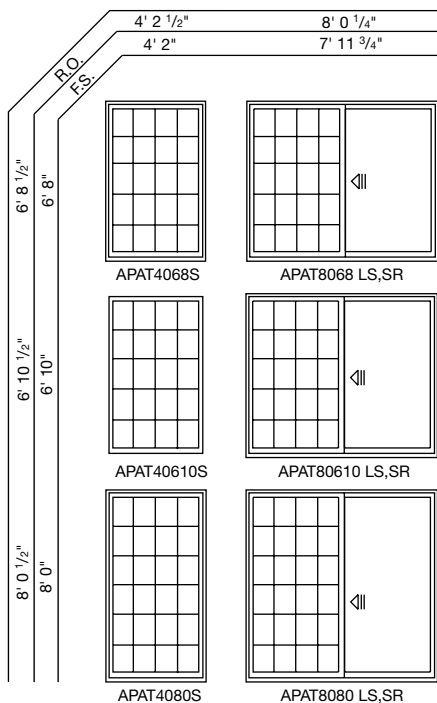

**4-Panel Gliding Patio Door Sizes**

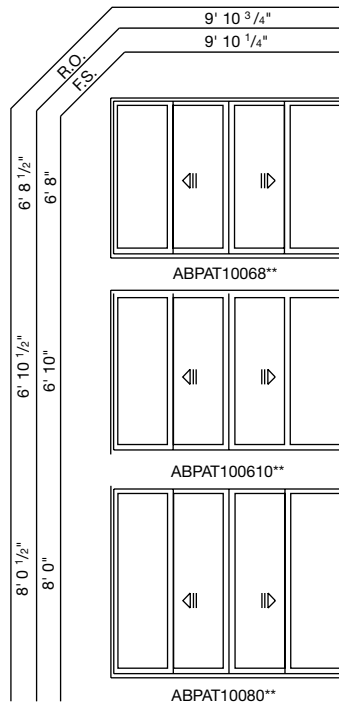

# GLIDING PATIO DOORS

## 4-Panel Gliding Patio Door Sizes

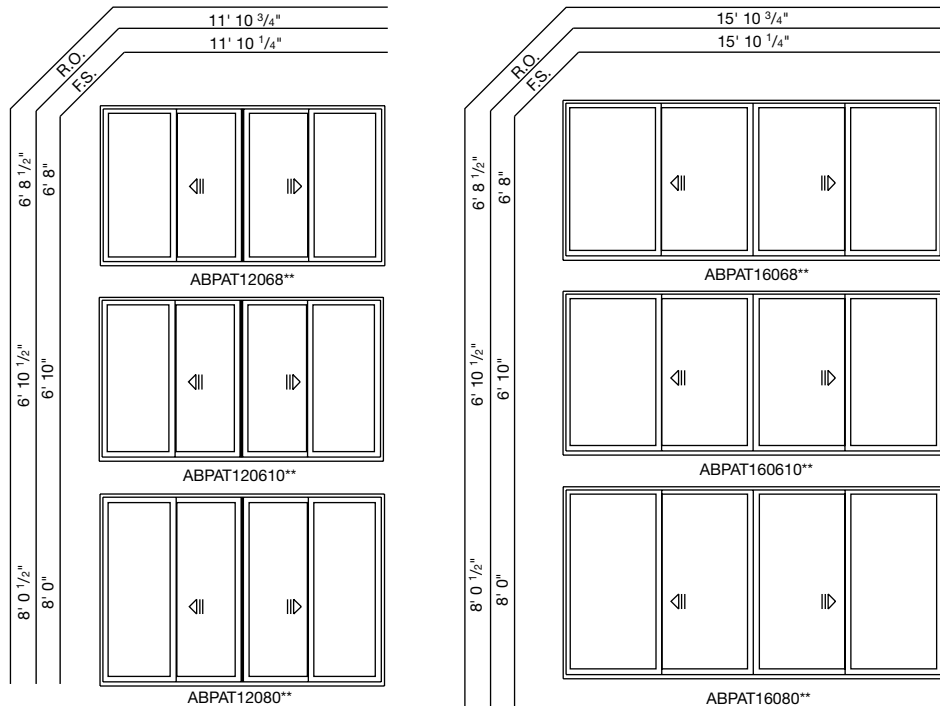

## Gliding Patio Door Direct-Set Elliptical Sizes (Specialty Frame)

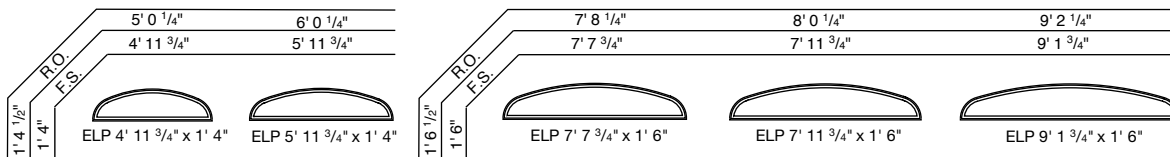

## Gliding Patio Door Direct-Set Transom Sizes (Specialty Frame)

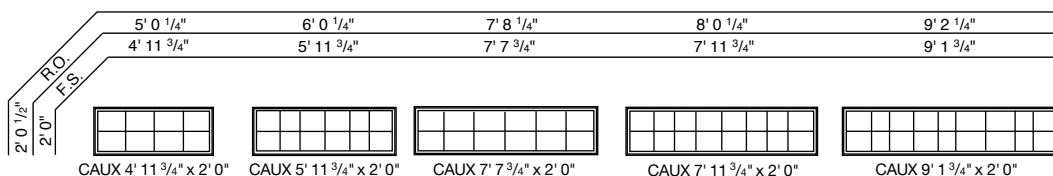

### NOTES

All doors and sidelights use safety/tempered glass.

If glass is positioned within 18" of the finished floor, safety/tempered glass may be required. Local codes may differ. Verify tempered glass requirements with your local building code official.

Astragal is applied to third panel from the left (as viewed from the exterior) on a 4-panel gliding patio door.

\*\*4-panel doors are shipped knocked down and require field assembly because of size and weight.

See transom notes on page 149.

Use structural joining material when necessary or required by code.

The light patterns illustrated apply to removable interior wood grilles, Full Divided Light, Simulated Divided Light, Decorelle 100, 150 and 400 and Finelight™ Grilles-Between-the-Glass. All removable interior wood grilles will be installed in the units unless otherwise specified. The staggered light patterns illustrated align with light patterns for the gliding door. Other light patterns are available upon request.

For a metric conversion in millimeters, multiply dimensions in inches by 25.4.

### FORMULA FOR COMBINATION DOORS

The overall frame dimension (both width and height) is equal to the sum of the individual unit frame dimensions plus joining material dimension(s).

The overall rough opening (both width and height) is equal to the overall frame dimensions plus 1/4" on all sides.

**FOR WINDOWS GREATER THAN 30 SQUARE FEET OR RATED HIGHER THAN PG50, ONE OF THESE THREE INSTALLATION METHODS IS REQUIRED:  
A) THROUGH THE JAMB B) ALUMINUM INSTALLATION FLANGE OR C) INSTALLATION CLIPS.  
ADDITIONAL CUSTOM SIZES ARE AVAILABLE. CONTACT YOUR LOCAL SUPPLIER FOR MORE INFORMATION. DRAWINGS ARE NOT TO SCALE.**

**Gliding Patio Door Direct-Set Half Circle Sizes (Specialty Frame)**

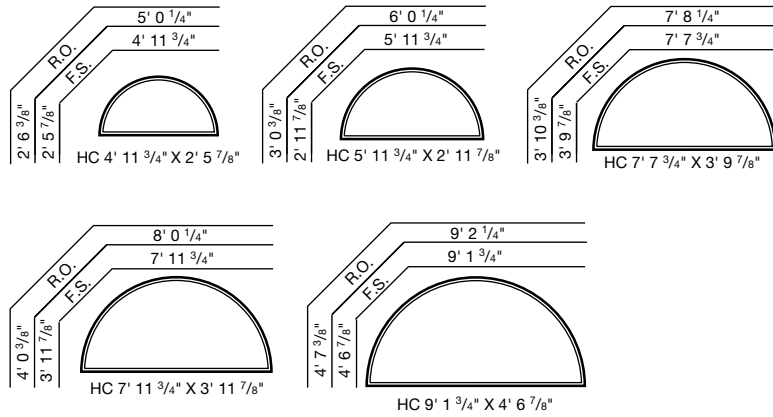

**NOTES**

4' 11-3/4" wide units are used above 5068, 50610 or 5080 Gliding Patio Doors.

5' 11-3/4" wide units are used above 6068, 60610 or 6080 Gliding Patio Doors.

7' 7-3/4" wide units are used above 7668, 76610 or 7680 Gliding Patio Doors.

7' 11-3/4" wide units are used above 8068, 80610 or 8080 Gliding Patio Doors.

9' 1-3/4" wide units are used above 9068, 90610 or 9080 Gliding Patio Doors.

See notes on page 148 for more information.

**Gliding Patio Doors**

**Astragal**

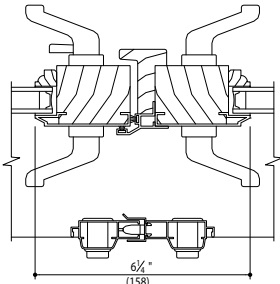

Contemporary door panel shown with ovolo (colonial) glass stops.

Dimensions in parentheses are in millimeters.

**Gliding Patio Door**

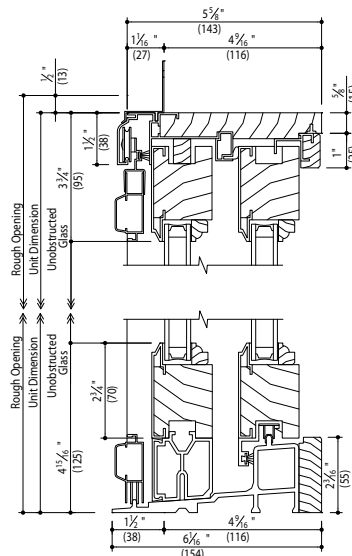

Vertical Section

**Gliding Patio Door Sidelight**

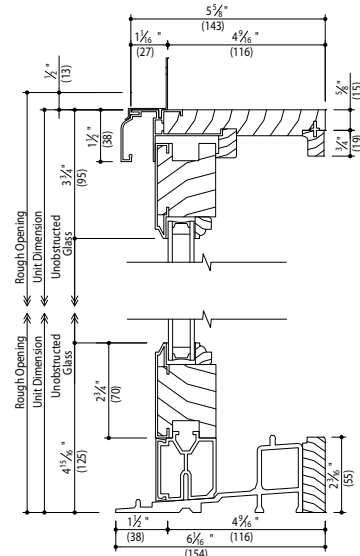

Vertical Section

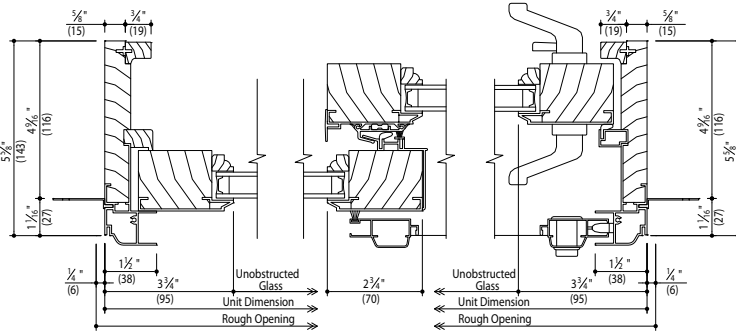

Horizontal Section

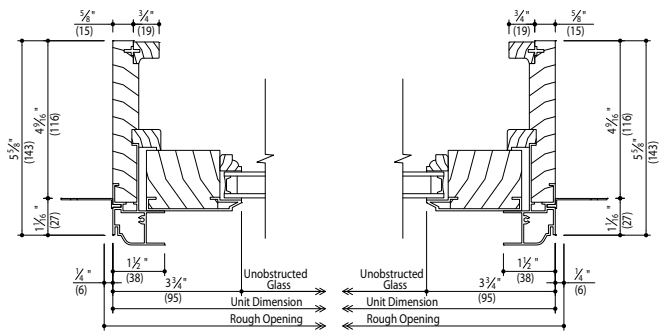

Horizontal Section

**FOR WINDOWS GREATER THAN 30 SQUARE FEET OR RATED HIGHER THAN PG50, ONE OF THESE THREE INSTALLATION METHODS IS REQUIRED:**  
**A) THROUGH THE JAMB B) ALUMINUM INSTALLATION FLANGE OR C) INSTALLATION CLIPS.**  
**ADDITIONAL PROPER INSTALLATION AND MAINTENANCE OF E-SERIES PRODUCTS IS ESSENTIAL TO ATTAIN OPTIMUM PERFORMANCE AND OPERATION.**  
**WRITTEN INSTALLATION INSTRUCTIONS THAT PROVIDE GUIDELINES FOR PROPER INSTALLATION ARE AVAILABLE BY VISITING ANDERSENWINDOWS.COM.**  
**CUSTOM SIZES ARE AVAILABLE. CONTACT YOUR LOCAL SUPPLIER FOR MORE INFORMATION. DRAWINGS ARE NOT TO SCALE.**

# GLIDING PATIO DOORS

## French Gliding Patio Door Sizes

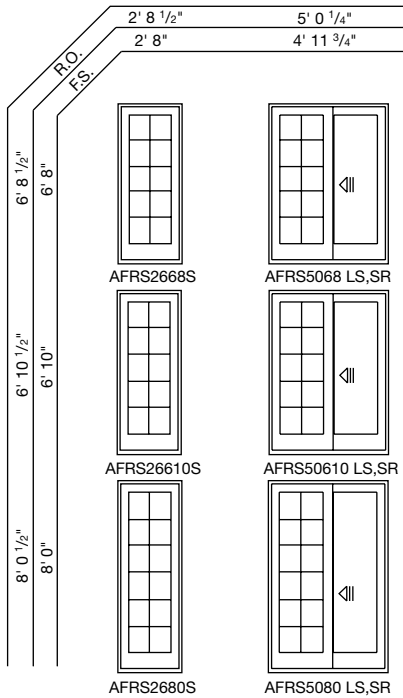

### NOTES

All doors and sidelights use safety/tempered glass.

Use structural joining material when necessary or required by code.

The light patterns illustrated apply to removable interior wood grilles, Full Divided Light, Simulated Divided Light, Decorelle 100, 150 and 400 and Finelight™ Grilles-Between-the-Glass. All removable interior wood grilles will be installed in the units unless otherwise specified.

For a metric conversion in millimeters, multiply dimensions in inches by 25.4.

### FORMULA FOR COMBINATION DOORS

The overall frame dimension (both width and height) is equal to the sum of the individual unit frame dimensions plus joining material dimension(s).

The overall rough opening (both width and height) is equal to the overall frame dimensions plus 1/4" on all sides.

## French Gliding Patio Door Sizes

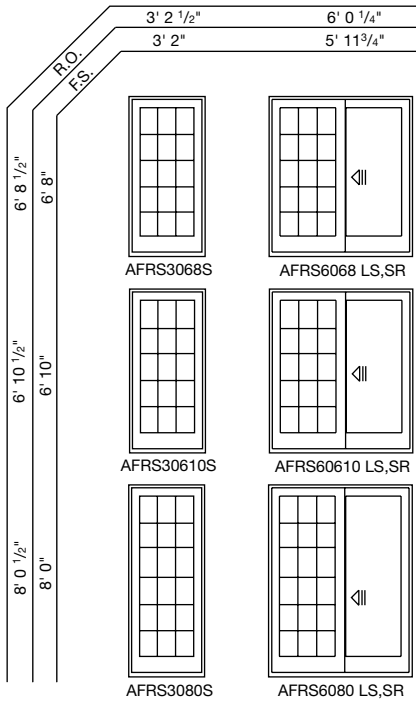



**French Gliding Patio Door Sizes**

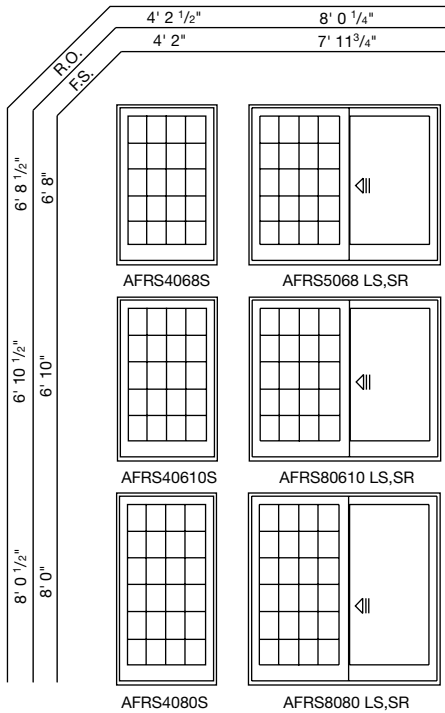

**4-Panel French Gliding Patio Door Sizes**

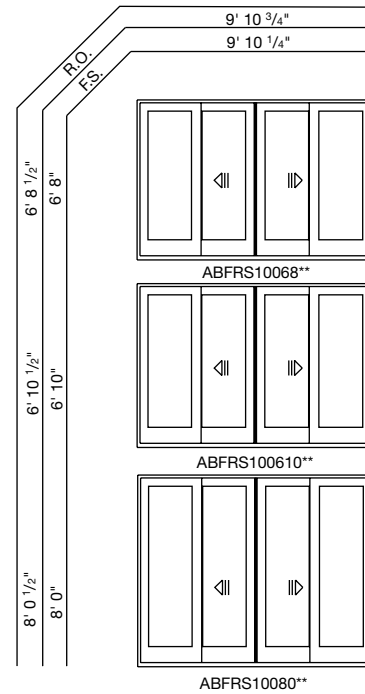

**4-Panel French Gliding Patio Door Sizes**

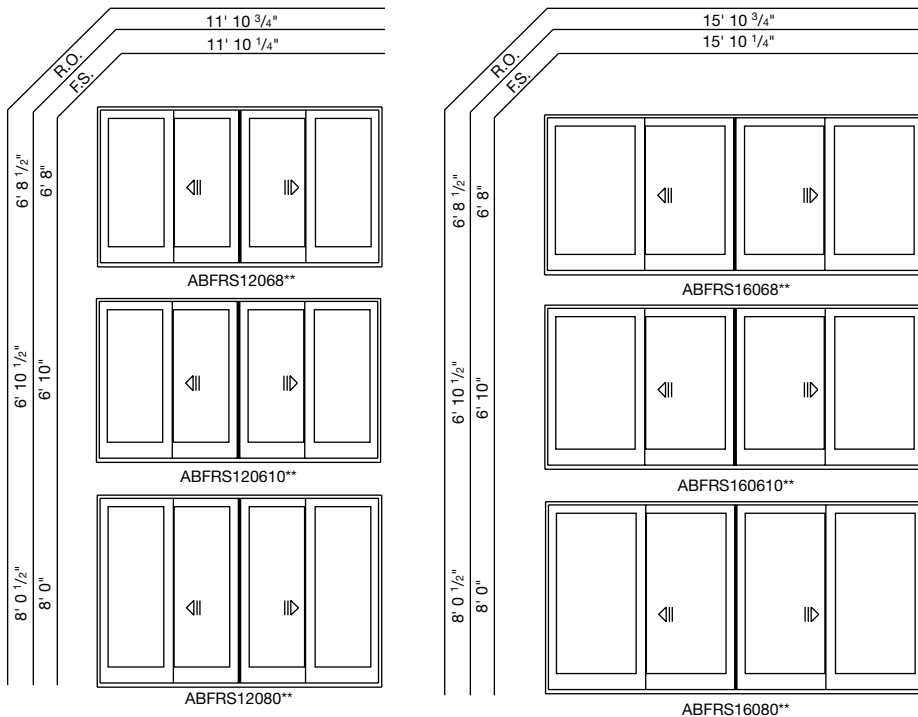

**NOTES**

All doors and sidelights use safety/tempered glass.

Astragal is applied to third panel from the left (as viewed from the exterior) on a 4-panel French gliding patio door.

\*\* 4-panel doors are shipped knocked down and require field assembly because of size and weight.

See notes on page 150 for more information.

# GLIDING PATIO DOORS

## French Gliding Patio Door Direct-Set Transom Sizes (Specialty Frame)

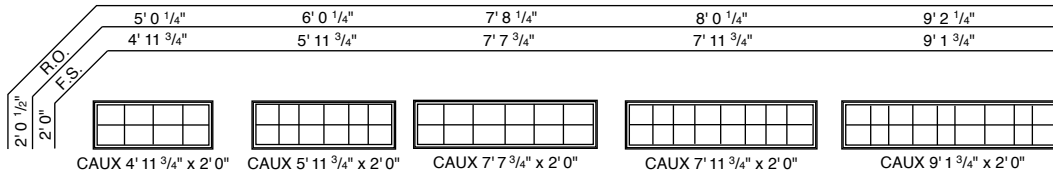

## French Gliding Patio Door Direct-Set Elliptical Sizes (Specialty Frame)

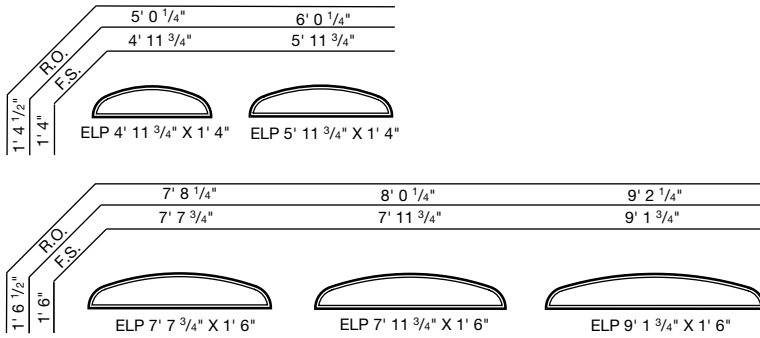

## French Gliding Patio Door Direct-Set Half Circle Sizes (Specialty Frame)

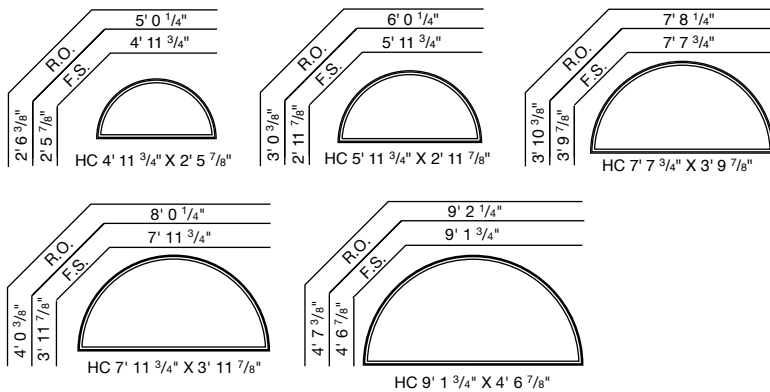

### NOTES

All doors and sidelights use safety/tempered glass.

If glass is positioned within 18" of the finished floor, safety/tempered glass may be required. Local codes may differ. Verify tempered glass requirements with your local building code official.

4' 11-3/4" wide units are used above 5068, 50610 or 5080 French Gliding Patio Doors.

5' 11-3/4" wide units are used above 6068, 60610 or 6080 French Gliding Patio Doors.

7' 7-3/4" wide units are used above 7668, 76610 or 7680 French Gliding Patio Doors.

7' 11-3/4" wide units are used above 8068, 80610 or 8080 French Gliding Patio Doors.

9' 1-3/4" wide units are used above 9068, 90610 or 9080 French Gliding Patio Doors.

Use structural joining material when necessary or required by code.

The light patterns illustrated apply to removable interior wood grilles, Full Divided Light, Simulated Divided Light, Decorelle 100, 150 and 400 and Finelight™ Grilles-Between-the-Glass. All removable interior wood grilles will be installed in the units unless otherwise specified. The staggered light patterns illustrated align with light patterns in the gliding door. Other light patterns are available upon request.

For a metric conversion in millimeters, multiply dimensions in inches by 25.4.

### FORMULA FOR COMBINATION DOORS

The overall frame dimension (both width and height) is equal to the sum of the individual unit frame dimensions plus joining material dimension(s).

The overall rough opening (both width and height) is equal to the overall frame dimensions plus 1/4" on all sides.

**FOR WINDOWS GREATER THAN 30 SQUARE FEET OR RATED HIGHER THAN PG50, ONE OF THESE THREE INSTALLATION METHODS IS REQUIRED:  
A) THROUGH THE JAMB B) ALUMINUM INSTALLATION FLANGE OR C) INSTALLATION CLIPS.  
ADDITIONAL CUSTOM SIZES ARE AVAILABLE. CONTACT YOUR LOCAL SUPPLIER FOR MORE INFORMATION. DRAWINGS ARE NOT TO SCALE.**

**French Gliding Patio Doors**

**French Gliding Patio Door**

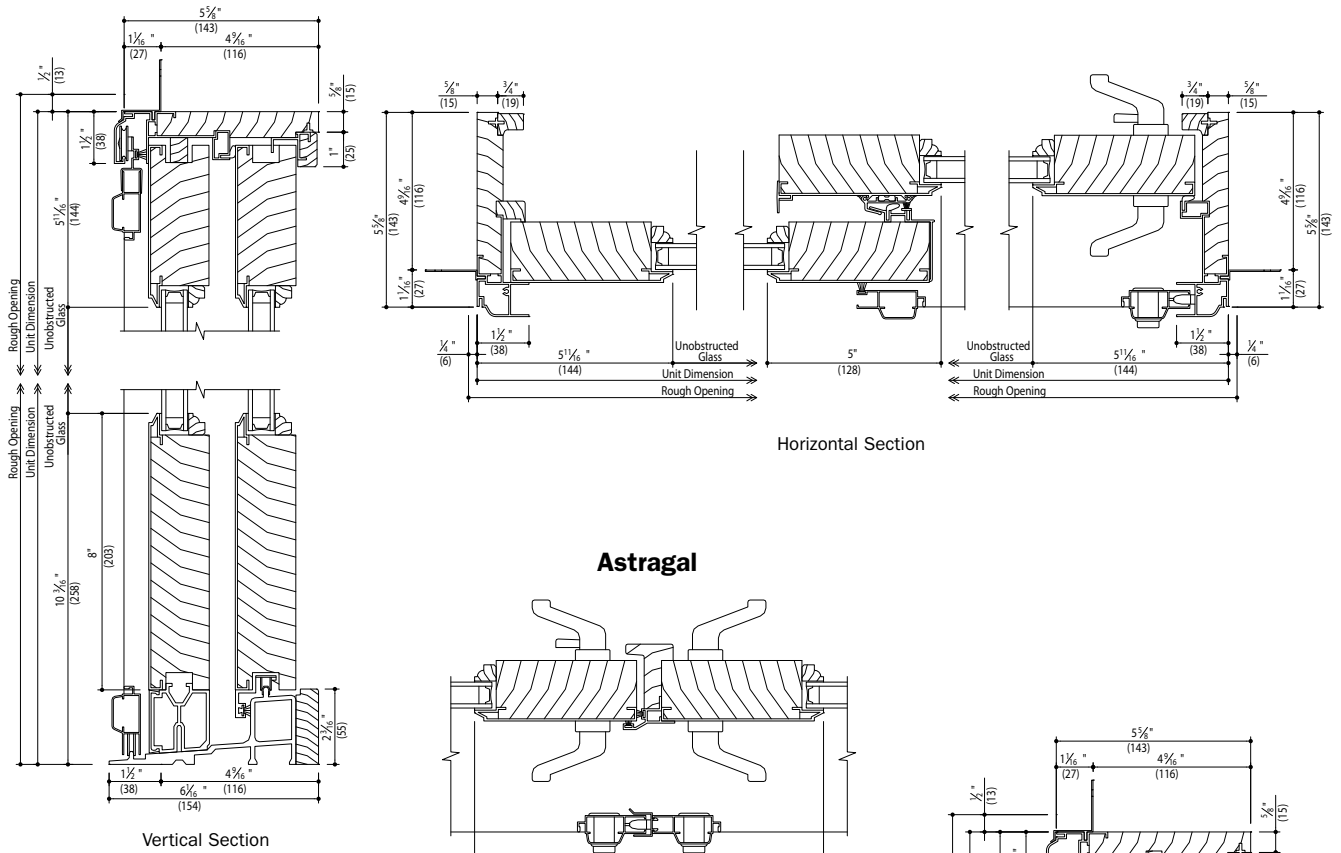

Horizontal Section

**Astragal**

Vertical Section

Shown with ovolo (colonial) glass stops.  
Door panel with 8" bottom rail shown, also available with 12" bottom rail.  
Dimensions in parentheses are in millimeters.

**French Gliding Patio Door Sidelight**

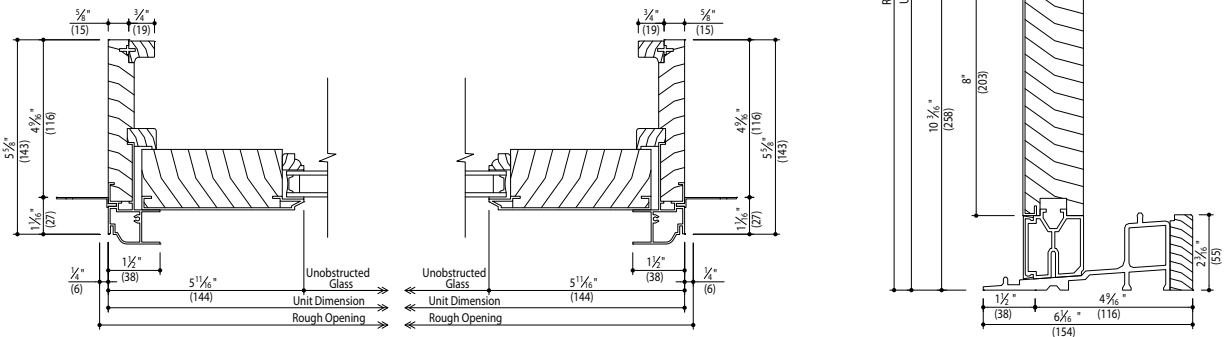

Horizontal Section

Vertical Section

**PROPER INSTALLATION AND MAINTENANCE OF E-SERIES PRODUCTS IS ESSENTIAL TO ATTAIN OPTIMUM PERFORMANCE AND OPERATION. WRITTEN INSTALLATION INSTRUCTIONS THAT PROVIDE GUIDELINES FOR PROPER INSTALLATION ARE AVAILABLE BY VISITING ANDERSENWINDOWS.COM. CUSTOM SIZES ARE AVAILABLE. CONTACT YOUR LOCAL SUPPLIER FOR MORE INFORMATION. DRAWINGS ARE NOT TO SCALE.**

# Installation Materials

We offer a variety of accessory metals to ensure a coordinated, low-maintenance window or door system. Available in 50 exterior colors at no additional cost, these trims save time on the job site.

## Joining Components

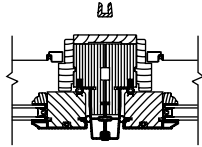

Standard Exterior Mull Cover

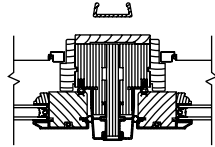

1/2" Exterior Mull Cover

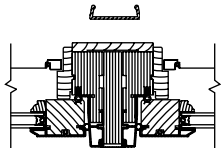

3/4" Exterior Mull Cover

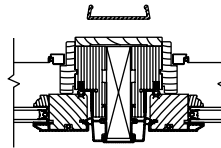

1" Exterior Mull Cover

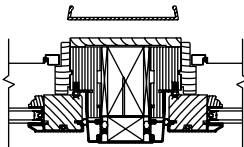

2" Exterior Mull Cover

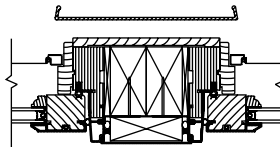

3-1/2" Exterior Mull Cover

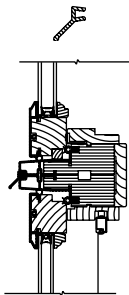

Standard Exterior Mull Cover with Drip

## Bay and Bow Trim Metals & Applications

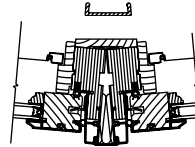

10° Casement Bow Exterior Mull Cover

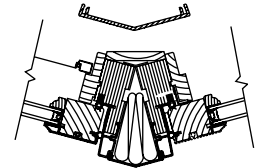

30° Casement Angle Bay Exterior Mull Cover

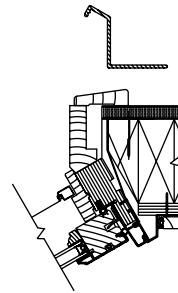

30° Angle Bay Enclosure

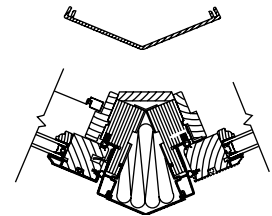

45° Casement Angle Bay Exterior Mull Cover

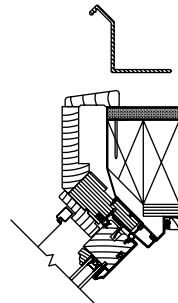

45° Angle Bay Enclosure



30° Angle Bay Exterior Mull Cover



45° Double-Hung Exterior Mull Cover

**Trim Metals & Applications**

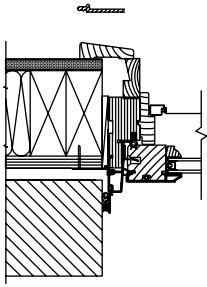

3/4" Frame Extender

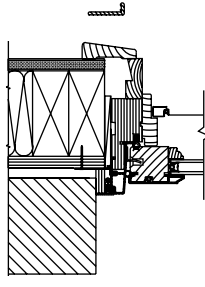

3/4" Frame Expander

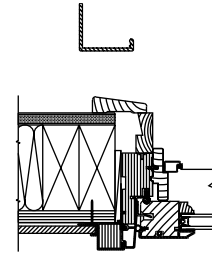

90° Angle Expander

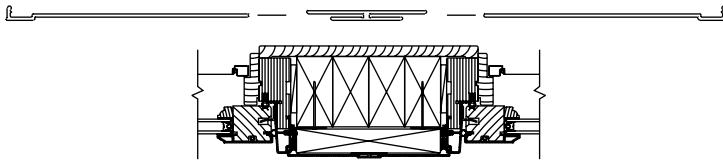

1-1/2" Mull Expander – May be used with adjustable mull covers or frame expanders (vertical joins only)

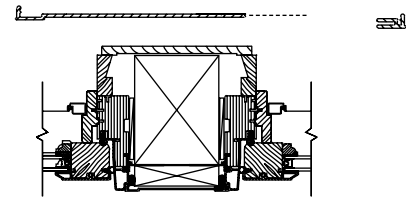

1" - 5" Adjustable Mull Cover and Receiver (vertical join)

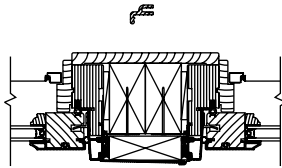

Frame Expander Receiver

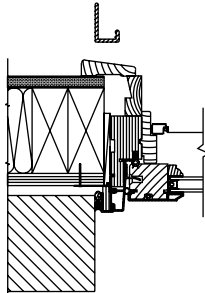

Expander Return

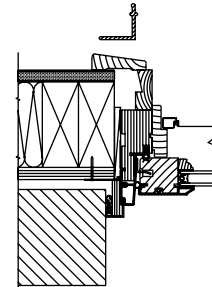

3/4" Frame Enclosure

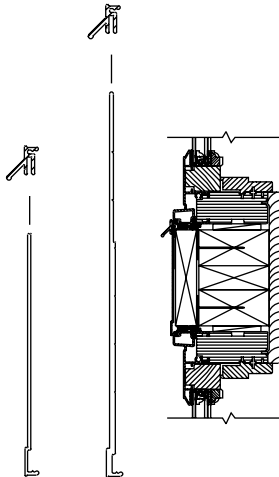

1" - 5" and 5-1/4" - 8" Adjustable Mull Cover and Receiver with Drip Leg (horizontal join)

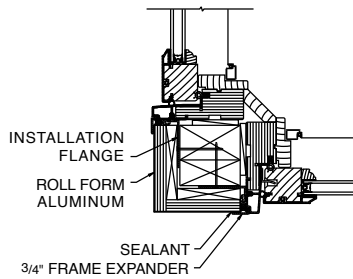

Corner Post Section of Box Bay Using Roll Form Metal on Corners

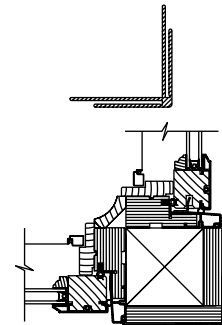

90° Outside Corner



2-1/4" Frame Expander

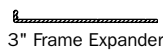

3" Frame Expander

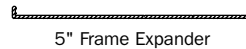

5" Frame Expander

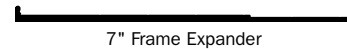

7" Frame Expander

PROPER INSTALLATION AND MAINTENANCE OF E-SERIES PRODUCTS IS ESSENTIAL TO ATTAIN OPTIMUM PERFORMANCE AND OPERATION. WRITTEN INSTALLATION INSTRUCTIONS THAT PROVIDE GUIDELINES FOR PROPER INSTALLATION ARE AVAILABLE BY VISITING [ANDERSENWINDOWS.COM](http://ANDERSENWINDOWS.COM).

## Applications

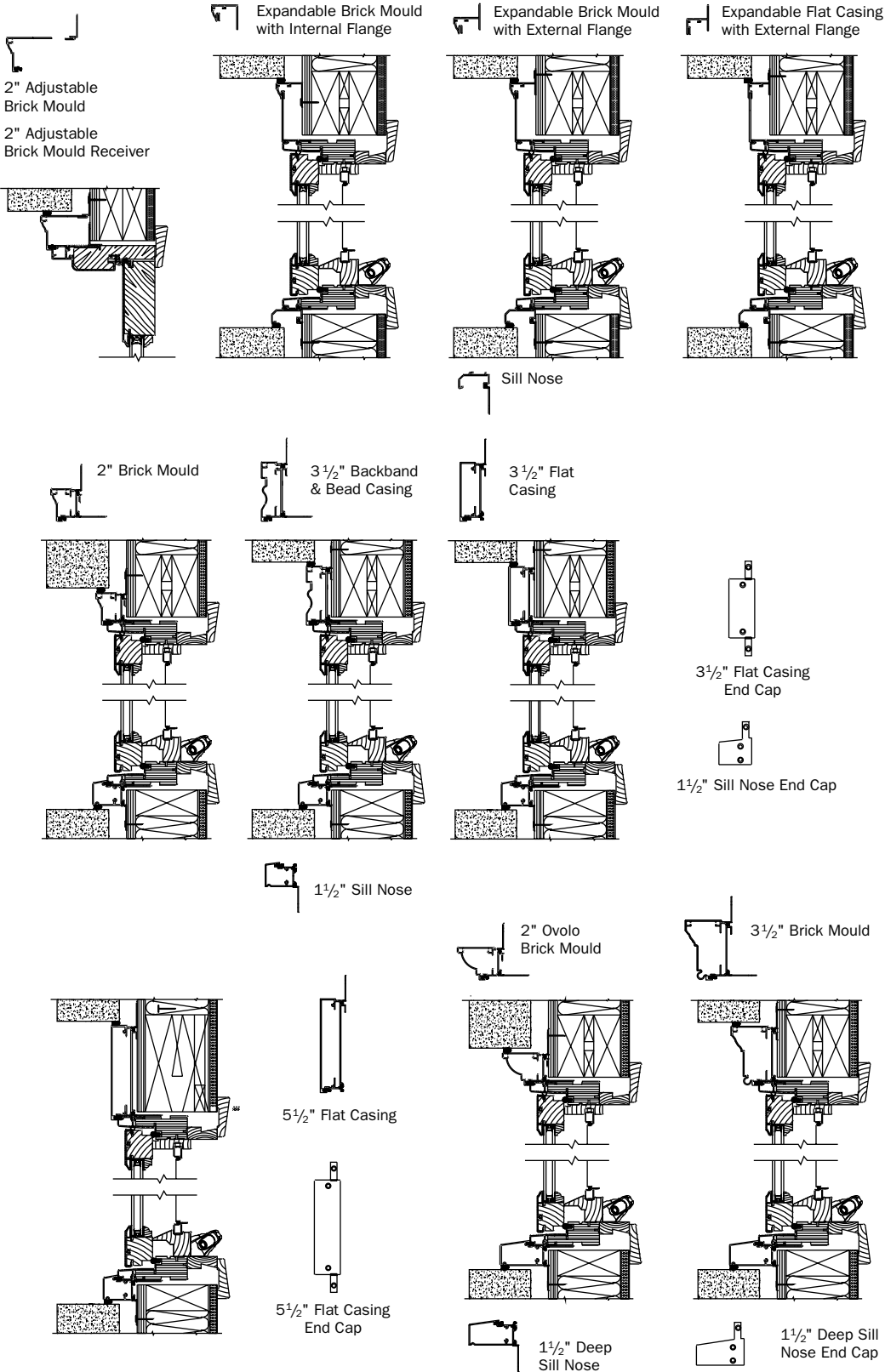

## Drip Caps & Applications

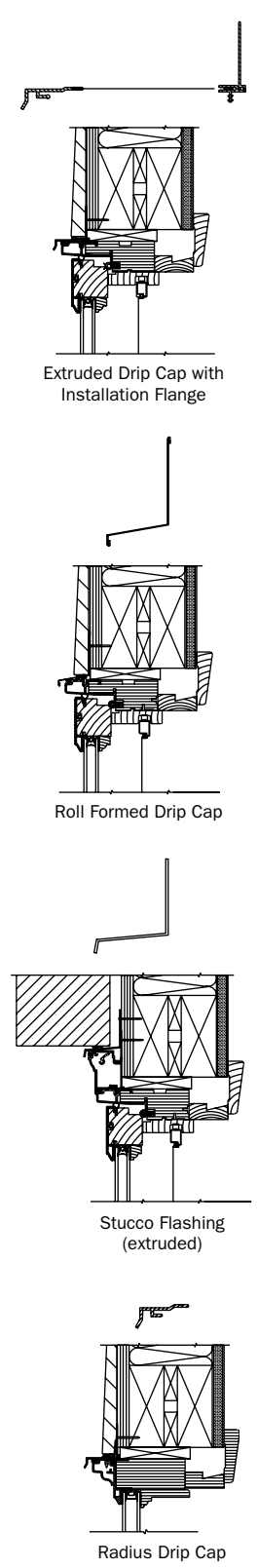

PROPER INSTALLATION AND MAINTENANCE OF E-SERIES PRODUCTS IS ESSENTIAL TO ATTAIN OPTIMUM PERFORMANCE AND OPERATION. WRITTEN INSTALLATION INSTRUCTIONS THAT PROVIDE GUIDELINES FOR PROPER INSTALLATION ARE AVAILABLE BY VISITING [ANDERSENWINDOWS.COM](http://ANDERSENWINDOWS.COM).

**Miscellaneous Trim Metals & Applications**

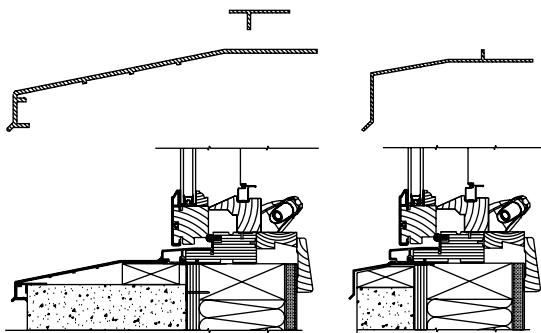

Extruded Sub-sill and T Sub-sill Clip

Alternate T Sub-sill

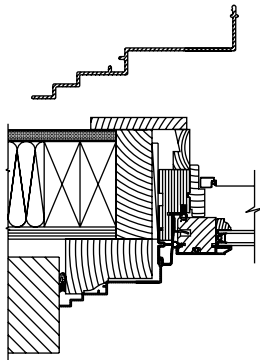

Historical Panning

**Sub-Frame Shell System**

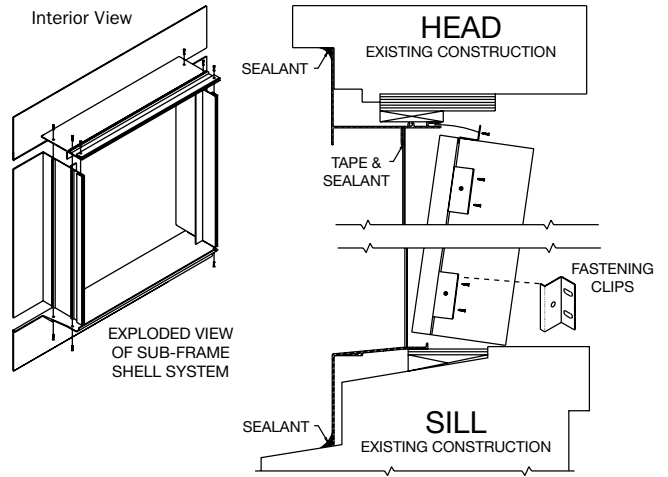

The E-Series Sub-Frame Shell System is a simple and effective way to meet remodeling needs for residential and commercial projects. Preserving existing buildings and neighborhoods has become increasingly important to our society. And a good, sound, older structure can be as efficient as, if not more efficient than, a new building.

Many E-Series products will work in the Sub-Frame Shell System for remodeling, which means you have unlimited design choices to fit the existing architecture. The Sub-Frame Shell System is a heavy aluminum perimeter-flange sub-frame that covers most existing construction conditions. It can be installed from the inside without costly scaffolding or off-staging.

**Masonry Opening Formulas**

Masonry Opening Formulas			
Formulas allow 1/4" for backer rod and sealant around entire perimeter			
2" Brick Mould 2" Ovolo Brick Mould	WIDTH		Frame + 3 3/4"
	HEIGHT	w/ Sill Nose	Frame + 3 1/4"
		4-Sides	Frame + 3 3/4"
	3-Sides	Frame + 2 1/8"	
3 1/2" Flat Casing 3 1/2" Brick Mould 3 1/2" Backband & Bead Casing	WIDTH		Frame + 6 3/4"
	HEIGHT	w/ Sill Nose	Frame + 4 3/4"
		4-Sides	Frame + 6 3/4"
	3-Sides	Frame + 3 5/8"	
5 1/2" Flat Casing	WIDTH		Frame + 10 3/4"
	HEIGHT	w/ Sill Nose	Frame + 6 3/4"
		4-Sides	Frame + 10 3/4"
	3-Sides	Frame + 5 5/8"	

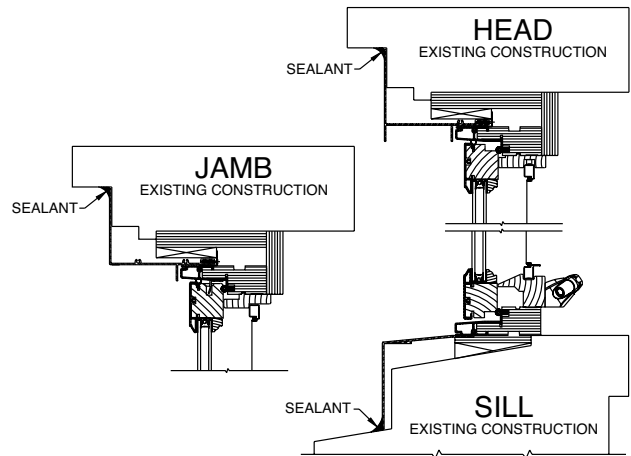

# PRODUCT PERFORMANCE

## Performance Grade & Air Infiltration Ratings for E-Series Windows & Patio Doors – Dual-Pane & Triple-Pane Glass

For current performance information, please visit [andersenwindows.com](http://andersenwindows.com).

Andersen® Product	Panel Type	AAMA/WDMA/CSA 101/I.S.2/A440 Performance Grade (PG)	+/- Corresponding Design Pressure (DP)	Air Infiltration CFM/FT <sup>2</sup>
<b>Casement Windows</b>				
Stationary (6060)	-	Class CW-PG50-FW Size Tested 72" x 72"	50/50	≤0.2
Venting (2660)	-	Class CW-PG55-C Size Tested 30" x 72" *	55/55	≤0.2
Venting (3028)	-	Class CW-PG55-C Size Tested 36" x 32"	55/55	≤0.2
Venting (3056)	-	Class CW-PG60-C Size Tested 36" x 66"	60/60	≤0.2
Venting, piano hinge (3060)	-	Class CW-PG70-C Size Tested 36" x 72"	70/70	≤0.2
<b>Awning Windows</b>				
Venting (4030)	-	Class LC-PG50-AP Size Tested 48" x 36"	50/50	≤0.2
Venting (4050)	-	Class LC-PG50-AP Size Tested 48" x 60"	50/50	≤0.2
Venting (4056)	-	Class LC-PG65-AP Size Tested 48" x 66"	65/65	≤0.2
<b>Casement &amp; Awning Picture/Transom Windows</b>				
Fixed (46100) <i>dual-pane glass only</i>	-	Class CW-PG80-FW Size Tested 54" x 120" *	80/80	≤0.2
Fixed (6080) <i>dual-pane glass only</i>	-	Class CW-PG80-FW Size Tested 72" x 96"	80/80	≤0.2
<b>Arch Casement Windows</b>				
Stationary (6060)	-	Class LC-PG50-FW Size Tested 72" x 72"	50/50	≤0.2
Venting (3028)	-	Class CW-PG55-C Size Tested 36" x 32" *	55/55	≤0.2
Venting (3056)	-	Class CW-PG60-C Size Tested 36" x 66"	60/60	≤0.2
Venting (3060)	-	Class CW-PG70-C Size Tested 36" x 72"	70/70	≤0.2
<b>French Casement Windows</b>				
Venting (5050) <i>dual-pane glass only</i>	-	Class LC-PG30-C Tested 60" x 60"	30/30	≤0.2
<b>Push Out Casement Windows</b>				
Venting (3034)	-	Class LC-PG50-C Size Tested 36" x 40"	50/50	≤0.2
Venting (3060)	-	Class LC-PG50-C Size Tested 36" x 72"	50/50	≤0.2
<b>Push Out Awning Windows</b>				
Venting (3440)	-	Class LC-PG40-AP Size Tested 40" x 48"	40/40	≤0.2
Venting (4040)	-	Class LC-PG40-AP Size Tested 48" x 48"	40/40	≤0.2
<b>Double-Hung Full-Frame Windows</b>				
Venting (3470)	-	Class LC-PG55-H Size Tested 40" x 84"	55/55	≤0.2
Venting (3866)	-	Class LC-PG55-H Size Tested 44" x 78"	55/55	≤0.2
Venting (4060)	-	Class LC-PG55-H Size Tested 48" x 72"	55/55	≤0.2
Venting (4686)	-	Class LC-PG30-H Size Tested 54" x 102"	30/30	≤0.2
<b>Double-Hung Picture Full-Frame Windows</b>				
Fixed (5066)	-	Class CW-PG55-FW Size Tested 60" x 78"	55/55	≤0.2
<b>Double-Hung Transom Full-Frame Windows</b>				
Fixed (4040)	-	Class R-PG55-FW Size Tested 48" x 48"	55/55	≤0.2
<b>Double-Hung Insert Windows</b>				
Venting (3866)	-	Class LC-PG30-H Size Tested 44" x 78"	30/30	≤0.2
<b>Double-Hung Picture Insert Windows</b>				
Fixed (5066)	-	Class CW-PG30-FW Size Tested 60" x 78"	30/30	≤0.2
<b>Monumental Single-Hung Windows</b>				
Venting (40100)	-	Class LC-PG35-H Size Tested 48" x 120"	35/35	≤0.2
Venting (5090)	-	Class LC-PG30-H Size Tested 60" x 108"	30/30	≤0.2

\* "Performance Grade (PG)" ratings may vary from tested performance rating for larger or smaller units of a particular type.

*continued on next page*

\* This data is accurate as of October 2018. Due to ongoing product changes, updated test results or new industry standards, this data may change over time.

\* Where designated, Andersen products are certified and labeled to the requirements of the Hallmark Certification Program. Actual performance may vary based on variations in manufacturing, shipping, installation, environmental conditions and conditions of use.

\* Contact your Andersen supplier for more information.

\* Test specimen size is smaller than the North American Fenestration Standard (NAFS) gateway size specified for this product type and performance class.



**Performance Grade & Air Infiltration Ratings for E-Series Windows & Patio Doors – Dual-Pane & Triple-Pane Glass** *(continued)*

 For current performance information, please visit [andersenwindows.com](http://andersenwindows.com).

Andersen® Product	Panel Type	AAMA/WDMA/CSA 101/I.S.2/A440 Performance Grade (PG)	+/- Corresponding Design Pressure (DP)	Air Infiltration CFM/FT <sup>2</sup>
<b>Gliding Windows</b>				
Venting, active-stationary (6040)	-	Class CW-PG30-HS Size Tested 72" x 48"	30/30	≤0.2
Venting, active-stationary (6050)	-	Class CW-PG30-HS Size Tested 72" x 60"	30/30	≤0.2
<b>Specialty Windows</b>				
Fixed, rectangle (46120)	-	Class CW-PG55-FW Size Tested 54" x 144" *	55/55	≤0.2
Fixed, rectangle (5080)	-	Class CW-PG75-FW Size Tested 60" x 96"	75/75	≤0.2
<b>Gliding &amp; French Gliding Patio Doors</b>				
Single, stationary (4080)	Contemporary panel with 2 3/4" stiles & rails <sup>1</sup>	Class LC-PG50-SLT Size Tested 50" x 96"	50/50	≤0.2
Two-panel (6080)	Contemporary panels with 4 11/16" stiles & rails <sup>2</sup>	Class LC-PG50-SD Size Tested 71" x 96"	50/50	≤0.2
Two-panel (8080)	Contemporary panels with 4 11/16" stiles & rails <sup>2</sup>	Class LC-PG40-SD Size Tested 95" x 96"	40/40	≤0.2
Two-panel (8080)	Contemporary panels with 2 3/4" stiles & rails	Class LC-PG30-SD Size Tested 95" x 96"	30/30	≤0.2
Four-panel (12080)	Contemporary panels with 4 11/16" stiles & rails <sup>2</sup>	Class LC-PG40-SD Size Tested 142" x 96"	40/40	≤0.2
Four-panel (16080)	Contemporary panels with 2 3/4" stiles & rails <sup>3</sup>	Class LC-PG25-SD Size Tested 190" x 96"	25/25	≤0.2
<b>Hinged Inswing Patio Doors &amp; Sidelights</b>				
Single, stationary or sidelight (34100)	French panel with 2 3/4" stiles, 4 11/16" top rail & 8" bottom rail <sup>4</sup>	Class LC-PG45-FD Size Tested 40" x 119.5"	45/60	≤0.2
Single, stationary (34100)	Contemporary panel with 3 11/16" stiles & rails <sup>5</sup>	Class LC-PG45-FD Size Tested 40.5" x 120"	45/50	≤0.2
Single, active (3486)	Contemporary panel with 4 11/16" stiles & rails <sup>6</sup>	Class LC-PG45-SHD Size Tested 40" x 102"	45/65	≤0.2
Single, active (3486)	Contemporary panel with 3 11/16" stiles & rails	Class LC-PG45-SHD Size Tested 40.5" x 102"	45/50	≤0.2
Single, active, low threshold sill ** (3486)	Contemporary panel with 3 11/16" stiles & rails <sup>5</sup>	Class LC-PG50-LW SHD Size Tested 40.5" x 101.18"	50/50	≤0.2
Single, active, low threshold sill ** (3486)	French panel with 4 11/16" stiles, 4 11/16" top rail & 8" bottom rail <sup>7</sup>	Class LC-PG50-LW SHD Size Tested 40" x 101"	50/60	≤0.2
Single, active (34100)	French panel with 4 11/16" stiles, 4 11/16" top rail & 8" bottom rail <sup>8</sup>	Class LC-PG45-SHD Size Tested 40" x 119.5"	45/65	≤0.2
Single, active (34100)	Contemporary panel with 3 11/16" stiles & rails <sup>5</sup>	Class LC-PG45-SHD Size Tested 40.5" x 120"	45/50	≤0.2
Two-panel, stationary-stationary (6780)	French panels with 4 11/16" stiles, 4 11/16" top rail & 8" bottom rail <sup>7</sup>	Class LC-PG40-FD Size Tested 79" x 96"	40/40	≤0.2
Two-panel, stationary-stationary (6780)	Contemporary panels with 3 11/16" stiles & rails <sup>5</sup>	Class LC-PG40-FD Size Tested 79" x 95.3"	40/40	≤0.2
Two-panel, active-stationary, jamb hinged (6780)	Contemporary panels with 4 11/16" stiles & rails <sup>6</sup>	Class LC-PG45-SHD Size Tested 79" x 96"	45/45	≤0.2
Two-panel, active-stationary, jamb hinged (6780)	Contemporary panels with 3 11/16" stiles & rails	Class LC-PG45-SHD Size Tested 79" x 96"	45/45	≤0.2
Two-panel, active-stationary, astragal hinged (6780)	Contemporary panels with 4 11/16" stiles & rails <sup>6</sup>	Class LC-PG45-SHD Size Tested 79" x 96"	45/45	≤0.2
Two-panel, active-stationary, astragal hinged (6780)	Contemporary panels with 3 11/16" stiles & rails	Class LC-PG45-SHD Size Tested 79" x 96"	45/45	≤0.2
Two-panel, active-passive (6780)	Contemporary panels with 4 11/16" stiles & rails <sup>6</sup>	Class LC-PG40-SHD Size Tested 79" x 96"	40/40	≤0.2
Two-panel, active-passive, low threshold sill ** (6786)	Contemporary panels with 3 11/16" stiles & rails <sup>5</sup>	Class LC-PG30-LW SHD Size Tested 79" x 101"	30/30	≤0.2
Two-panel, active-passive (6786)	Contemporary panels with 4 11/16" stiles & rails <sup>9</sup>	Class LC-PG30-SHD Size Tested 79" x 102"	30/30	≤0.2
Two-panel, active-passive (6786)	Contemporary panels with 3 11/16" stiles & rails	Class LC-PG30-SHD Size Tested 79" x 101.8"	30/40	≤0.2
Two-panel, active-passive, low threshold sill ** (6786)	French panels with 4 11/16" stiles, 4 11/16" top rail & 8" bottom rail <sup>7</sup>	Class LC-PG30-LW SHD Size Tested 79" x 101"	30/30	≤0.2
Two-panel, active-passive (67100)	French panels with 4 11/16" stiles, 4 11/16" top rail & 8" bottom rail <sup>8</sup>	Class LC-PG35-SHD Size Tested 79" x 120"	35/35	≤0.2
Two-panel, active-passive (67100)	Contemporary panels with 3 11/16" stiles & rails <sup>5</sup>	Class LC-PG30-SHD Size Tested 79" x 120"	30/40	≤0.2

\*Performance Grade (PG) ratings may vary from tested performance rating for larger or smaller units of a particular type. *continued on next page*  
 \*This data is accurate as of October 2018. Due to ongoing product changes, updated test results or new industry standards, this data may change over time.  
 \*Where designated, Andersen products are certified and labeled to the requirements of the Hallmark Certification Program. Actual performance may vary based on variations in manufacturing, shipping, installation, environmental conditions and conditions of use.  
 \*Contact your Andersen supplier for more information.  
 \*Test specimen size is smaller than the North American Fenestration Standard (NAFS) gateway size specified for this product type and performance class.  
 \*\*Hinged doors with a low threshold sill have limited water performance.

**Numbered footnotes provide additional panel types for the same patio door, sidelight or transom listed above that are covered by the given test data. Commercial patio door panels, referenced as an additional panel type in the numbered footnotes below, do not include commercial doors with Concealed Panic System (CPS).**

- 1** Applies to similar contemporary door panel with 4 11/16" stiles & rails. Also applies to French door panel with 4 11/16" stiles, 4 11/16" top rail and 8" or 12" bottom rail.
- 2** Also applies to French door panels with 4 11/16" stiles, 4 11/16" top rail and 8" or 12" bottom rail.
- 3** Applies to similar contemporary door panels with 4 11/16" stiles & rails in doors with a unit dimension greater than 12' wide. Also applies to French door panels with 4 11/16" stiles, 4 11/16" top rail and 8" or 12" bottom rail in doors with a unit dimension greater than 12' wide.
- 4** Applies to similar French sidelight panel with 12" bottom rail; includes comparable commercial panel and similar non-commercial panel with intermediate rail and raised panel insert. Also applies to French door panel with 4 11/16" stiles, 4 11/16" top rail and 8" or 12" bottom rail; includes comparable commercial panel and similar non-commercial panel with intermediate rail and raised panel insert.
- 5** Also applies to contemporary door panel(s) with 4 11/16" stiles & rails.
- 6** Also applies to French door panel(s) with 4 11/16" stiles, 4 11/16" top rail and 8" or 12" bottom rail with or without intermediate rail and with or without raised panel insert; includes comparable commercial panel(s).
- 7** Applies to similar French door panel(s) with 12" bottom rail with or without intermediate rail and with or without raised panel insert; includes comparable commercial panel(s).
- 8** Applies to similar French door panel(s) with 12" bottom rail; includes comparable commercial panel(s).
- 9** Also applies to French door panels with 4 11/16" stiles, 4 11/16" top rail and 8" or 12" bottom rail; includes comparable commercial panels.

# PRODUCT PERFORMANCE

## Performance Grade & Air Infiltration Ratings for E-Series Windows & Patio Doors – Dual-Pane & Triple-Pane Glass *(continued)*

For current performance information, please visit [andersenwindows.com](http://andersenwindows.com).

Andersen® Product	Panel Type	AAMA/WDMA/CSA 101/I.S.2/A440 Performance Grade (PG)	+/- Corresponding Design Pressure (DP)	Air Infiltration CFM/FT <sup>2</sup>
<b>Hinged Inswing Patio Door Venting Sidelights</b>				
Sidelight, venting (2080)	French panel with 2 3/4" stiles, 4 11/16" top rail & 8" bottom rail <b>10</b>	Class CW-PG45-SLT Size Tested 24" x 96"	45/50	≤0.2
<b>Hinged Inswing Patio Door Transoms</b>				
Fixed (6720)	Panel with 2 3/4" stiles & rails <b>11</b>	Class CW-PG60-TR Size Tested 79" x 24"	60/60	≤0.2
<b>Arch Hinged Inswing Patio Doors &amp; Sidelights</b>				
Single, stationary or sidelight (3480)	French arch panel with 4 11/16" stiles, 4 11/16" top rail & 8" bottom rail <b>12</b>	Class CW-PG45-FD Size Tested 40" x 96"	45/60	≤0.2
Single, active (3480)	French arch panel with 4 11/16" stiles, 4 11/16" top rail & 8" bottom rail <b>13</b>	Class CW-PG45-SHD Size Tested 40" x 96"	45/55	≤0.2
Two-panel, active-passive (6080)	French unequal leg arch panels with 4 11/16" stiles, 4 11/16" top rail & 8" bottom rail <b>13</b>	Class LC-PG40-SHD Size Tested 72" x 96"	40/40	≤0.2
<b>Hinged Outswing Patio Doors &amp; Sidelights</b>				
Single, stationary or sidelight (2080)	French panel with 2 3/4" stiles, 4 11/16" top rail & 8" bottom rail, with intermediate rail at 35" location <b>10</b>	Class CW-PG80-SLT Size Tested 24.5" x 95.3"	80/80	≤0.2
Single, stationary or sidelight (21080)	French panel with 2 3/4" stiles, 4 11/16" top rail & 8" bottom rail, with intermediate rail at 35" location & raised panel insert <b>14</b>	Class CW-PG75-SLT Size Tested 34.6" x 95.3"	75/75	≤0.2
Single, stationary or sidelight (34100)	French panel with 2 3/4" stiles, 4 11/16" top rail & 8" bottom rail <b>15</b>	Class LC-PG75-SLT Size Tested 40" x 119.3"	75/80	≤0.2
Single, stationary (34100)	Contemporary panel with 3 11/16" stiles & rails <b>5</b>	Class LC-PG50-SLT Size Tested 40.5" x 120"	50/50	≤0.2
Single, active (3080)	French panel with 4 11/16" stiles, 4 11/16" top rail & 8" bottom rail, with intermediate rail at 35" location & raised panel insert	Class LC-PG60-SHD Size Tested 36.5" x 95.3"	60/60	≤0.2
Single, active (3080)	French panel with 2 3/4" stiles, 4 11/16" top rail & 8" bottom rail, with intermediate rail at 23 3/4" location & raised panel insert	Class LC-PG60-SHD Size Tested 36.5" x 95.3"	60/60	≤0.2
Single, active (3480)	French panel with 4 11/16" stiles, 4 11/16" top rail & 8" bottom rail <b>8</b>	Class LC-PG60 SHD Size Tested 40" x 95"	60/60	≤0.2
Single, active (3480)	French panel with 4 11/16" stiles, 4 11/16" top rail & 8" bottom rail, with intermediate rail at 35" location <b>16</b>	Class LC-PG60-SHD Size Tested 40" x 95.3"	60/60	≤0.2
Single, active, low threshold sill** (3480)	French panel with 4 11/16" stiles, 4 11/16" top rail & 8" bottom rail <b>7</b>	Class LC-PG60-LW SHD Size Tested 40" x 94"	60/60	≤0.2
Single, active, low threshold sill** (3480)	Contemporary panel with 3 11/16" stiles & rails <b>5</b>	Class LC-PG50-LW SHD Size Tested 40.5" x 94.8"	50/50	≤0.2
Single, active (3486)	Contemporary panel with 4 11/16" stiles & rails	Class LC-PG50-SHD Size Tested 40" x 101"	50/50	≤0.2
Single, active (3486)	Contemporary panel with 3 11/16" stiles & rails	Class LC-PG45-SHD Size Tested 40.5" x 101.5"	50/50	≤0.2
Single, active (34100)	French panel with 4 11/16" stiles, 4 11/16" top rail & 8" bottom rail <b>8</b>	Class LC-PG50-SHD Size Tested 40" x 119.3"	50/50	≤0.2
Single, active (34100)	Contemporary panel with 3 11/16" stiles & rails <b>5</b>	Class LC-PG45-SHD Size Tested 40.5" x 119.3"	50/50	≤0.2
Two-panel, stationary-stationary (6780)	French panels with 4 11/16" stiles, 4 11/16" top rail & 8" bottom rail <b>7</b>	Class LC-PG60-FD Size Tested 79" x 95.3"	60/60	≤0.2
Two-panel, stationary-stationary (6780)	Contemporary panels with 3 11/16" stiles & rails <b>5</b>	Class LC-PG50-FD Size Tested 79" x 96"	50/50	≤0.2

\*Performance Grade (PG) ratings may vary from tested performance rating for larger or smaller units of a particular type.

*continued on next page*

\*This data is accurate as of October 2018. Due to ongoing product changes, updated test results or new industry standards, this data may change over time.

\*Where designated, Andersen products are certified and labeled to the requirements of the Hallmark Certification Program. Actual performance may vary based on variations in manufacturing, shipping, installation, environmental conditions and conditions of use.

\*Contact your Andersen supplier for more information.

\*\*Hinged doors with a low threshold sill have limited water performance.

**Numbered footnotes provide additional panel types for the same patio door, sidelight or transom listed above that are covered by the given test data.**

**Commercial patio door panels, referenced as an additional panel type in the numbered footnotes below, do not include commercial doors with Concealed Panic System (CPS).**

**5** Also applies to contemporary door panel(s) with 4 11/16" stiles & rails.

**7** Applies to similar French door panel(s) with 12" bottom rail with or without intermediate rail and with or without raised panel insert; includes comparable commercial panel(s).

**8** Applies to similar French door panel(s) with 12" bottom rail; includes comparable commercial panel(s).

**10** Also applies to all available panels.

**11** Also applies to transom panel with 4 11/16" stiles and 2 3/4" rails and transom panel with 4 11/16" stiles and rails; includes all commercial transom panels.

**12** Applies to similar French door panel with 12" bottom rail; includes arch and unequal leg arch door panel with or without intermediate rail and with or without raised panel insert. Also applies to French sidelight panel with 8" or 12" bottom rail with or without intermediate rail and with or without raised panel insert.

**13** Also applies to all arch and unequal leg arch door panels with 4 11/16" stiles.

**14** Applies to similar French sidelight panel with intermediate rail at 23 3/4" location and raised panel insert. Also applies to French door panel with 4 11/16" stiles, 4 11/16" top rail and 8" or 12" bottom rail with intermediate rail with raised panel insert.

**15** Applies to similar French sidelight panel with 12" bottom rail; includes comparable commercial sidelight panel. Also applies to French door panel with 4 11/16" stiles, 4 11/16" top rail and 8" or 12" bottom rail; includes comparable commercial door panel.

**16** Applies to similar French door panel with intermediate rail at 23 3/4" location. Also applies to French door panel with 4 11/16" stiles, 4 11/16" top rail and 12" bottom rail and intermediate rail; includes comparable commercial door panel.

**Performance Grade & Air Infiltration Ratings for E-Series Windows & Patio Doors – Dual-Pane & Triple-Pane Glass** *(continued)*

 For current performance information, please visit [andersenwindows.com](http://andersenwindows.com).

Andersen® Product	Panel Type	AAMA/WDMA/CSA 101/I.S.2/A440 Performance Grade (PG)	+/- Corresponding Design Pressure (DP)	Air Infiltration CFM/FT <sup>2</sup>
<b>Hinged Outswing Patio Doors &amp; Sidelights</b>				
Two-panel, active-passive (6780)	French panels with 4 11/16" stiles, 4 11/16" top rail & 8" bottom rail <b>7</b>	Class LC-PG60-SHD Size Tested 79" x 95"	60/60	≤0.2
Two-panel, active-passive, low threshold sill ** (6780)	French panels with 4 11/16" stiles, 4 11/16" top rail & 8" bottom rail <b>17</b>	Class LC-PG50-LW SHD Size Tested 79" x 94"	50/50	≤0.2
Two-panel, active-passive, low threshold sill ** (6780)	Contemporary panels with 3 11/16" stiles & rails <b>5</b>	Class LC-PG40-LW SHD Size Tested 79" x 95"	40/40	≤0.2
Two-panel, active-passive (6786)	Contemporary panels with 4 11/16" stiles & rails	Class LC-PG40-SHD Size Tested 79" x 101"	40/40	≤0.2
Two-panel, active-passive (6786)	Contemporary panels with 3 11/16" stiles & rails	Class LC-PG45-SHD Size Tested 79" x 101.5"	45/45	≤0.2
Two-panel, active-passive (67100)	French panels with 4 11/16" stiles, 4 11/16" top rail & 8" bottom rail <b>8</b>	Class LC-PG40-SHD Size Tested 79" x 119"	40/40	≤0.2
Two-panel, active-passive (67100)	Contemporary panels with 3 11/16" stiles & rails <b>5</b>	Class LC-PG30-SHD Size Tested 79" x 120"	30/40	≤0.2
<b>Hinged Outswing Patio Door Venting Sidelights</b>				
Sidelight, venting (2080)	French panel with 2 3/4" stiles, 4 11/16" top rail & 8" bottom rail with intermediate rail at 35" location <b>10</b>	Class CW-PG50 Size Tested 24" x 96"	50/50	≤0.2
<b>Hinged Outswing Patio Door Transoms</b>				
Fixed (6720)	Panel with 2 3/4" stiles, top rail & bottom rail <b>10</b>	Class CW-PG80-TR Size Tested 79" x 24"	80/80	≤0.2
<b>Arch Hinged Outswing Patio Doors &amp; Sidelights</b>				
Single, stationary or sidelight (3480)	French arch panel with 4 11/16" stiles, 4 11/16" top rail & 8" bottom rail <b>12</b>	Class CW-PG80-FD Size Tested 40" x 96"	80/80	≤0.2
Single, active (3480)	French arch panel with 4 11/16" stiles, 4 11/16" top rail & 8" bottom rail <b>13</b>	Class LC-PG60-SHD Size Tested 40" x 96"	60/60	≤0.2
Two-panel (6080)	French unequal leg arch panels with 4 11/16" stiles, 4 11/16" top rail & 8" bottom rail <b>13</b>	Class LC-PG60-SHD Size Tested 79" x 96"	60/60	≤0.2

- \* "Performance Grade (PG)" ratings may vary from tested performance rating for larger or smaller units of a particular type.
- \* This data is accurate as of October 2018. Due to ongoing product changes, updated test results or new industry standards, this data may change over time.
- \* Where designated, Andersen products are certified and labeled to the requirements of the Hallmark Certification Program. Actual performance may vary based on variations in manufacturing, shipping, installation, environmental conditions and conditions of use.
- \* Contact your Andersen supplier for more information.
- \*\* Hinged doors with a low threshold sill have limited water performance.

**Numbered footnotes provide a list of additional panel types for the same patio door, sidelight or transom listed above that are covered by the given test data. Commercial patio door panels, referenced as an additional panel type in the numbered footnotes below, do not include commercial doors with Concealed Panic System (CPS).**

- 5** Also applies to contemporary door panel(s) with 4 11/16" stiles & rails.
- 7** Applies to similar French door panel(s) with 12" bottom rail with or without intermediate rail and with or without raised panel insert; includes comparable commercial panel(s).
- 8** Applies to similar French door panel(s) with 12" bottom rail; includes comparable commercial panel(s).
- 10** Also applies to all available panels.
- 12** Applies to similar French door panel with 12" bottom rail; includes arch and unequal leg arch door panel with or without intermediate rail and with or without raised panel insert. Also applies to French sidelight panel with 8" or 12" bottom rails with or without intermediate rail and with or without raised panel insert.
- 13** Also applies to all arch and unequal leg arch door panels with 4 11/16" stiles.
- 17** Applies to similar French door panel with 12" bottom rail; includes comparable commercial panel. Also applies to French door panel with 4 11/16" stiles, 4 11/16" top rail and 8" or 12" bottom rail with intermediate rail and raised panel insert.

 For performance ratings for E-Series products with Stormwatch® Protection, go to [andersenwindows.com](http://andersenwindows.com).

# PRODUCT PERFORMANCE

## Sound Transmission Ratings for E-Series Windows & Patio Doors

For current performance information, please visit [andersenwindows.com](http://andersenwindows.com).

Andersen® Product & Glass Type	Panel Type	Test Size	Sound Transmission Class (STC)	Outdoor/Indoor Transmission Class (OITC)
<b>Casement Windows - Stationary</b>				
Dual-Pane	-	48" x 60"	29	25
Dual-Panel Laminated, 0.030"			33	29
STC Upgrade			32	29
<b>Casement Windows - Venting</b>				
Dual-Pane	-	24" x 80"	29	25
Triple-Pane			30	24
Dual-Panel Laminated, 0.030"			33	29
STC Upgrade			33	28
<b>Double-Hung Windows</b>				
Dual-Pane	-	48" x 60"	28	24
Triple-Pane			28	24
Dual-Panel Laminated, 0.030"			33	29
STC Upgrade			32	27
<b>Double-Hung Picture Windows</b>				
Dual-Pane	-	48" x 60"	31	26
Dual-Panel Laminated, 0.030"			35	30
STC Upgrade			34	30
<b>Specialty Windows</b>				
Dual-Pane	-	48" x 60"	28	24
Dual-Panel Laminated, 0.030"			31	25
STC Upgrade			34	29
<b>French Gliding Patio Doors</b>				
Dual-Pane	French panels with 4 11/16" stiles, 4 11/16" top rail & 8" bottom rail	72" x 80"	29	24
Triple-Pane			30	25
Dual-Panel Laminated, 0.030"			32	29
STC Upgrade			30	28
<b>Hinged Inswing Patio Doors - Single Panel</b>				
Dual-Pane	French panel with 4 11/16" stiles, 4 11/16" top rail & 12" bottom rail	37.875" x 84"	31	26
Triple-Pane			31	27
Dual-Panel Laminated, 0.030"			33	30
STC Upgrade			33	30
<b>Hinged Inswing Patio Doors - Two-Panel</b>				
Dual-Pane	French panels with 4 11/16" stiles, 4 11/16" top rail & 12" bottom rail	74.812" x 84"	30	26
Triple-Pane			31	26
Dual-Panel Laminated, 0.030"			33	30
STC Upgrade			32	29
<b>Hinged Outswing Patio Doors - Single Panel</b>				
Dual-Pane	French panel with 4 11/16" stiles, 4 11/16" top rail & 12" bottom rail	37.875" x 84"	30	26
Triple-Pane			31	26
Dual-Panel Laminated, 0.030"			33	30
STC Upgrade			33	30
<b>Hinged Outswing Patio Doors - Two-Panel</b>				
Dual-Pane	French panels with 4 11/16" stiles, 4 11/16" top rail & 12" bottom rail	74.812" x 84"	29	25
Triple-Pane			30	26
Dual-Panel Laminated, 0.030"			33	30
STC Upgrade			32	29

\* "Sound Transmission Class (STC)" & "Outdoor/Indoor Transmission Class (OITC)" ratings are for individual units based on independent tests and represent entire unit.  
 • This data is accurate as of October 2018. Due to ongoing product changes, updated test results or new industry standards, this data may change over time.  
 • Contact your Andersen supplier for more information.

## Notes

A large grid area for taking notes, consisting of a 30x40 grid of small squares.

# Notes

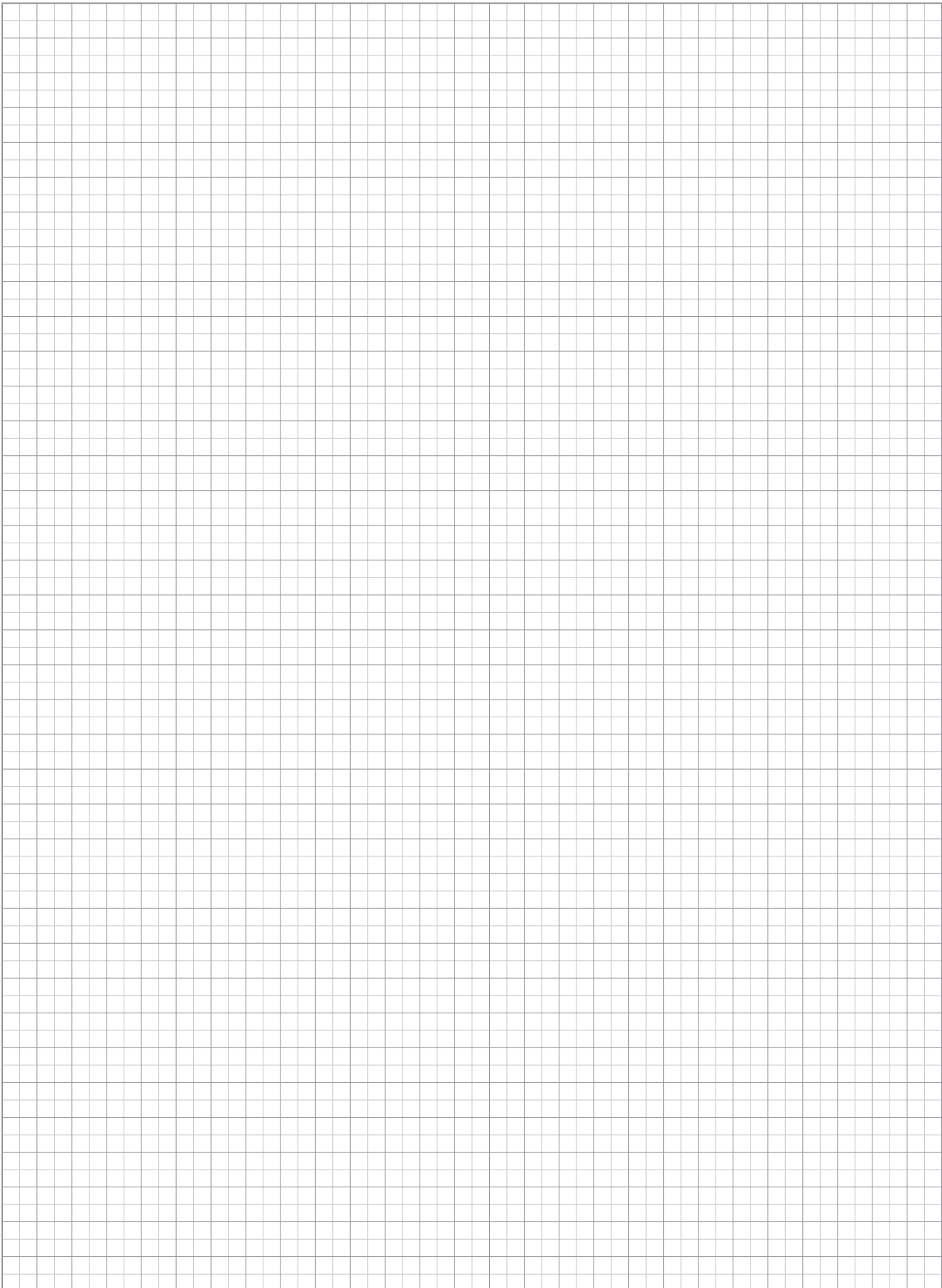



142	E-Series Gliding Patio Doors
106	E-Series Hinged Patio Doors
98	E-Series Specialty Windows
92	E-Series Gliding Windows
80	E-Series Bay & Bow Windows
56	E-Series Double-Hung Windows
48	E-Series Awning Windows
32	E-Series Casement Windows
154	Installation Material & Product Performance







## PDF NAVIGATION TIPS

Welcome to an overview of the enhanced navigation tools available in this PDF. Here are some simple tips on PDF navigation. Before you begin be sure you are using the latest version of Adobe Acrobat Reader DC, available at – <https://get.adobe.com/reader/>

To watch a 3-minute tutorial on navigating catalog PDFs, go to: <https://youtu.be/sWWnYn6ON3Y>

### BOOKMARK NAVIGATION

①

Acrobat will display the bookmarks panel when you open the PDF.

**Bookmarks** are the easiest way to find specific product information.

Select a topic and that page will be displayed.

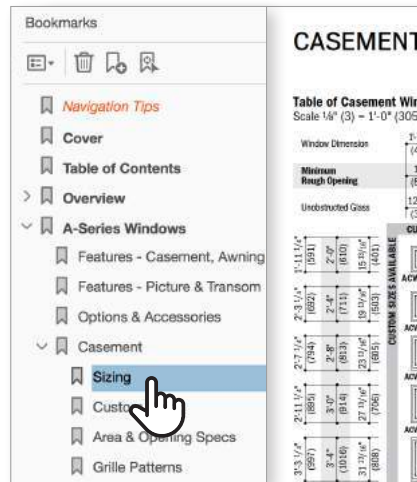

②

If you need to print a specific section, **right click on that section** within in the bookmarks panel and choose “**Print Section.**”

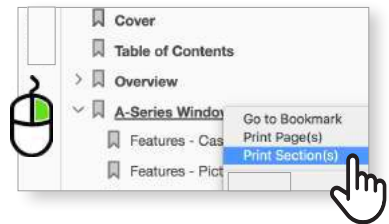

### LINKS AND URL NAVIGATION

①

You can also use the **embedded links** to navigate between sections. All links are underlined in blue.

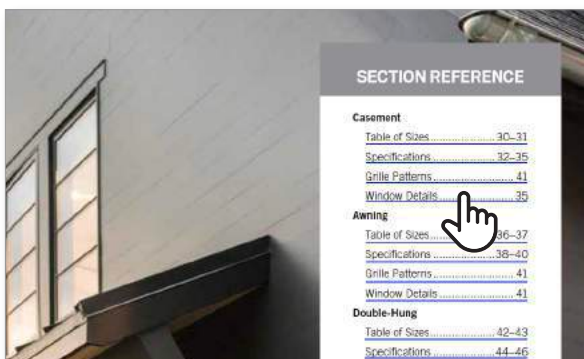

②

Website links automatically open in your web browser.



The tilt-in feature of A-Series allows one-hand operation

Add additional navigation tools by adjusting the default settings in Acrobat.

## TOOL BAR NAVIGATION

1

To add a **“Jump Back” Button** to your tool bar, **right click on tool bar**, select **Show Page Navigation Tools** and choose **Show All Page Navigation Tools**.

Right and left facing arrows are added to the tool bar allowing you to go back or forward to the last page you viewed.

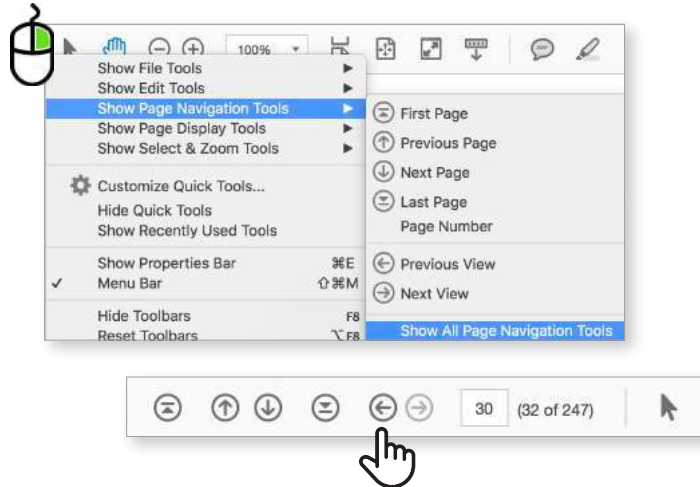

2

Another helpful tool is the **Loupe Tool**. It allows you to zoom in on the page without having to increase the page size.

To add a **Loupe Tool** to your tool bar, **right click on tool bar**, select **Show Select & Zoom Tools** and then choose **Show All Select & Zoom Tools**.

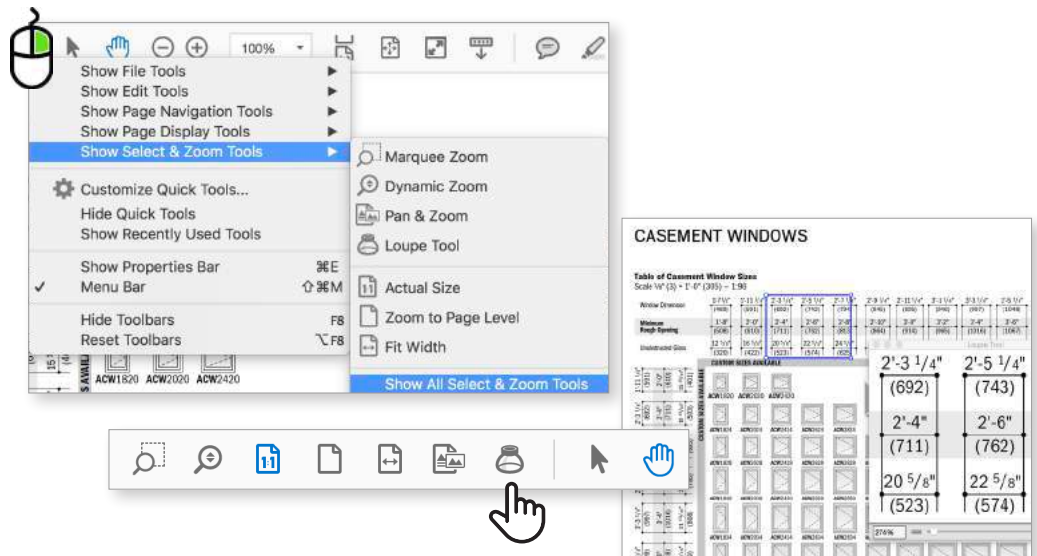

3

You can also use the **commenting tools**. Add a post-it-note with your comments or highlight important information.

Be sure to save the file.



To watch a 3-minute tutorial on navigating catalog PDFs, go to: <https://youtu.be/sWWnYn60N3Y>

We are always looking for ways to improve.  
Please send feedback to [webmarketing@andersencorp.com](mailto:webmarketing@andersencorp.com).